



Work lighting



Outdoor lighting



Indoor lighting



Home appliances



GENERAL CATALOGUE  
**2022**

**VELAAMP**<sup>®</sup>



## Une histoire Italienne

Nées en 1906, les industries FRATELLI PAGANI ont accompagné le développement industriel de l'Italie depuis le début du siècle dernier.

Première usine de batterie en Italie, la compagnie lance et développe la première lampe portable au Monde. C'est le début d'une longue série d'innovations dans le domaine de la lumière portable:

- Invention de la première lampe torche.
- Création de la première lampe anti black-out
- Invention de la lampe frontale
- Invention de la lampe dynamo.

Le siège actuel de VELAMP INDUSTRIE, présente une superbe exposition des produits VELAMP depuis le début de l'aventure en 1906.

Les usines FRATELLI PAGANI, seront totalement détruites en 1943, par les bombardements des forces alliées. Après la seconde guerre mondiale, l'Italie est en pleine reconstruction, comme une grande partie de l'Europe. C'est la période du « Miracle Italien », le pays connaît un boom économique incroyable et les industries FRATELLI PAGANI, se lancent dans la production entre autre de lampes torche et lampes professionnelles pour les plus grandes marques du marché : Philips, Varta, Duracell, Rayovac...

La marque VELAMP a été créée en 1972 dans le but de permettre à l'entreprise de distribuer ses propres produits sous sa marque. Depuis ce moment, VELAMP n'a cessé de créer et d'innover dans le domaine de la lumière portable.

Pionnier sur son marché, VELAMP a toujours adapté ses produits aux évolutions techniques (Ex : arrivée des ampoules LED...) et anticipé la demande des consommateurs avec des produits designs et innovants.

Aujourd'hui, l'entreprise VELAMP INDUSTRIES, propriétaire de la marque VELAMP, entend bien poursuivre cette formidable histoire industrielle en se proposant sur le marché en tant que :

- Spécialiste de la lumière portable et de chantier
- Généraliste de l'éclairage
- Généraliste du matériel électrique

La force de ses valeurs (solidarité, progrès et performance), fait de VELAMP un acteur majeur de son marché, responsable et avant-gardiste pour toujours.



## Una historia italiana

VELAMP nació en 1972. Es acrónimo de VENEGONO LAMPADE, ciudad de la gran fábrica de equipos agrícolas FRATELLI PAGANI spa. Nació en 1906, las industrias FRATELLI PAGANI, han acompañado el desarrollo industrial italiano desde principios del siglo pasado.

Primera fábrica de baterías en Italia, la Compañía desarrolla y pone en marcha la primera lámpara portátil en el mundo. Este es el comienzo de una larga serie de innovaciones en el ámbito de la luz portátil:

- Invención de la primera antorcha.
- Creación de la primera luz de seguridad
- Invención de la luz frontal
- Invención de la lámpara con dinamo.

La sede actual de VELAMP INDUSTRIA, tiene una magnífica exposición de productos VELAMP desde el comienzo de la aventura en 1906.

Las fábricas FRATELLI PAGANI, seran completamente destruida en 1943 por los bombardeos de las fuerzas aliadas. Después de la Segunda Guerra Mundial, Italia se está reconstruyendo, al igual que gran parte de Europa. Este es el período del "milagro italiano", el país está viviendo un auge económico increíble y las industrias FRATELLI PAGANI lanzan la producción, entre otras de lámparas y luces de trabajo profesionales para las marcas más importantes del mercado: Philips, varta, Duracell Rayovac...

VELAMP fue creado con el fin de poder distribuir estos productos con su marca en el mercado italiano. Desde entonces VELAMP ha continuado a innovar en el campo de la lámpara portátil. Pionera en su mercado, VELAMP siempre ha adaptado sus productos a los avances técnicos (por ejemplo, la llegada de las bombillas LED ...) y ha anticipado la demanda de los consumidores con diseño y productos innovadores.

Hoy en día la empresa VELAMP INDUSTRIES, es propietaria de la marca.

Hoy, VELAMP INDUSTRIES SRL, propietaria de la marca VELAMP, tiene la intención de continuar esta historia proponiéndose en el mercado como:

- Especialista en productos de iluminación portátiles y de construcción.
- Generalista de iluminación...
- Generalista de material eléctrico.

La fuerza de sus valores (solidaridad, progreso y rendimiento), hace de VELAMP un importante actor en el mercado, responsable y con visión de futuro para siempre.



## Eine italienische Geschichte

VELAMP entstand 1972 als Abkürzung von VENEGONO LAMPADE nach dem Ort, wo sich das größte Produktionswerk der damaligen FRATELLI PAGANI Spa befand. Das Unternehmen FRATELLI PAGANI hat seit 1906 die Entwicklung Italiens das ganze letzte Jahrhundert hindurch begleitet.

Als erste Batterie-Fabrik Italiens begann das Unternehmen, in die Entwicklung der weltweit ersten Taschenlampen zu investieren. Es folgte eine Reihe von Innovationen, die noch bis heute fort dauern:

- Entstehung der ersten Taschenlampe
- Entstehung der ersten Anti-Blackout-Lampe
- Schaffung der ersten Stirnlampe
- Erfindung der ersten Dynamolampe

Frattelli Pagani begleitete auch die Geschichte des Landes als Hersteller für die Streitkräfte.

1943 wird das Hauptwerk des Unternehmens von englischen und amerikanischen Bombern völlig zerstört. Nach dem Zweiten Weltkrieg erfand sich der Betrieb neu. Es sind die Jahre des „italienischen Wunders“, und der Betrieb beginnt, Taschenlampen hauptsächlich für die bekanntesten Namen dieses Sektors zu produzieren: Duracell, Rayovac, Varta Philips...

VELAMP wurde geschaffen mit dem Ziel, dem Betrieb ein italienisches Markenzeichen zu geben. Seitdem hat VELAMP sich weiterentwickelt und die Innovation vorangetrieben, um immer neue Antworten für den Bedarf an tragbarem Licht bereitzuhalten.

Als Pionier auf dem Markt hat es VELAMP immer verstanden, sofort auf die technischen Revolutionen (Entwicklung des Tauchens, Erfindung der LED...) zu reagieren, um dem Markt zuvorzukommen und immer effizientere Produkte in immer neuem Design anzubieten.

Heute will VELAMP INDUSTRIES SRL, Inhaber der Marke VELAMP, diese Geschichte fortsetzen und präsentiert sich auf dem Markt als:

- Ein Spezialist für mobile Beleuchtung und Arbeitsplatzbeleuchtung
- Ein Allrounder der Beleuchtung
- ein Anbieter für Elektromaterialien

Die Stärke seiner Werte (Solidarität, Fortschritt, Leistung) machen VELAMP zu einem wichtigen Akteur auf dem Markt: voller Verantwortung und einen Schritt voraus. Immer.



# Una storia italiana



VELAMP nasce nel 1972 come acronimo di VENEGONO LAMPADE, sito della maggiore unità produttiva dell'allora Fratelli Pagani Spa. Nata nel 1906, la Fratelli Pagani ha accompagnato l'evoluzione dell'Italia lungo tutto il secolo.

Prima fabbrica di batterie nel Bel Paese, l'azienda cominciò ad investire per sviluppare le prime lampade portatili. Cominciò una lunga serie di innovazioni ancora in uso:

- Nascita del primo astuccio
- Nascita della prima lampada antiblack-out
- Creazione della prima lampada da testa
- Invenzione della lampada a dinamo.

Fratelli Pagani accompagnò anche la Storia del paese: produttore per le forze armate, il suo principale stabilimento fu rasato al suolo nel 1943 dai bombardieri anglo-americani. Dopo guerra l'azienda si reinventò e seguendo il miracolo italiano cominciò a produrre lampade portatili principalmente per i nomi più conosciuti del mestiere: Duracell, Rayovac, Varta, Philips... VELAMP fu creata per dare un marchio italiano all'azienda.

Da allora VELAMP ha continuato ad evolvere ed innovare per dare delle risposte sempre più nuove ai bisogni di lighting portatile dei consumatori. Pioniere sul mercato, VELAMP ha sempre saputo interpretare le rivoluzioni tecniche (sviluppo del sub, arrivo del LED...) per anticipare il mercato e proporre prodotti sempre più design ed efficienti.

Oggi, VELAMP INDUSTRIES SRL, proprietaria del marchio VELAMP, intende continuare questa storia proponendosi sul mercato come:

- Specialista dei prodotti di illuminazione portatile e da cantiere
- Generalista dell'illuminazione
- Generalista del materiale elettrico

Forte dei suoi valori: Solidarietà, Progresso, Performance, VELAMP si propone come un attore fondamentale del mercato: responsabile e all'avanguardia. Sempre.



## An italian tale

VELAMP was born in 1972 as an acronym of VENEGONO LAMPADE, town of the biggest production plant of former Fratelli Pagani Spa. Founded in 1906, Fratelli Pagani has accompanied the evolution of Italy throughout the century.

First battery factory in Italy, the firm started to invest and developed the first portable lamps. So started a long series of innovative products that will still use everyday:

- Invention of the first flashlight
- Creation of the first anti black-out lamp
- Invention of the first headlamp
- Invention of dynamo lamp

Fratelli Pagani was an actor in Italian History: as a supplier of the Italian armed forces its main factory was totally destroyed by the anglo-american bombings in 1943. After WWII the Company started its business from scratch and following the "Italian Miracle" produced portable lamps, mainly for the major actors of the market: Duracell, Rayovac, Varta, Philips....

VELAMP was created with the aim to give an Italian brand to the Company.

From this moment on VELAMP has continued to evolve and innovate, so as to give answers to the always renewed needs for portable lighting. Pioneer on its market, VELAMP has always known how to interpret the technical evolutions (development of scuba diving, invention of the LED...) to anticipate the market and offer design and innovative products.

Today, VELAMP INDUSTRIES SRL, owner of the VELAMP brand, intends to continue this story, presenting itself on the market as:

- A specialist of the portable and jobsite lighting
- A generalist of the lighting
- A generalist of the electrical materials

The strength of its values (Solidarity, Progress, Performance) makes VELAMP a fundamental actor on this market: responsible and one step ahead. Always.





## Work lighting

<b>TORCE E ASTUCCI PER IL BRICOLAGE</b> <i>DIY pocket lamps and flashlights / Lampes de poche et torches pour le bricolage / Linternas y petacas para bricolaje / Fackeln und bricolage koffer</i>	<b>Pag. 6</b>				
		pag. 6	pag. 8	pag. 14	pag. 15
<b>LUCI FRONTALI</b>	<b>Pag. 11</b>				
<i>Headlamps / Lumières frontales / Iluminacion frontales / Stirnleuchten</i>					
<b>LAMPADIE DA LAVORO PER IL BRICOLAGE</b>	<b>Pag. 13</b>				
<i>Worklights for DIY / Lampes de travail portatives pour le bricolage / Lamparas portatiles para bricolaje / Arbeitsscheinwerfer selber machen</i>					
<b>FARI PER IL BRICOLAGE</b>	<b>Pag. 17</b>				
<i>DIY spotlights / Phares pour le bricolage / Focos de bricolaje / Scheinwerfer selber machen</i>					
<b>FARI USO PROFESSIONALE</b> <i>Professional spotlights / Phares pour usage professionnel / Focos para uso profesional / Arbeitsleuchten</i>	<b>Pag. 22</b>				
<b>PROIETTORI A BATTERIE PER IL BRICOLAGE</b>	<b>Pag. 24</b>				
<i>Battery operated floodlights for DIY / Projecteurs à batteries pour le bricolage / Projectores a batería para bricolaje / Akkubetriebener Projektor für Heimwerker</i>					
<b>PROIETTORI FILARI PER IL BRICOLAGE</b>	<b>Pag. 26</b>				
<i>Wired floodlights for DIY / Projecteurs filaires pour le bricolage / Projectores con cable para bricolaje / Kabelgebundene Projektoren für Heimwerker</i>					
<b>BERRETTI E CAPPELLINI LED RICARICABILI</b>	<b>Pag. 31</b>				
<i>Rechargeable LED beanies and caps / Bonnets et casquettes LED rechargeables / Gorros y gorras LED recargables / Wiederaufladbare LED-Mützen und -Kappen</i>					



## Outdoor lighting

<b>PLAFONIERE STAGNE</b> <i>Waterproof lights / Réglettes IP65 / Plafones de techo para exterior / Wannenleuchten</i>	<b>Pag. 42</b>				
		pag. 45	pag. 51	pag. 55	pag. 60
<b>PLAFONIERE TONDE</b> <i>Ceiling lamps / Plafonniers / Plafon / Deckenlampe</i>	<b>Pag. 48</b>				
<b>APPLIQUE DA ESTERNO</b> <i>Bulkheads / Hublots / Applique / Wandleuchte</i>	<b>Pag. 54</b>				
<b>SPOT DA ESTERNO</b>	<b>Pag. 62</b>				
<i>Outdoor spotlights / Spots extérieurs / Focos de exterior / Außenstrahler</i>					
<b>PROIETTORI SMD</b> <i>SMD spotlights / Projecteurs SMD / Projectores SMD / SMD-Strahler</i>	<b>Pag. 68</b>				
<b>CATENARIE LUMINOSE</b> <i>Extendable light chains / Guirlandes lumineuses / Guiraldas luminosas / Ausziehbare Lichterkette</i>	<b>Pag. 74</b>				
<b>LUCI PER IL GIARDINO</b>	<b>Pag. 83</b>				
<i>Garden lights / Lumières d'extérieur / Luces para jardín / Gartenleuchten</i>					
<b>SOLARE &amp; AUTONOMO</b> <i>Solar lighting / Éclairage solaire / Iluminacion con carga solar / Solarbeleuchtung</i>	<b>Pag. 93</b>				
					
		pag. 94	pag. 100	pag. 105	pag. 112



## Indoor lighting

**LAMPADINE LED** / LED Bulbs collection / Collection Ampoules LED / Colección de bombillas LED / Sammlung von LED-Lampen **Pag. 114**

**REGLETTE LED** / LED bar lights / Réglettes LED / Regletas de LED / LED-Linienlampen **Pag. 128**

**PANNELI LED** / LED panels / Panneaux LED / Paneles de LED / LED-panels **Pag. 130**

**PLAFONIERE TONDE** / Ceiling lamps / Plafonniers / Plafon / Deckenlampe **Pag. 132**

**SOSPENSIONI** / Lamp holders / Suspensions / Lamparas de suspensión / Lampenhalterungen **Pag. 140**

**LAMPADE DA TAVOLO** / Desk lamps of bureau / Flejos / Tischlampen **Pag. 142**

**LAMPADE CON LENTE** / Magnifier lamps / Lampes avec loupe / Lamparas con lupa / Lupenleuchten **Pag. 150**

**LUCI DA LETTURA** / Reading lights / Lampes de lecture / Luces de lectura / Leselichter **Pag. 155**

**LUCI DI SICUREZZA FISSE** / Wall emergency lamps / Blocs de secours / Luminarias par iluminación de emergencia / Sicherheitswandleuchten **Pag. 157**

**LUCI DI SICUREZZA PORTATILI** / Portable emergency lamps / Lampes portatives rechargeables anti coupures de courant / Lamparas recargables portátiles anti black-out / Tragbare Notleuchten **Pag. 160**

**LUCI NOTTURNE** / Nightlights / Veilleuses / Luzes nocturnas / Nachtlampen **Pag. 164**

**LUCI PER ARMADI** / Closet lighting / Lumières pour armoires / Luzes de armarios / Schrankbeleuchtung **Pag. 168**

**TORCE USO DOMESTICO** / Flashlights for domestic use / Lampes torches pour usage domestique / Linternas para uso domestico / Taschenlampen für den Hausgebrauch **Pag. 173**



## Home appliances & electric materials

**RISCALDATORI** / Domestic fan heaters / Petit chauffage domestique / Calefactores domesticos / Kleine Heizlüfter für den Hausgebrauch **Pag. 176**

**VENTILATORI** / Fans / Ventilateurs / Ventiladores / Ventilatoren **Pag. 183**

**ANTIZANZARE** / Mosquito killers / Moustiquaires électriques / Red mosquito eléctricos / Elektrisches Moskitonetz **Pag. 194**





<b>DOMOTICA</b> <i>Domotics / Domotique / Domotica / Domotik</i>	<b>Pag. 202</b>
 <b>SPINE, PRESE E ADATTATORI</b>	<b>Pag. 206</b>
 <b>MULTIPRESE ELETTRICHE</b>	<b>Pag. 210</b>
 <b>PROLUNGHE ELETTRICHE</b>	<b>Pag. 213</b>
  <b>AVVOLGITORI</b>	<b>Pag. 215</b>
 <b>FICHES ET PRISES</b>	<b>Pag. 218</b>
 <b>BLOCS MULTIPRISES</b>	<b>Pag. 219</b>
 <b>PROLONGATEURS</b>	<b>Pag. 220</b>
 <b>ENROULEURS BRICOLAGE</b>	<b>Pag. 222</b>
<b>MULTIMETRI DIGITALI</b> <i>Digital multimeters / Multimètres digitaux / Multimetros digitales / Digitales Multimeter</i>	<b>Pag. 223</b>
<b>CERCAFASE</b> <i>Voltage testers / Testeurs de voltage / Comprobares de voltajes / Spannungsprüfer</i>	<b>Pag. 224</b>
<b>MORSETTIERE PER CAVI ELETTRICI</b> <i>Terminals blocks / Bornes de raccordement / Regleta Clema / Anschlussklemme für elektrische Kontakte</i>	<b>Pag. 225</b>
<b>FASCETTE PER CABLAGGIO IN NYLON</b> <i>Nylon Cable ties / Serre-câbles en nylon / Bidas Nylon / Nylonkabelbinder</i>	<b>Pag. 226</b>
<b>ACCESSORI VARI</b> <i>Electrical accessories / Accessoires divers / Varios accesorios / Verschiedenes Zubehör</i>	<b>Pag. 229</b>
<b>CAVI DI RETE E ACCESSORI</b> <i>Network cables and accessories / Câbles réseau et accessoires / Cables y accesorios de red / Netzwerkkabel und Zubehör</i>	<b>Pag. 230</b>
<b>ESPOSITORI DA BANCO</b> <i>Displays / Présentoirs / Expositores / Display</i>	<b>Pag. 232</b>
<b>LUMINI VOTIVI</b> <i>Votive lights / Lumières votives / Velas votivas / Votivlichter</i>	<b>Pag. 239</b>
<b>PILE ZINCO CARBONE</b> <i>Zinc-Carbon / Salines / Salinas / Zink-Kohle</i>	<b>Pag. 244</b>
<b>PILE ALCALINE</b> <i>Alkaline / Alkaline / Alcalinas / Alkaline</i>	<b>Pag. 245</b>
<b>PILE LITIO</b> <i>Lithium / Lithium / Lítio / Lithium</i>	<b>Pag. 247</b>
<b>PILE RICARICABILI</b> <i>Rechargeable / Rechargeables / bRecarcables / Batterieladegerät</i>	<b>Pag. 249</b>
<b>BATTERIE AL PIOMBO RICARICABILI</b> <i>Rechargeable lead acid batteries / Batteries au plomb rechargeables / Baterias recargables al plomo / Wiederaufladbare Bleibatterien</i>	<b>Pag. 250</b>
<b>Energizer</b>	<b>Pag. 252</b>



Le immagini sono fornite al solo scopo illustrativo e non costituiscono elemento contrattuale. Velamp Industries S.r.l. si riserva di apportare, in qualsiasi momento, ogni modifica ritenuta necessaria.  
 All images are for illustrative purposes only and do not constitute a contractual element. Velamp Industries S.r.l. reserves the right, in any given moment, to make necessary changes if required.  
 Photos et caractéristiques non contractuelles. Velamp Industries et ses filiales se réservent le droit de modifier sans préavis les caractéristiques techniques ou esthétiques de tout produit.  
 Las imágenes tienen fin ilustrativo y no constituyen elementos contractuales. Velamp Industries S.r.l. se reserva el derecho a efectuar en cualquier momento y sin previo aviso las modificaciones que considere oportunas. Die Bilder dienen der Veranschaulichung und stellen keine vertraglichen Inhalte dar. Velamp Industries S.r.l. behält sich das Recht vor, jederzeit technische Änderungen und Änderungen am Design vorzunehmen.



**Work lighting**



### PENLED05 - PENLITE LED

Penna luminosa LED  
LED penlight  
Crayon lumineux LED  
Boligrafo LED  
LED-Minitaschenlampe

0,5W

**NEW**



PENLED05



COD.									Packing	Inner Pces	Master Pces
<b>PENLED05</b>	1 Super LED 0,5W	30 Lm	6 m	> 50 hrs	Focus light	136 x 140 mm	2 x AAA/LR03 (not included)	AL	Blister F2	12	96

### IF06B

Lampada da ispezione 3 LED con clip e calamita  
3 LED inspection light with clip and magnet  
Lampe d'inspection 3 LED avec clip et aimant  
Lámpara de inspección 3 LED avec clip y iman  
Inspektionslampe 3 LED mit Clip und Magnet

**VELAMP**  
BASICS



MAGNET HEAD - TESTA CALAMITA

MAGNET BASE - BASE CALAMITA

MAX: 57 cm



IF06B



COD.									+	Packing	Inner Pces	Master Pces
<b>IF06B</b>	3 LED Standard	10 Lm	10 mt	3 hrs	Focus light	22 x 15 x 170 mm	4 x LR44 (included)	AL	Magnet base, magnet head, Clip	Blister F6	12	48

### IS314 - PROLED

Penlite LED con clip  
LED penlite with clip  
Penlite LED avec clip  
Linterna boligrafo LED  
Penlite LED mit Clip

**NEW**

3W  
COB



1W LED

3W COB

STRONG MIGHTS

ROTABLE CLIP



IS314



COD.									Packing	Inner Pces	Master Pces
<b>IS314</b>	3W COB 1W High power LED	Panel: 150 Lm Flashlight: 40 hrs	15 m	Panel: 15 hrs Flashlight: 26 hrs	Diffuse + Focus light	181 x 35 x 19 mm	3 x AAA/LR03 (not included)	ABS	Display: 6 pces of Blister F5	6	48



## TORCE E ASTUCCI PER IL BRICOLAGE

DIY pocket lamps and flashlights / Lampes de poche et torches pour le bricolage /  
Linternas y petacas para bricolaje / Fackeln und bricolage koffer



### RUBBER LED

Torcia rubber LED

Rubber LED flashlight

Torche LED en caoutchouc

Linterna LED de caucho natural

LED-Taschenlampe aus Kautschuk



IRUB1LED



COD.										+	Packing	Inner Pcs	Master Pcs
<b>IRUB1LED</b>	3 Super LED	12 Lm	20 mt	30 hrs	Focus light	150 x 42 ø mm	2 x AA/LR6 (not included)	Rubber	Wrist band		Blister F2	12	72

### RUBBER LED

Torcia rubber LED

Rubber LED flashlight

Torche LED en caoutchouc

Linterna LED de caucho natural

LED-Taschenlampe aus Kautschuk



IRUB2LED



COD.										+	Packing	Inner Pcs	Master Pcs
<b>IRUB2LED</b>	3 Super LED	12 Lm	30 mt	30 hrs	Focus light	205 x 73 ø mm	2 x D/LR20 (not included)	Rubber	Wrist band		Blister F6	12	48

### RUBBER LED

Torcia rubber LED

Rubber LED flashlight

Torche LED en caoutchouc

Linterna LED de caucho natural

LED-Taschenlampe aus Kautschuk



IRUB3LED



COD.										+	Packing	Inner Pcs	Master Pcs
<b>IRUB3LED</b>	3 Super LED	12 Lm	30 mt	30 hrs	Focus light	270 x 73 ø mm	3 x D/LR20 (not included)	Rubber	Wrist band		Blister F5	12	48



### IN240 - ADVENTURE

Torcia metallica 9 LED  
 9 LED metal flashlight  
 Torche métallique 9 LED  
 Linterna de metal LED 9LED  
 Metalltaschenlampe 9 LED



IN240



COD.									IP	+	Packing	Inner Pces	Master Pces
<b>IN240</b>	9 Super LED	25 Lm	>20 mt	15 hrs	Focus light	100 x 32 ø mm	3 x AAA/LR03 (not included)	AL	IPX4	Folder	Blister F2	6	48

### IM42 - KOST

Torcia LED 3W CREE®  
 3W CREE® LED flashlight  
 Torche 3W CREE® LED  
 Linterna de LED 3W CREE®  
 Taschenlampe 3W CREE® LED

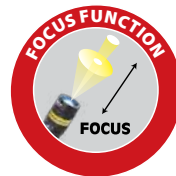

IM42



COD.									IP	Packing	Inner Pces	Master Pces
<b>IM42</b>	3W CREE® XPE R3 LED	140 Lm	120 mt	12 hrs	Adjustable	28 x 28 x 156 mm	2 x AA/LR6 (not included)	AL	IPX5	Blister F2	6	72

## TORCE E ASTUCCI PER IL BRICOLAGE

DIY pocket lamps and flashlights / Lampes de poche et torches pour le bricolage /  
Linternas y petacas para bricolage / Fackeln und bricolage koffer



Work lighting

### IN247 - STEEL 10W

Torcia con zoom in alluminio LED 10W  
10W LED aluminium flashlight with zoom  
Torche en aluminium 10W LED avec zoom  
Linterna de metal 10W LED con zoom  
Aluminium-Taschenlampe 10W LED mit Zoom



IN247



COD.									+	Packing	Inner Pces	Master Pces
<b>IN247</b>	10W High power LED	350 Lm	300 mt	24 hrs	Focus / Diffuse Light	40 x 40 x 137 mm	3 x AAA/LR03 (not included)	AL	Wrist band	Blister F2	6	48

### IR547 - STEEL RECHARGEABLE 10W

Torcia con zoom in alluminio LED 10W  
10W LED aluminium flashlight with zoom  
Torche en aluminium 10W LED avec zoom  
Linterna de metal 10W LED con zoom  
Aluminium-Taschenlampe 10W LED mit Zoom



IR547



COD.									Packing	Inner Pces	Master Pces
<b>IR547</b>	10W High power LED	350 Lm	300 mt	2 hrs	Focus / Diffuse Light	40 x 40 x 137 mm	- 3 x AAA/LR03 (not included) - 18650 lithium battery: 3.7V 2000mAh (included)	AL	Suitcase	6	24



### LC350 - CHEMIN DE FER 2

Astuccio in plastica  
 Plastic pocket lamp  
 Lampe de poche en plastique  
 Petaca de plastico  
 Plastische Taschenlampe



RED FILTER GREEN FILTER



BACK VIEW



MORSE  
 BUTTON

LC350



COD.									+	Packing	Inner Pces	Master Pces
LC350	3 Super LED	15 Lm	15 mt	60 hrs	Focus light	124 X 70 X 43 mm	3R12 or 3 x AA (not included)	ABS + PC	3 x AA Adaptor / Morse button / Red and green filters	Shrink	6	24

### IS419 - WARNING

Triangolo luminoso LED con torcia e calamita  
 LED triangle with flashlight and magnet  
 Triangle LED lumineux avec torche et aimant  
 Triángulo LED luminoso con linterna e imán  
 ED Leuchtdreieck mit Taschenlampe und Magnet



2 in 1

IS419



COD.									+	Packing	Inner Pces	Master Pces
IS419	3W COB LED	300 Lm	15 mt	Central LED 100%: 15 hrs, Central LED 50%: 24 hrs	Focus light	95 x 30 x 95 mm	3 x AAA/LR03 (not included)	ABS	Magnet, metal hook	Blister F4	6	48

## BERRETTI E CAPPELLINI LED RICARICABILI

Rechargeable LED beanies and caps / Bonnets et casquettes LED rechargeables / Gorros y gorras LED recargables / Wiederaufladbare LED-Mützen und -Kappen

### IH510.DL

Lampada da testa LED 1W  
1W LED headlamp  
Lampe frontale, 1W LED  
Linterna de cabeza LED 1W  
Stirnlampe 1W LED



1W

IH510.DL



COD.									Packing	Inner Pces	Master Pces	
IH510.DL	1W high power LED	40 Lm	30 mt	10 hrs	Focus light	ø 42,5 x 93 mm	3 X AAA/LR03 (not included)	ABS	Flash, 100%, 50%	Blister F2	6	48

### IH522 - ZEUS

Lampada da testa COB LED  
LED COB headlamp  
Lampe frontale LED COB  
Linterna frontal LED COB  
LED-Stirnlampe COB

3W COB

IH522



COD.									Packing	Inner Pces	Master Pces
IH522	3W COB LED	120 Lm	5 mt	8 hrs	Diffuse light	58 x 39 x 43 mm	3 x AAA/LR03 (not included)	ABS	Blister F2	6	72



Work lighting

### IH523 - METROS

Lampada frontale 2W ricaricabile con interruttore a rilevazione di movimento  
 2W LED rechargeable headlamp with motion sensor switch  
 Lampe frontale 2W rechargeable avec interrupteur à détecteur de mouvement  
 Linterna frontal 2W recargable con interruptor y sensor de movimiento  
 Stirnleuchte mit 2W, wiederaufladbar, mit Bewegungsmelder für An / Aus



#### SENSOR LIGHT



Rechargeable



ANTIGLARE

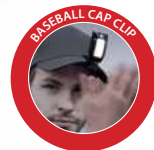

COD.									+	Packing	Inner Pcs	Master Pcs
IH523	2W COB LED	150 Lm	10 mt	High: 3 hrs Low: 6 hrs	Diffuse light	70 x 30 mm	Li-poly 500mAh 3.7V (included)	ABS + PC	50 cm USB cable	Blister F4	6	48

### IH535 - ARGO ZOOM EVO

Lampada da testa LED 6W con zoom  
 Head lamp LED 6W with zoom function  
 Lampe frontale LED 6W avec fonction zoom  
 Linterna frontal LED 6W con zoom  
 Stirnlampe LED 6W mit Zoomfunktion

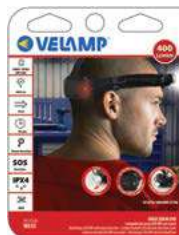

COD.									Packing	Inner Pcs	Master Pcs
IH535	6W CREE® XPG3	400 Lm	70 mt	High: 70 hrs Low: 40 hrs	Focus light + Diffuse light	90 x 70 x 75 mm	3 x AA/LR6 (not included)	ABS + PC + PMMA	Blister F4	6	36

## LAMPADE DA LAVORO PER IL BRICOLAGE

Worklights for DIY / Lampes de travail portatives pour le bricolage / Lamparas portatiles para bricolaje / Arbeitsscheinwerfer selber machen

### IS404 - TRANSFORMER

Luce da lavoro 3W LED COB  
3W LED COB worklight  
Lumière de travail 3W LED COB  
Luz de trabajo 3W LED COB  
Arbeitslampe 3W LED COB



IS404



COD.										Packing	Inner Pces	Master Pces
<b>IS404</b>	1 High power LED 0,5 W + 3W COB LED	30 Lm + 200 Lm	20 mt	35 hrs	Diffuse / Focus light	60 x 50 x 230 mm	3 x AA/LR6 (not included)	ABS + PS	Hook, magnet, bracket	Blister F5	6	48

### IR471 - DAVY

Lampada da lavoro LED ricaricabile multifunzione  
LED Rechargeable multifunction work lamp  
Lampe de travail multifonction rechargeable  
Lámpara para taller LED recargable  
Multifunktionale aufladbare LED Arbeitsleuchte



Rechargeable

IR471



COD.										Packing	Inner Pces	Master Pces
<b>IR471</b>	3W COB LED (panel) 3W LED (torch)	Panel: 150 Lm Torch: 60 Lm	2,5 hrs	Diffuse + Focus Light	155 x 40 x 20 mm	Li-Ion 3,7V 1200mAh (18650) (Included)	5V == 1000mA	ABS + PC	50 cm micro USB cable, Hook, Magnet	Display: 6 pcs of Blister F6	6	48



### IS475 - HANDY WORK

Lampada da lavoro ricaricabile multifunzione  
 Rechargeable multifunction work lamp  
 Lampe de travail multifonction rechargeable  
 Lámpara para taller LED recargable  
 Multifunktions-Arbeitslampe wiederaufladbar

3W



Rechargeable

IS475



COD.									Packing	Inner Pces	Master Pces
IS475	3W SMD LED (6 pcs)	300 Lm	8 hrs (50%) 4 hrs (100%)	Diffuse Light	Lamp: 58 x 40 x 240 mm Lamp+base: 70 x 100 x 265 mm	Li-Ion 3,7V 2200mAh (18650) (Included)	230V ~50 Hz 5V = 1A	ABS	Blister F5	6	24

### IR439 - KUBRIK

Lampada da lavoro LED ricaricabile multifunzione  
 LED rechargeable multifunction work lamp  
 Lampe de travail LED rechargeable multifonctions  
 Lámpara de trabajo multifunción LED recargable  
 Multifunktionale aufladbare LED Arbeitsleuchte

5W



Rechargeable



MAGNET



HOOK

IR439



COD.									+	Packing	Inner Pces	Master Pces
IR439	5W COB LED (panel) 3W High power LED (torch)	Panel: 350 Lm Torch: 150 Lm	3 hrs (panel) 5 hrs (torch)	Diffuse Light + focus	150 x 37 x 30 mm (folded size) 250 x 37 x 30 mm (expanded size)	Li-Ion 3,7V 2000mAh (18650) (Included)	5V = 1000A max	PC + AL	50 cm micro USB cable, Hook, Magnet	Display: 6 pcs of Blister F6	6	48



## LAMPADINE DA LAVORO PER IL BRICOLAGGIO

Worklights for DIY / Lampes de travail portatives pour le bricolage / Lamparas portatiles para bricolaje / Arbeitsscheinwerfer selber machen

### IR578 - BLACKMAN

Lampada da lavoro ricaricabile 3W COB LED  
3W LED COB Rechargeable worklight  
Baladeuse rechargeable 3W COB LED  
Lampara para taller recargable 3W COB LED  
Wiederaufladbare LED-Werkstattlampe

**NEW**



IR578



COD.										Packing	Inner Pcs	Master Pcs
<b>IR578</b>	3W COB LED	150 Lm	10 mt	4-8 hrs	Diffuse Light	377 x 40 x 40 mm	5V === 1A max (not included)	3.7V 2000 mAh Li-ion (Included) type 18650	ABS	Blister F8	6	24

### IS575 - LIGHT STICK

Lampada da lavoro ricaricabile 3W COB LED  
3W LED COB Rechargeable worklight  
Baladeuse rechargeable 3W COB LED  
Lampara para taller recargable 3W COB LED  
Wiederaufladbare LED-Werkstattlampe



IS575



COD.										Packing	Inner Pcs	Master Pcs
<b>IS575</b>	3W COB LED	250 Lm	5 mt	100%: 3 hrs 50%: 9 hrs	120°	57 x 50 x 410 mm	12V === 500mA	3.7V 1800 mAh Li-ion (Included) type 18650	ABS	Blister F8	6	24



### IS540 - WORKSHOP LED

Lampada da officina LED  
Workshop LED lamp  
Lampe de travail LED  
Lámpara para taller LED  
LED-Werkstattlampe



5m SMD LED



Insulation class



Containing product



IS540



COD.				Cable							Packing	Inner Pcs	Master Pcs
IS540	3W LED SMD 2835	300Lm	5 m	5m, H05VV-F 2x0.75mm <sup>2</sup>	Diffuse	460 x 36,5 x 36,5 mm	100-240V ~ 50 Hz	PP + PC + PVC	Hook	Polybag	12	24	

### WORKSHOP

Lampada da officina con gabbia metallica  
Workshop lamp with metal cage  
Lampe de travail avec cage métallique  
Lámpara para taller con jaula de metal  
Arbeitslampe mit Metallgitter



E27 NOT INCLUDED 5m 10 mt



Insulation class



IS525



IS529



COD.			Cable					Packing	Inner Pcs	Master Pcs
IS525	220-240V ~ 50 Hz	E27 max 60W (not included)	5 mt, H05VV-F 2x0.75mm <sup>2</sup>	325 x 90 x 90 mm	Hook	PVC / Metal	Polybag	12	24	
IS529	220-240V ~ 50 Hz	E27 max 60W (not included)	10 mt, H05VV-F 2x0.75mm <sup>2</sup>	325 x 90 x 90 mm	Hook	PVC / Metal	Polybag	12	24	

## FARI PER IL BRICOLAGE

DIY spotlights / Phares pour le bricolage / Focos de bricolaje / Scheinwerfer selber machen

### IRUB20LED - FARO RUBBER

Faro LED in caucciù naturale  
 Natural rubber LED spotlight  
 Phare LED en caoutchouc naturel  
 Faro LED de caucho natural  
 LED-Handleuchte aus natürlichem Kautschuk



0.5W



IRUB20LED



COD.									Packing	Inner Pcs	Master Pcs
IRUB20LED	1 High Power LED 0,5W	35 Lm	>20 mt	>100 hrs	Focus light	200 x 110 x 103 mm	2 x D/LR20 (not included)	Natural rubber	Bulk	6	24

### IR666-DRY DOOMSTER BASIC

Faro 1W LED  
 1W LED spotlight  
 Phare 1W LED  
 Projector LED 1W  
 Handleuchte 1W LED



1W



WORKS WITH:



IR666-DRY



COD.									+	Packing	Inner Pcs	Master Pcs
IR666-DRY	1W High power LED	100 Lm	>150 mt	40 hrs	Focus light	208 x 144 x 162 mm	4R25 or 4 x D (not included)	ABS NYLON	4 x LR20 Adaptor Carry strap	Plastic hanger	6	18



Work lighting

### IR551LED

Faro LED ricaricabile 1W  
Rechargeable 1W LED spotlight  
Phare 1W LED rechargeable  
Projector rechargeable LED 1W  
Handleuchte 1W LED wiederaufladbar



Rechargeable

IR551LED



COD.										Packing	Inner Pces	Master Pces
IR551LED	1W High Power LED	100 Lm	150 mt	>3 hrs	Focus light	182 x 106 x 145 mm	220V ~ 50Hz 5V → 1A	3.7V 800mAh (included)	ABS	Colour box	6	24

### IR554LED - ICARO 3W

Faro LED ricaricabile 3W  
Rechargeable 3W LED spotlight  
Phare 3W LED rechargeable  
Projector rechargeable LED 3W  
Handleuchte 3W LED wiederaufladbar



Rechargeable

IR554LED



COD.										Packing	Inner Pces	Master Pces
IR554LED	3W High Power LED	170 Lm	250 mt	High: 2 hrs Low: 5 hrs	Focus Light	178 x 105 x ø 140 mm	220V ~ 50Hz 5V → 1A	3.7V 2A (type 18650) (included)	PP	Colour box	6	24

## IR558 - HORNET 2

Faro LED ricaricabile 5W  
 Rechargeable 5W LED spotlight  
 Phare 5W LED rechargeable  
 Projector rechargeable LED 5W  
 Handleuchte 5W LED wiederaufladbar



LITHIUM BATTERY

5W



IP44

Rechargeable



Work lighting

COD.										Packing	Inner Pces	Master Pces
IR558	5W High Power LED + 3,5 COB LED	Spotlight: 350 Lm Crown Light: 300 Lm	400 mt	Spotlight: 2 hrs Crown Light: 2 hrs	Focus + Diffuse light	178 x 105 x 140 mm	220V ~ 50Hz 5V==1000mA	3.7V 2A (type 18650) (included)	PP	Colour box	6	24

## IR561 - CHURCHILL

Faro ricaricabile LED 10W  
 10 Watt LED rechargeable spotlight  
 Phare rechargeable LED 10 Watt  
 Projector rechargeable LED 10W  
 Wiederaufladbare Handleuchte LED 10 Watt



LITHIUM BATTERY

VELAMP BASICS



10W



IP44

Rechargeable



COD.										Packing	Inner Pces	Master Pces
IR561	10W High power LED	800 Lm	800 mt	15 hrs	Focus Light	166 x 143 x 210 mm	230V ~ 50Hz 5V==1A	3.7V 4,8A (type 18650) (included)	PP+ABS	Colour box	6	12

# DOOMSTER

UN FARO PENSATO PER DURARE

## PVC

Super resistente  
Anti urto  
Durabilità  
Antishock



## LED

High Power LED

## RIFLETTORE

Alto rendimento  
High performance  
reflector

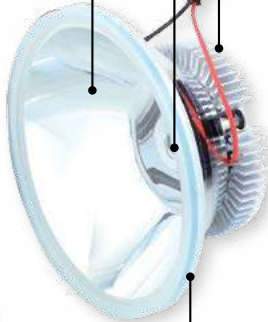

## ISOLAMENTO SILICONE

Silicon ring

## DISSIPATORE

In alluminio  
Aluminium heat sink

## SILICON RUBBER



## NYLON

Resistenza al calore  
Resistenza agli agenti  
chimici  
Resistenza all'abrasione  
Resistenza meccanica  
Chemical & mechanical  
resistance

## ABS

Antiurto  
Antishock

## GPPS

Trasparenza  
Transparency

## IMPUGNATURA ERGONOMICA

Ergonomic handle

## PRESA USB

### Powerbank 2A

USB powerbank



## CARICATORE

Charging jack

## LAMPEGGIANTE ROSSO

Red blink



## SUPPORTO REGOLABILE

Adjustable bracket



# CARATTERISTICHE



## RIFLETTORE

DOOMSTER garantisce profondità e distanza con i LED High Power la cui luminosità viene esaltata dal suo riflettore disegnato appositamente per questi componenti. Il riflettore garantisce un fascio preciso e focalizzato



## AUTONOMIA

Per motivi di durata, di tenuta in magazzino e di peso la serie DOOMSTER monta delle batterie Li-ion nuove, certificate e non rigenerate del tipo 18650 con connettore, da 2000mAh o 4000mAh.



## POWER BANK

DOOMSTER è un punto di riferimento in qualsiasi situazione. La sua capiente batteria gli permette di dare una ricarica anche completa a qualsiasi tablet o telefono vorrete collegare. (2A output) (Solo per alcuni modelli)



## SUPPORTO REGOLABILE

DOOMSTER è utilizzabile fino a 45° di elevazione: basta regolare l'apposito supporto. Tutti i fari DOOMSTER hanno il passo per installazione sui treppiede che si trovano in commercio. DOOMSTER è il prodotto con la maggior versatilità del mercato.



## LANTERNA COB

Per i professionisti che vogliono illuminare un locale o un area di lavoro, VELAMP ha pensato di usare la nuova tecnologia COB DLR per dare alla serie DOOMSTER una luce diffusa da 120°. Appoggiando la testa "rubber" su qualsiasi superficie, avrete una comoda lanterna e/o luce da lavoro per agire a mani libere. (Solo per alcuni modelli)



## ANTIBLACK-OUT

Tutti i fari ricaricabili DOOMSTER sono anti-blackout: saranno sempre pronti all'uso in qualsiasi momento. Basta collegarli alla corrente elettrica in posizione ON: si spegneranno e si accenderanno automaticamente in caso di mancanza di corrente. La base di carica a muro in dotazione col modello ST999-5W vi permetterà un'installazione in macchine, trucks, locali tecnici...



## LAMPEGGIANTE ROSSO

In caso di necessità (incidente, pericolo, SOS) è semplice segnalare la propria presenza con DOOMSTER: una pressione sul tasto secondario si accenderà una luce intermittenza rossa. (Solo per alcuni modelli)



## RESISTENZA

DOOMSTER è stato concepito per durare:

- IP44: può essere usato all'aperto in qualsiasi condizione atmosferica
- IK08: è resistente agli urti
- La sua fattura è garanzia di robustezza: corpo in nylon protetto da guscio in ABS + testa in PVC garantiscono resistenza agli urti, condizioni climatiche, agenti chimici, calore
- La testa in finitura "rubber" è stata concepita per assorbire gli urti in primis e come base di appoggio



## ACCESSORI

Tutti i fari DOOMSTER ricaricabili hanno in dotazione:

- Caricatore da auto e da 220V
- Cinghia di trasporto
- ST999-10L è fornito con la valigetta di trasporto
- IR666-DRY viene fornito con l'adattatore per 4 pile LR20 e/o 1 pila 4R25: comodo sui cantieri!



Work lighting

## IR666-5W - DOOMSTER POWER

Faro LED ricaricabile 5W  
 Rechargeable 5W LED spotlight  
 Phare 5W LED rechargeable  
 Projector rechargeable LED 5W  
 Handleuchte 5W LED wiederaufladbar

LITHIUM BATTERY



IR666-5W



COD.										Packing	Inner Pces	Master Pces
IR666-5W	High power LED 5W	350 Lm	574 mt	100%: 1.8 hrs 50%: 3.6 hrs	Focus light	208 x 144 x 162 mm	230V ~ 50Hz 5V == 500mA	3.7V 2000mAh Li-ion, Type 18650 (included)	ABS NYLON	Colour Box	6	18





# FARI USO PROFESSIONALE

Professional spotlights / Phares pour usage professionnel / Focos para uso profesional / Professionelle Scheinwerfer

## IR666-10W - DOOMSTER TREKK EVO

Faro LED ricaricabile 10W  
 Rechargeable 10W LED spotlight  
 Phare rechargeable LED 10W  
 Projector rechargeable LED 10W  
 Scheinwerfer LED 10W, wiederaufladbar



Work lighting



IR666-10W



COD.										Packing	Inner Pcs	Master Pcs
<b>IR666-10W</b>	High power LED 10W	735 Lm	>1000 m	Central LED: 100%: 1.4 hrs 50%: 2.8 hrs COB lantern: 100%: 2.5 hrs 50%: 5 hrs	Focus light	208 x 144 x 162 mm	230V~50Hz 5V==500mA	3,7V 2000mAh Li-ion, Type 18650 (included)	ABS NYLON	Color Box	6	18

## 20999

Base di ricarica da parete per fari serie Doomster  
 Wall charging base for Doomster spotlight  
 Base de chargement pour phares Doomster  
 Base de carga para los proyectores Doomster  
 Ladehalterung für Doomster-Handleuchte

20999



COD.	
<b>20999</b>	10,5 x 10,1 x 4,8 cm

WALL CHARGING BASE

### IS590 - XMEN

Proiettore LED a pile  
Dry battery operated LED floodlight  
Projecteur LED à piles  
Projector LED a pila  
Batteriebetriebene LED-Leuchte

5W 500 LUMEN



IS590



COD.			°K						Packing	Inner Pcs	Master Pcs
IS590	5W COB LED	Light 100%: 500Lm Light 50%: 200 Lm	6000K	Light 100%: 7 hrs Light 50%: 20 hrs	Diffuse 120°	170 x 125 x 45 mm	4 x AA/LR6 (not included)	ABS	Blister F5 + Display	6	24

### IR882 - THE EXPANDABLE

Faro ricaricabile LED  
LED rechargeable floodlight  
Projecteur LED rechargeable  
Projector LED recargable  
Baustrahler LED wiederaufladbar

10W 600 LUMEN



Rechargeable

IR882



COD.			°K							Packing	Inner Pcs	Master Pcs
IR882	10W SMD LED	600 Lm	6500K	2 hrs	Diffuse 100°	210 x 223 x 48 mm	AC/DC 5V 1A (included)	Li-Ion 3.7V 18650 2000mAh	AL + PP	Colour box	6	18

## PROIETTORI A BATTERIE PER IL BRICOLAGE

Battery operated floodlights for DIY / Projecteurs à batteries pour le bricolage / Projectores a batería para bricolaje / Akkubetriebener Projektor für Heimw



### IR827 - SAURON

Lampada da lavoro ricaricabile 20W COB LED  
 20W COB LED rechargeable worklight  
 Lumière de travail rechargeable 20W COB LED  
 Projector de trabajo recargable COB LED 20W  
 COB LED 20W Arbeitsleuchte



**20W**  
**1200 LUMEN**



Rechargeable

IR827



COD.			°K							Packing	Inner Pcs	Master Pcs
<b>IR827</b>	20W High Power COB LED	1200 Lm	6500K	High mode: 3 hrs Low mode: 6 hrs	Diffuse 100°	170 x 132 x 42 mm	AC/DC adaptor 5V == 2.0A max (not included)	2x 3,7V 2200mAh Li-ion (Type 18650) (included)	Aluminium + ABS + PC	Colour box	4	24

### IR867 - CYCLOP

Faro ricaricabile LED  
 LED rechargeable floodlight  
 Projecteur LED rechargeable  
 Projector LED recargable  
 Baustrahler LED wiederaufladbar

**20W**  
**1200 LUMEN**



Rechargeable

IR867



**VELAMP**  
patent pending



Funzione AC/DC: funziona mentre carica  
 AC/DC function: works while charging  
 AC/DC fonction: fonctionne pendant la charge  
 Funcion AD/DC: Funciona durante la carga  
 AC/DC-Funktion: Funktioniert während des Aufladens



COD.			°K							Packing	Inner Pcs	Master Pcs
<b>IR867</b>	20W LED COB	1200 Lm	6500K	3 hrs	Diffuse 120°	1216 x 183 x 280 mm	220/240V ~ 50 Hz 9V == 2500mA	7,4V 4400mAh, Li-ion Type 18650 (included)	Aluminium	Colour box	-	4

# LIGHT PAD 3 - 20W

Work lighting

20W

1600 LUMEN



25.000 hrs



Protection class



Insulation class



Containing product



intertek



Cod. Item code Code Codigo Code	Alimentazione Power source Alimentation Alimentación Stromversorgung	Tecnologia della Luce Light technology Technologie de la lumière Tecnología de iluminación Beleuchtungstechnologie	Potenza (W) Watt power Puissance Potencia Leistung	Lumen Lumen Lumen Lumen	Tipo di Luce Kelvin degrees Degrés Kelvin Temperatura de luz °K	Apertura Fascio Kind of beam Type de faisceau Tipo de haz Ausstrahlungswinkel	Materiale Material Materiau Material Material	Cavo Cable Cable Cable Kabel
<b>IS750-3</b>	220-240V ~ 50Hz	LED Epistar 2835	20W	1600 Lm	6500K	Diffuse 100°	ABS / AL	1,5 mt H05RN-F 3G1.0mm <sup>2</sup>

**Descrizione** / Description / Description / Descripción / Beschreibung:

Luce da lavoro LED 20W  
20W LED worklight  
Lumière de travail LED 20W  
Projector LED 20W  
LED-Arbeitslampe 20W

**Accessori inclusi** / Accessories included / Accessoires fournis / Accesorios incluidos / Mitgeliefertes Zubehör:



**Cavo** / Cable / Cable / Câble / Kabel:  
1,5 mt H05RN-F 3G1.0mm<sup>2</sup>

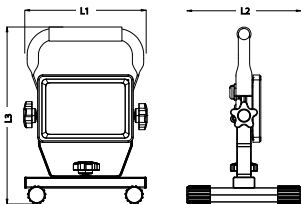

Codice Prodotto Item code Code Codigo Code	Lunghezza L1 Length Longueur Longitud Länge	Larghezza L2 Width Largeur Ancho Breite	Altezza L3 Height Hauteur Altura Höhe	Imballo Packing Emballage Embalaje Verpackung	Inner Pces	Master Pces
<b>IS750-3</b>	175 mm	165 mm	260 mm	Colour box	-	8

IS750-3



# PROIETTORI FILARI PER IL BRICOLAGE

Wired floodlights for DIY / Projecteurs filaires pour le bricolage / Projectores con cable para bricolaje / Kabelgebundene Projektoren für Heimwe

## WAINGRO

50W

4000 LUMEN



Work lighting



25.000 hrs



Protection class



Insulation class



Containing product



intertek



Cod. Item code Code Codigo Code	Alimentazione Power source Alimentation Alimentación Stromversorgung	Tecnologia della Luce Light technology Technologie de la lumière Tecnología de iluminación Beleuchtungstechnologie	Potenza (W) Watt power Puissance Potencia Leistung	Lumen Lumen Lumen Lumen Lumen	Tipo di luce Kelvin degrees Degrés Kelvin Temperatura de luz °K	Apertura Fascio Kind of beam Type de faisceau Tipo de haz Ausstrahlungswinkel	Materiale Material Materiau Material Material	Cavo Cable Cable Cable Kabel
<b>IS766</b>	220-240V ~ 50 Hz	LED SMD 2835	50W	4000 Lm	6500K	Diffuse 100°	ABS / AL	3 mt H05RN-F 3G1.0mm <sup>2</sup>

**Descrizione / Description / Description / Descripción / Beschreibung:**

Luce da lavoro LED 50W  
50W LED worklight  
Lumière de travail LED 50W  
Projector LED 50W  
LED-Arbeitslampe 50W

**Accessori inclusi / Accessories included / Accessoires fournis / Accesorios incluidos / Mitgeliefertes Zubehör:**



**Cavo / Cable / Cable / Câble / Kabel:** 3 mt H05RN-F 3G1.0mm<sup>2</sup>

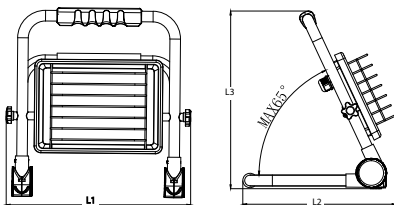

Codice Prodotto Item code Code Codigo Code	Lunghezza L1 Length Longueur Lungitud Länge	Larghezza L2 Width Largeur Ancho Breite	Altezza L3 Height Hauteur Altura Höhe	Imballo Packing Emballage Embalaje Verpackung	Inner Pces	Master Pces
<b>IS766</b>	331 mm	275 mm	318 mm	Colour box	-	4

IS766





Work lighting

# LIGHT PAD 2



max 1,68 mt

3 mt  
CABLE

20W

1600  
LUMEN



30.000 hrs



Protection class



Insulation class



Containing product



Cod. Item code Code Codigo Code	Alimentazione Power source Alimentation Alimentación Stromversorgung	Tecnologia della Luce Light technology Technologie de la lumière Tecnología de iluminación Beleuchtungstechnologie	Potenza (W) Watt power Puissance Potencia Leistung	Lumen Lumen Lumen Lumen Lumen	Tipo di luce Kelvin degrees Degrés Kelvin Temperatura de luz °K	Apertura Fascio Kind of beam Type de faisceau Tipo de haz Ausstrahlungswinkel	Materiale Material Materiau Material Material	Cavo Cable Cable Cable Kabel
IS749-2	100-240V ~ 50/60 Hz	LED Epistar 2835	20W	1600 Lm	6500K	Diffuse 120°	ABS / AL	3 mt H05RN-F 3G1.0mm <sup>2</sup>

**Descrizione / Description / Description / Descripción / Beschreibung:**

Luce da lavoro LED 20W SMD + treppiede  
20W SMD LED worklight + tripod  
Lumière de travail LED 20W + trépied  
Projector LED SMD + tripod  
LED-Arbeitslampe 20W + Stativ

Codice Prodotto Item code Code Codigo Code	Lunghezza L1 Length Longueur Lungitud Länge	Larghezza L2 Width Largeur Ancho Breite	Altezza L3 Height Hauteur Altura Höhe	Imballo Packing Emballage Embalaje Verpackung	Inner Pcs	Master Pcs
IS749-2	860 mm	680 mm	1710 mm	Colour box	-	4

IS749-2





# LIGHT PAD 3

Work lighting

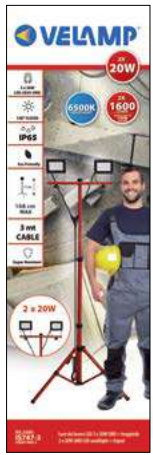

-  25.000 hrs
-  IP65 Protection class
-  Insulation class
-  Containing product
-  CE
-  Intertek

Cod. Item code Code Codigo Code	Alimentazione Power source Alimentation Alimentación Stromversorgung	Tecnologia della Luce Light technology Technologie de la lumière Tecnología de iluminación Beleuchtungstechnologie	Potenza (W) Watt power Puissance Potencia Leistung	Lumen Lumen Lumen Lumen	Tipo di luce Kelvin degrees Degrés Kelvin Temperatura de luz °K	Apertura Fascio Kind of beam Type de faisceau Tipo de haz Ausstrahlungswinkel	Materiale Material Materiau Material Material	Cavo Cable Cable Cable Kabel
<b>IS747-3</b>	220-240V ~ 50/60 Hz	2835 SMD LED	2 x 20W	2 x 1600 Lm	6500K	Diffuse 100°	AL	3 mt H05RN-F 3G1.0mm <sup>2</sup>
<b>TRIPOD</b>	-	-	-	-	-	-	AL	-

**Descrizione / Description / Description / Descripción / Beschreibung:**

Luce da lavoro LED 2 x 20W SMD + treppiede  
 2 x 20W SMD LED worklight + tripod  
 Lumière de travail LED 2 x 20W + trépied  
 Projector 2 x 20W LED SMD + tripode  
 LED-Arbeitslampe 2 x 20W + Stativ

Codice Prodotto Item code Code Codigo Code	Lunghezza L1 Length Longueur Lungitud Länge	Larghezza L2 Width Largeur Ancho Breite	Altezza L3 Height Hauteur Altura Höhe	Imballo Packing Emballage Embalaje Verpackung	Inner Pces	Master Pces
<b>IS747-3</b>	740 mm	740 mm	1760 mm	Colour box	-	4
<b>TRIPOD</b>	870 mm	870 mm	1650 mm	Colour Box	-	6

IS747-3



TRIPOD





# WAINGRO + TRIPOD

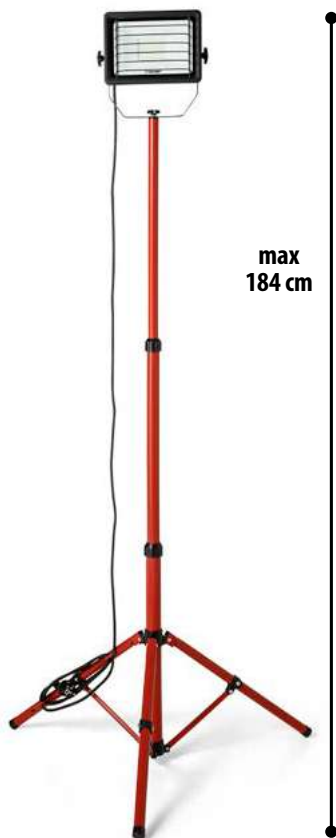

max  
184 cm

3 mt  
CABLE

50W

4000  
LUMEN



25.000 hrs



Protection class



Insulation class



Containing product



intertek

Cod. Item code Code Codigo Code	Alimentazione Power source Alimentation Alimentación Stromversorgung	Tecnologia della Luce Light technology Technologie de la lumière Tecnología de iluminación Beleuchtungstechnologie	Potenza (W) Watt power Puissance Potencia Leistung	Lumen Lumen Lumen Lumen	Tipo di luce Kelvin degrees Degrés Kelvin Temperatura de luz °K	Apertura Fascio Kind of beam Type de faisceau Tipo de haz Ausstrahlungswinkel	Materiale Material Materiu Material Material	Cavo Cable Câble Cable Kabel
IS746-50W	220-240V ~ 50 Hz	LED SMD 2835	50W	4000 Lm	6500K	Diffuse 100°	AL	3 mt H05RN-F 3G1.0mm <sup>2</sup>

**Descrizione / Description / Description / Descripción / Beschreibung:**

Luce da lavoro LED 50W SMD + treppiede  
50W SMD LED worklight + tripod  
Lumière de travail LED 50W + trépied  
Projector LED 50W SMD + tripode  
LED-Arbeitslampe 50W + Stativ

Codice Prodotto Item code Code Codigo Code	Lunghezza L1 Length Longueur Lungitud Länge	Larghezza L2 Width Largeur Ancho Breite	Altezza L3 Height Hauteur Altura Höhe	Imballo Packing Emballage Embalaje Verpackung	Inner Pces	Master Pces
IS746-50W	940 mm	940 mm	1840 mm	Colour box	-	2

IS746-50W





# LIGHTHOUSE

*Rechargeable LED beanies*





# USB RECHARGEABLE!

Work lighting



## CAP01 - LIGHTHOUSE

Berretto LED ricaricabile  
Rechargeable LED beanie  
Bonnnet LED rechargeable  
Gorro con luz LED recargable  
Mütze mit LED, wiederaufladbar



**LIGHT GREY**

CAP01



COD.									Packing	Inner Pcs	Master Pcs
<b>CAP01</b>	SMD LED	100 Lm	20 m	2 hrs	Focus light	220 x 200 mm	Lithium polymer 250 mAh (included)	100% Acrylic	Plastic hanger	6	48

## CAP02 - LIGHTHOUSE

Berretto LED ricaricabile  
Rechargeable LED beanie  
Bonnnet LED rechargeable  
Gorro con luz LED recargable  
Mütze mit LED, wiederaufladbar



**DARK GREY**

CAP02



COD.									Packing	Inner Pcs	Master Pcs
<b>CAP02</b>	SMD LED	100 Lm	20 m	2 hrs	Focus light	220 x 200 mm	Lithium polymer 250 mAh (included)	100% Acrylic	Plastic hanger	6	48

## CAP02L- LIGHTHOUSE

Berretto LED ricaricabile con catarifrangente  
Rechargeable LED beanie with reflector  
Bonnnet LED rechargeable avec réflecteur  
Gorro con luz LED recargable con reflector  
Wiederaufladbare LED-Kappe mit Reflektor

**NEW**



**DARK GREY**



**WITH REAR REFLECTOR**

CAP02L



COD.									Packing	Inner Pcs	Master Pcs
<b>CAP02L</b>	SMD LED	100 Lm	20 m	2 hrs	Focus light	220 x 200 mm	Lithium polymer 250 mAh (included)	100% Acrylic	Plastic hanger	6	48

## BERRETTI E CAPPELLINI LED RICARICABILI

Rechargeable LED beanies and caps / Bonnets et casquettes LED rechargeables / Gorros y gorras LED recargables / Wiederaufladbare LED-Mützen und -Kappen



RED: BATTERY CHARGING



GREEN: BATTERY FULLY CHARGED



READY FOR USE



EASY ACCESS

Work lighting

### CAP03 - LIGHTHOUSE

Berretto LED ricaricabile  
Rechargeable LED beanie  
Bonnnet LED rechargeable  
Gorro con luz LED recargable  
Mütze mit LED, wiederaufladbar



BLACK

CAP03



COD.									Packing	Inner Pces	Master Pces
<b>CAP03</b>	SMD LED	100 Lm	20 m	2 hrs	Focus light	220 x 200 mm	Lithium polymer 250 mAh (included)	100% Acrylic	Plastic hanger	6	48

### CAP03PILE - LIGHTHOUSE

Berretto LED ricaricabile con fodera in pile  
Rechargeable LED beanie with fleece lining  
Bonnnet LED rechargeable avec doublure polaire  
Gorro con luz LED recargable con forro polar  
Wiederaufladbare LED-Kappe mit Fleecefutter

**NEW**



BLACK



WITH PILE INSIDE

CAP03PILE



COD.									Packing	Inner Pces	Master Pces
<b>CAP03PILE</b>	SMD LED	100 Lm	20 m	2 hrs	Focus light	220 x 200 mm	Lithium polymer 250 mAh (included)	SHELL: 100% Acrylic LINING: 100% Polyester	Plastic hanger	6	48

### CAP04 - LIGHTHOUSE

Berretto LED ricaricabile  
Rechargeable LED beanie  
Bonnnet LED rechargeable  
Gorro con luz LED recargable  
Mütze mit LED, wiederaufladbar



NAVY BLU

CAP04



COD.									Packing	Inner Pces	Master Pces
<b>CAP04</b>	SMD LED	100 Lm	20 m	2 hrs	Focus light	220 x 200 mm	Lithium polymer 250 mAh (included)	100% Acrylic	Plastic hanger	6	48



BERRETTI E CAPPELLINI LED RICARICABILI

Rechargeable LED beanies and caps / Bonnets et casquettes LED rechargeables / Gorros y gorras LED recargables / Wiederaufladbare LED-Mützen und -Kappen

**CAP05 - LIGHTHOUSE**

Berretto LED ricaricabile  
Rechargeable LED beanie  
Bonnnet LED rechargeable  
Gorro con luz LED recargable  
Mütze mit LED, wiederaufladbar



**OLIVE GREEN**

CAP05



COD.									Packing	Inner Pces	Master Pces
<b>CAP05</b>	SMD LED	100 Lm	20 m	2 hrs	Focus light	220 x 200 mm	Lithium polymer 250 mAh (included)	100% Acrylic	Plastic hanger	6	48



**CAP06 - LIGHTHOUSE**

Berretto LED ricaricabile  
Rechargeable LED beanie  
Bonnnet LED rechargeable  
Gorro con luz LED recargable  
Mütze mit LED, wiederaufladbar



**GREEN  
CAMOUFLAGE**

CAP06



COD.									Packing	Inner Pces	Master Pces
<b>CAP06</b>	SMD LED	100 Lm	20 m	2 hrs	Focus light	220 x 200 mm	Lithium polymer 250 mAh (included)	100% Acrylic	Plastic hanger	6	48

## BERRETTI E CAPPELLINI LED RICARICABILI

Rechargeable LED beanies and caps / Bonnets et casquettes LED rechargeables / Gorros y gorras LED recargables / Wiederaufladbare LED-Mützen und -Kappen



Work lighting

### CAP07 - LIGHTHOUSE

Berretto LED ricaricabile  
Rechargeable LED beanie  
Bonnnet LED rechargeable  
Gorro con luz LED recargable  
Mütze mit LED, wiederaufladbar



**YELLOW LIME**

CAP07



COD.									Packing	Inner Pces	Master Pces
<b>CAP07</b>	SMD LED	100 Lm	20 m	2 hrs	Focus light	220 x 200 mm	Lithium polymer 250 mAh (included)	100% Acrylic	Plastic hanger	6	48

### CAP07L - LIGHTHOUSE

Berretto LED ricaricabile con catarifrangente  
Rechargeable LED beanie with reflector  
Bonnnet LED rechargeable avec réflecteur  
Gorro con luz LED recargable con reflector  
Wiederaufladbare LED-Kappe mit Reflektor

**NEW**



**YELLOW LIME**



**WITH REAR REFLECTOR**

CAP07L



COD.									Packing	Inner Pces	Master Pces
<b>CAP07L</b>	SMD LED	100 Lm	20 m	2 hrs	Focus light	220 x 200 mm	Lithium polymer 250 mAh (included)	100% Acrylic	Plastic hanger	6	48

### CAP08 - LIGHTHOUSE

Berretto LED ricaricabile  
Rechargeable LED beanie  
Bonnnet LED rechargeable  
Gorro con luz LED recargable  
Mütze mit LED, wiederaufladbar



**RED**

CAP08



COD.									Packing	Inner Pces	Master Pces
<b>CAP08</b>	SMD LED	100 Lm	20 m	2 hrs	Focus light	220 x 200 mm	Lithium polymer 250 mAh (included)	100% Acrylic	Plastic hanger	6	48

### CAP09 - LIGHTHOUSE

Berretto LED ricaricabile  
Rechargeable LED beanie  
Bonnnet LED rechargeable  
Gorro con luz LED recargable  
Mütze mit LED, wiederaufladbar



**WHITE**

CAP09



COD.									Packing	Inner Pces	Master Pces
<b>CAP09</b>	SMD LED	100 Lm	20 m	2 hrs	Focus light	220 x 200 mm	Lithium polymer 250 mAh (included)	100% Acrylic	Plastic hanger	6	48



### CAP10 - LIGHTHOUSE

Berretto LED ricaricabile  
Rechargeable LED beanie  
Bonnnet LED rechargeable  
Gorro con luz LED recargable  
Mütze mit LED, wiederaufladbar



ORANGE

CAP10



COD.									Packing	Inner Pces	Master Pces
CAP10	SMD LED	100 Lm	20 m	2 hrs	Focus light	220 x 200 mm	Lithium polymer 250 mAh (included)	100% Acrylic	Plastic hanger	6	48

### CAP11 - LIGHTHOUSE

Berretto LED ricaricabile  
Rechargeable LED beanie  
Bonnnet LED rechargeable  
Gorro con luz LED recargable  
Mütze mit LED, wiederaufladbar



PINK

CAP11



COD.									Packing	Inner Pces	Master Pces
CAP11	SMD LED	100 Lm	20 m	2 hrs	Focus light	220 x 200 mm	Lithium polymer 250 mAh (included)	100% Acrylic	Plastic hanger	6	48

### CAP12 - LIGHTHOUSE

Berretto LED ricaricabile  
Rechargeable LED beanie  
Bonnnet LED rechargeable  
Gorro con luz LED recargable  
Mütze mit LED, wiederaufladbar



BLU  
CAMOUFLAGE

CAP12



COD.									Packing	Inner Pces	Master Pces
CAP12	SMD LED	100 Lm	20 m	2 hrs	Focus light	220 x 200 mm	Lithium polymer 250 mAh (included)	100% Acrylic	Plastic hanger	6	48

### CAP14 - LIGHTHOUSE

Berretto LED ricaricabile  
Rechargeable LED beanie  
Bonnnet LED rechargeable  
Gorro con luz LED recargable  
Mütze mit LED, wiederaufladbar



SKY BLU

CAP14



COD.									Packing	Inner Pces	Master Pces
CAP14	SMD LED	100 Lm	20 m	2 hrs	Focus light	220 x 200 mm	Lithium polymer 250 mAh (included)	100% Acrylic	Plastic hanger	6	48

## BERRETTI E CAPPELLINI LED RICARICABILI

Rechargeable LED beanies and caps / Bonnets et casquettes LED rechargeables / Gorros y gorras LED recargables / Wiederaufladbare LED-Mützen und -Kappen



Work lighting

### CAP15 - LIGHTHOUSE

Berretto LED ricaricabile  
Rechargeable LED beanie  
Bonnnet LED rechargeable  
Gorro con luz LED recargable  
Mütze mit LED, wiederaufladbar



**"ROSSONERO"**

CAP15



COD.									Packing	Inner Pces	Master Pces
<b>CAP15</b>	SMD LED	100 Lm	20 m	2 hrs	Focus light	220 x 200 mm	Lithium polymer 250 mAh (included)	100% Acrylic	Plastic hanger	6	48

### CAP16 - LIGHTHOUSE

Berretto LED ricaricabile  
Rechargeable LED beanie  
Bonnnet LED rechargeable  
Gorro con luz LED recargable  
Mütze mit LED, wiederaufladbar



**"NERAZZURRO"**

CAP16



COD.									Packing	Inner Pces	Master Pces
<b>CAP16</b>	SMD LED	100 Lm	20 m	2 hrs	Focus light	220 x 200 mm	Lithium polymer 250 mAh (included)	100% Acrylic	Plastic hanger	6	48

### CAP17 - LIGHTHOUSE

Berretto LED ricaricabile  
Rechargeable LED beanie  
Bonnnet LED rechargeable  
Gorro con luz LED recargable  
Mütze mit LED, wiederaufladbar



**"BIANCONERO"**

CAP17



COD.									Packing	Inner Pces	Master Pces
<b>CAP17</b>	SMD LED	100 Lm	20 m	2 hrs	Focus light	220 x 200 mm	Lithium polymer 250 mAh (included)	100% Acrylic	Plastic hanger	6	48

### CAP18 - LIGHTHOUSE

Berretto LED ricaricabile  
Rechargeable LED beanie  
Bonnnet LED rechargeable  
Gorro con luz LED recargable  
Mütze mit LED, wiederaufladbar



**U.S.A.**

CAP18



COD.									Packing	Inner Pces	Master Pces
<b>CAP18</b>	SMD LED	100 Lm	20 m	2 hrs	Focus light	220 x 200 mm	Lithium polymer 250 mAh (included)	100% Acrylic	Plastic hanger	6	48



### CAP19 - LIGHTHOUSE

Berretto LED ricaricabile  
Rechargeable LED beanie  
Bonnet LED rechargeable  
Gorro con luz LED recargable  
Mütze mit LED, wiederaufladbar



ITALY

CAP19



COD.									Packing	Inner Pces	Master Pces
<b>CAP19</b>	SMD LED	100 Lm	20 m	2 hrs	Focus light	220 x 200 mm	Lithium polymer 250 mAh (included)	100% Acrylic	Plastic hanger	6	48



### CAP23 - ATTLA

Berretto LED ricaricabile  
Rechargeable LED beanie  
Bonnet LED rechargeable  
Gorro con luz LED recargable  
Mütze mit LED, wiederaufladbar



**NEW**

WHITE  
CAMOUFLAGE

CAP23



COD.									Packing	Inner Pces	Master Pces
<b>CAP23</b>	SMD LED	100 Lm	20 m	2 hrs	Focus light	220 x 200 mm	Lithium polymer 250 mAh (included)	SHELL: 95% Polyester +5% Spandex LINING: 100% Polyester	Plastic hanger	6	48

### CAPLED

Luce LED ricaricabile  
Rechargeable LED light  
Lampe LED rechargeable  
Luz LED recargable  
Wiederaufladbares LED-Licht



**NEW**

CAPLED



COD.									Packing	Inner Pces	Master Pces
<b>CAPLED</b>	SMD LED	100 Lm	20 m	2 hrs	Focus light	65 X 45 mm	Lithium polymer 250 mAh (included)	ABS	Polybag	1	500



## BERRETTI E CAPPELLINI LED RICARICABILI

Rechargeable LED beanies and caps / Bonnets et casquettes LED rechargeables / Gorros y gorras LED recargables / Wiederaufladbare LED-Mützen und -Kappen



# MICRO USB RECHARGEABLE!



### CAP83 - STOKER

Berretto LED ricaricabile  
Rechargeable LED beanie  
Bonnnet LED rechargeable  
Gorro con luz LED recargable  
Mütze mit LED, wiederaufladbar



**NEW**

**BLACK**

CAP83



COD.									Packing	Inner Pces	Master Pces
<b>CAP83</b>	4 SMD LED	100 Lm	5 m	6 hrs	Focus light	220 x 200 mm	Lithium polymer 250 mAh (included)	100% Polyester	Plastic hanger	6	48

### CAP85 - STOKER

Berretto LED ricaricabile  
Rechargeable LED beanie  
Bonnnet LED rechargeable  
Gorro con luz LED recargable  
Mütze mit LED, wiederaufladbar



**NEW**

**MILITARY GREEN**

CAP85



COD.									Packing	Inner Pces	Master Pces
<b>CAP85</b>	4 SMD LED	100 Lm	5 m	6 hrs	Focus light	220 x 200 mm	Lithium polymer 250 mAh (included)	100% Polyester	Plastic hanger	6	48

### CAP90 - STOKER

Berretto LED ricaricabile  
Rechargeable LED beanie  
Bonnnet LED rechargeable  
Gorro con luz LED recargable  
Mütze mit LED, wiederaufladbar



**NEW**

**ORANGE**

CAP90



COD.									Packing	Inner Pces	Master Pces
<b>CAP90</b>	4 SMD LED	100 Lm	5 m	6 hrs	Focus light	220 x 200 mm	Lithium polymer 250 mAh (included)	100% Polyester	Plastic hanger	6	48



Work lighting

**MICRO USB RECHARGEABLE!**



**CAP103 - BATCAP**

Cappellino LED ricaricabile  
Rechargeable LED cap  
Bonnet LED rechargeable  
Gorra con luz LED recargable  
Mütze mit LED, wiederaufladbar



**BLACK**

CAP103



COD.									Packing	Inner Pcs	Master Pcs
<b>CAP103</b>	4 SMD LED	100 Lm	5 m	6 hrs	Focus light	220 x 200 mm	Lithium polymer 250 mAh (included)	100% Cotton	Plastic hanger	6	48

**CAP104 - BATCAP**

Cappellino LED ricaricabile  
Rechargeable LED cap  
Bonnet LED rechargeable  
Gorra con luz LED recargable  
Mütze mit LED, wiederaufladbar



**NAVY BLUE**

CAP104



COD.									Packing	Inner Pcs	Master Pcs
<b>CAP104</b>	4 SMD LED	100 Lm	5 m	6 hrs	Focus light	220 x 200 mm	Lithium polymer 250 mAh (included)	100% Cotton	Plastic hanger	6	48

**CAP106 - BATCAP**

Cappellino LED ricaricabile  
Rechargeable LED cap  
Bonnet LED rechargeable  
Gorra con luz LED recargable  
Mütze mit LED, wiederaufladbar



**CAMOUFLAGE**

CAP106



COD.									Packing	Inner Pcs	Master Pcs
<b>CAP106</b>	4 SMD LED	100 Lm	5 m	6 hrs	Focus light	220 x 200 mm	Lithium polymer 250 mAh (included)	100% Cotton	Plastic hanger	6	48



# Outdoor lighting

# PLAFONIERE LED INTEGRATI ECOPOWER

120  
Lm/W

LED

Outdoor lighting



ECOPOWER218



ECOPOWER236



ECOPOWER258



CRI &gt; 80



&gt;30.000 hrs



Not Dimmable



Protection class



Insulation class



INTER CONNECTION



Codice Prodotto Item code Code Codigo Code	Alimentazione Power source Alimentation Alimentación Stromversorgung	Tecnologia della Luce Light technology Technologie de la lumière Tecnología de iluminación Beleuchtungstechnologie	Potenza (W) Watt power Puissance Potencia Leistung	Lumen Lumen Lumen Lumen	Tipo di luce Kelvin degrees Degrés Kelvin Temperatura de luz °K	Apertura Fascio Kind of beam Type de faisceau Tipo de haz Ausstrahlungswinkel	Materiale Material Materiau Material Material	Collegamenti Connections Connexions Conexiones Anschlüsse
ECOPOWER218	220-240V ~ 50/60 Hz	66 LED SMD 2835	21W	2500 Lm	4000K	120°-150°	PC	max 21 pcs
ECOPOWER236	220-240V ~ 50/60 Hz	126 LED SMD 2835	40W	4800 Lm	4000K	120°-150°	PC	max 11 pcs
ECOPOWER258	220-240V ~ 50/60 Hz	168 LED SMD 2835	55W	6600 Lm	4000K	120°-150°	PC	max 7 pcs

Descrizione / Description / Description / Descripción / Beschreibung:

Plafoniera LED per esterno  
Waterproof LED light fitting  
Réglette IP65 LED  
Plafon LED de techo para exterior  
LED-Deckenleuchte für Außenbereiche

Driver incluso  
Driver Included  
Driver fourni  
Driver incluido  
Driver inbegriffen

Accessori inclusi / Accessories included / Accessoires fournis / Accesorios incluidos / Mitgeliefertes Zubehör:



Kit di installazione  
Installation kit  
2 clips + 2 screws + 2 dowels

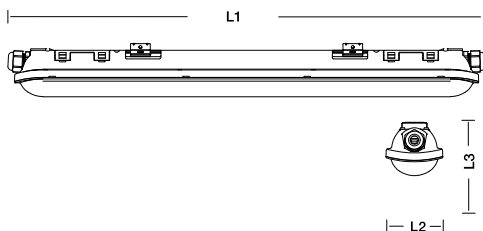

Codice Prodotto Item code Code Codigo Code	Lunghezza L1 Length Longueur Lungitud Länge	Larghezza L2 Width Largeur Ancho Breite	Altezza L3 Height Hauteur Altura Höhe	Imballo Packaging Emballage Embalaje Verpackung	Inner Pcs	Master Pcs
ECOPOWER218	590	72	61	Colour box	-	12
ECOPOWER236	1180	72	61	Colour box	-	12
ECOPOWER258	1480	72	61	Colour box	-	12

ECOPOWER218



ECOPOWER236



ECOPOWER258



# PLAFONIERE LED INTEGRATI STARLED



**110**  
Lm/W

**LED**



STARLED218



STARLED236



STARLED258



CRI > 80



20.000 hrs



Not Dimmable



Protection  
lass



Insulation  
class



Codice Prodotto Item code Code Codigo Code	Alimentazione Power source Alimentation Alimentación Stromversorgung	Tecnologia della Luce Light technology Technologie de la lumière de iluminación Beleuchtungstechnologie	Potenza (W) Watt power Puissance Potencia Leistung	Lumen Lumen Lumen Lumen	Tipo di luce Kelvin degrees Degrés Kelvin Temperatura de luz °K	Apertura Fascio Kind of beam Type de faisceau Tipo de haz Ausstrahlungswinkel	Materiale Material Materiau Material Material
STARLED218	220-240V ~ 50/60 Hz	120 LED SMD 2835	25W	3000 Lm	4000K	120°	PC
STARLED236	220-240V ~ 50/60 Hz	204 LED SMD 2835	45W	5000 Lm	4000K	120°	PC
STARLED258	220-240V ~ 50/60 Hz	240 LED SMD 2835	55W	6000 Lm	4000K	120°	PC

Descrizione / Description / Description / Descripción / Beschreibung:

Accessori inclusi / Accessories included / Accessoires fournis / Accesorios incluidos / Mitgeliefertes Zubehör:

Plafoniera LED per esterno  
Waterproof LED light fitting  
Réglette IP65 LED  
Plafon LED de techo para exterior  
LED-Deckenleuchte für Außenbereiche

Driver incluso  
Driver Included  
Driver fourni  
Driver incluido  
Driver inbegriffen

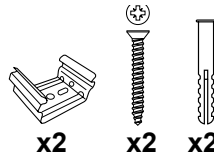

x2 x2 x2

Kit di installazione  
Installation kit  
2 clips + 2 screws + 2 dowels



Pressacavo ad attacco rapido  
Fast cable gland

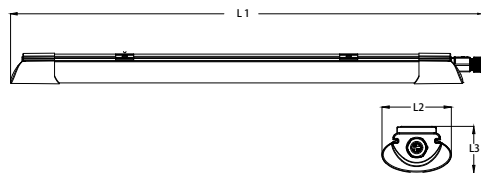

Codice Prodotto Item code Code Codigo Code	Lunghezza L1 Length Longueur Lungitud Länge	Larghezza L2 Width Largeur Ancho Breite	Altezza L3 Height Hauteur Altura Höhe	Imballo Packing Emballage Embalaje Verpackung	Inner Pces	Master Pces
STARLED218	650 mm	74 mm	42,5 mm	Colour box	-	15
STARLED236	1250 mm	74 mm	42,5 mm	Colour box	-	15
STARLED258	1550 mm	74 mm	42,5 mm	Colour box	-	15

STARLED218



STARLED236



STARLED258





# PLAFONIERE CON UN TUBO LED



100  
Lm/W

TUBI LED  
INCLUSI  
LED TUBES  
INCLUDED



Protection  
class



Containing  
product



Base



Diffuser



Clips



TNE SERIES



Codice Prod. Item code Code Codigo Code	Alimentazione Power source Alimentation Alimentación Stromversorgung	Tecnologia della Luce Light technology Technologie de la lumière Tecnología de iluminación Beleuchtungstechnologie	Formato Format Formato Formato Format	Attacco Lamp holder Culot Ataco Halterung	Potenza (W) Watt power Puissance Potencia Leistung	Lumen Lumen Lumen Lumen Lumen	Tipo di luce Kelvin degrees Degrés Kelvin Temperatura de luz °K	Apertura Fascio Kind of beam Type de faisceau Tipo de haz Ausstrahlungswinkel	Materiale Material Materiau Material Material
TNE118	220V-240V ~ 50 Hz	1 LED tube 60 cm (included)	T8	G13	9W	900 Lm	4000K	Tube: 300°, Fixture: 120°	Tube: Glass
TNE136	220V-240V ~ 50 Hz	1 LED tube 120 cm (included)	T8	G13	18W	1800 Lm	4000K	Tube: 300°, Fixture: 120°	Tube: Glass
TNE158	220V-240V ~ 50 Hz	1 LED tube 150 cm (included)	T8	G13	22W	2200 Lm	4000K	Tube: 300°, Fixture: 120°	Tube: Glass

Descrizione / Description / Description / Descripción / Beschreibung:

Plafoniera per esterno con 1 tubo LED  
 Waterproof light fitting with 1 LED tube  
 Réglette IP65 avec 1 tube LED  
 Regleta estanca con 1 tubo LED  
 Deckenleuchte für Außenbereiche mit 1 LED-Röhren

Accessori inclusi / Accessories included / Accessoires fournis / Accesorios incluidos / Mitgeliefertes Zubehör:

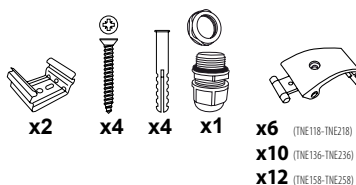

Kit di installazione  
Installation kit

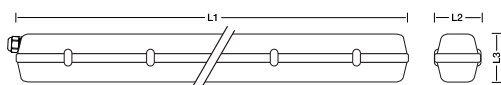

TNE118



TNE136



TNE158



Codice Prodotto Item code Code Codigo Code	Lunghezza L1 Length Longueur Longitud Länge	Larghezza L2 Width Largeur Ancho Breite	Altezza L3 Height Hauteur Altura Hohe	Imballo Packing Emballage Embalaje Verpackung	Inner Pces	Master Pces
TNE118	665 mm	60 mm	62 mm	Colour box	-	12
TNE136	1275 mm	60 mm	62 mm	Colour box	-	12
TNE158	1575 mm	60 mm	62 mm	Colour box	-	12

# PLAFONIERE CON DUE TUBI LED



100  
Lm/W

TUBI LED  
INCLUSI!  
LED TUBES  
INCLUDED

Outdoor lighting



Protection class



Containing product



Base



Diffuser



Clips



TNE SERIES



Codice Prod. Item code Code Codigo Code	Alimentazione Power source Alimentation Alimentación Stromversorgung	Tecnologia della Luce Light technology Technologie de la lumière Tecnología de iluminación Beleuchtungstechnologie	Formato Format Formato Formato Format	Attacco Lamp holder Culot Ataco Halterung	Potenza (W) Watt power Puissance Potencia Leistung	Lumen Lumen Lumen Lumen Lumen	Tipo di luce Kelvin degrees Degrés Kelvin Temperatura de luz °K	Apertura Fascio Kind of beam Type de faisceau Tipo de haz Ausstrahlungswinkel	Materiale Material Materiau Material Material
<b>TNE218</b>	220V-240V ~ 50 Hz	2 LED tubes 60 cm (included)	T8	G13	2 x 9W	1800 Lm	4000K	Tube: 300°, Fixture: 120°	Tube: Glass
<b>TNE236</b>	220V-240V ~ 50 Hz	2 LED tubes 120 cm (included)	T8	G13	2 x 18W	3600 Lm	4000K	Tube: 300°, Fixture: 120°	Tube: Glass
<b>TNE258</b>	220V-240V ~ 50 Hz	2 LED tubes 150 cm (included)	T8	G13	2 x 22W	4400 Lm	4000K	Tube: 300°, Fixture: 120°	Tube: Glass

**Descrizione / Description / Description / Descripción / Beschreibung:**

Plafoniera per esterno con 2 tubi LED  
Waterproof light fitting with 2 LED tubes  
Réglette IP65 avec 2 tubes LED  
Regleta estanca con 2 tubos Led  
Deckenleuchte für Außenbereiche mit 2 LED-Röhren

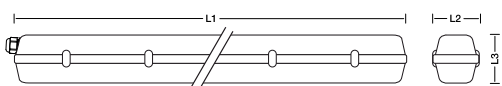

**Accessori inclusi / Accessories included / Accessoires fournis / Accesorios incluidos / Mitgeliefertes Zubehör:**

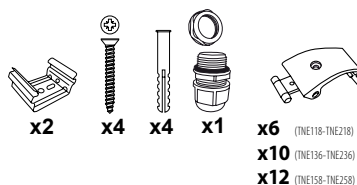

**Kit di installazione**  
Installation kit

**TNE218**



**TNE236**



**TNE258**



Codice Prodotto Item code Code Codigo Code	Lunghezza L1 Length Longueur Lungitud Länge	Larghezza L2 Width Largeur Ancho Breite	Altezza L3 Height Hauteur Altura Höhe	Imballo Packing Emballage Embalaje Verpackung	Inner Pces	Master Pces
<b>TNE218</b>	665 mm	110 mm	62 mm	Colour box	-	8
<b>TNE236</b>	1275 mm	110 mm	62 mm	Colour box	-	8
<b>TNE258</b>	1575 mm	110 mm	62 mm	Colour box	-	8

# PLAFONIERE PER TUBI LED

ONLY FOR  
LED TUBES

Outdoor lighting

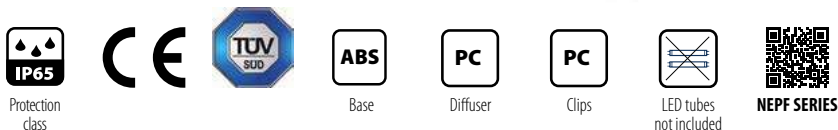

Codice Prod. Item code Code Codigo Code	Alimentazione Power source Alimentation Alimentación Stromversorgung	Tecnologia della Luce Light technology Technologie de la lumière Tecnología de iluminación Beleuchtungstechnologie	Formato Format Formato Formato Format	Attacco Lamp holder Culot Ataco Halterung	Materiale Material Materiau Material Material	Lunghezza L1 Length Longueur Lungitud Länge	Larghezza L2 Width Largeur Ancho Breite	Altezza L3 Height Hauteur Altura Höhe	Imballo Packing Emballage Embalaje Verpackung	Inner Pces	Master Pces
NEPF118	220V-240V ~ 50 Hz	1 LED tube 60 cm (not included)	T8	G13	ABS+PC	665 mm	60 mm	62 mm	Colour box	-	12
NEPF218	220V-240V ~ 50 Hz	2 LED tubes 60 cm (not included)	T8	G13	ABS+PC	665 mm	110 mm	62 mm	Colour box	-	8
NEPF136	220V-240V ~ 50 Hz	1 LED tube 120 cm (not included)	T8	G13	ABS+PC	1275 mm	60 mm	62 mm	Colour box	-	12
NEPF236	220V-240V ~ 50 Hz	2 LED tubes 120 cm (not included)	T8	G13	ABS+PC	1275 mm	110 mm	62 mm	Colour box	-	8
NEPF158	220V-240V ~ 50 Hz	1 LED tube 150 cm (not included)	T8	G13	ABS+PC	1575 mm	60 mm	62 mm	Colour box	-	12
NEPF258	220V-240V ~ 50 Hz	2 LED tubes 150 cm (not included)	T8	G13	ABS+PC	1575 mm	110 mm	62 mm	Colour box	-	8

Descrizione / Description / Description / Descripción / Beschreibung:

Accessori inclusi / Accessories included / Accessoires fournis / Accesorios incluidos / Mitgeliefertes Zubehör:

Plafoniera per esterno da usare esclusivamente con 2 tubi LED

Prodotto senza alimentazione

Waterproof light fitting compatible with 2 LED tube

Item without power supply

Réglette IP65 compatible exclusivement avec 2 tubes LED

Produit sans alimentation

Regleta estanca que funciona exclusivamente con 2 tubos LED

Productos sin fuentes de alimentación

Deckenleuchte für Außenbereiche ausschließlich für LED-Röhren

Produkt ohne Stromversorgung

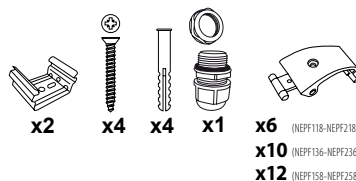

Kit di installazione  
Installation kit

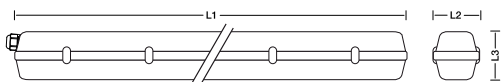

NEPF118



NEPF136



NEPF158



NEPF218



NEPF236



NEPF258





# TUBI LED T8



Outdoor lighting



TBLED SERIES

Codice Prodotto Item code Code Codigo Code	Alimentazione Power source Alimentation Alimentación Stromversorgung	Tecnologia della Luce Light technology Technologie de la lumière Tecnología de iluminación Beleuchtungstechnologie	Formato Format Formato Formato Format	Attacco Lamp holder Culot Ataco Halterung	Potenza (W) Watt power Puissance Potencia Leistung	Lumen Lumen Lumen Lumen	Tipo di luce Kelvin degrees Kelvin Degrés Kelvin Temperatura de luz °K	Apertura Fascio Kind of beam Type de faisceau Tipo de haz Ausstrahlungswinkel	Materiale Material Materiu Material Material
<b>TBLED9W-4000K</b>	220-240V ~ 50/60 Hz	LED SMD 2835	T8	G13	9W	1000 Lm	4000K	300°	Glass
<b>TBLED9W-6500K</b>	220-240V ~ 50/60 Hz	LED SMD 2835	T8	G13	9W	1000 Lm	6500K	300°	Glass
<b>TBLED18W-4000K</b>	220-240V ~ 50/60 Hz	LED SMD 2835	T8	G13	18W	2000 Lm	4000K	300°	Glass
<b>TBLED18W-6500K</b>	220-240V ~ 50/60 Hz	LED SMD 2835	T8	G13	18W	2000 Lm	6500K	300°	Glass
<b>TBLED22W-4000K</b>	220-240V ~ 50/60 Hz	LED SMD 2835	T8	G13	24W	2600 Lm	4000K	300°	Glass
<b>TBLED22W-6500K</b>	220-240V ~ 50/60 Hz	LED SMD 2835	T8	G13	24W	2600 Lm	6500K	300°	Glass

Descrizione / Description / Description / Descripción / Beschreibung:

Accessori inclusi / Accessories included / Accessoires fournis / Accesorios incluidos / Mitgeliefertes Zubehör:

Tubo LED  
Tube LED  
Tube LED  
Tubo LED  
LED-Röhre

Driver incluso, Driver Included, Driver fourni, Driver incluido, Driver inbegriffen

Codice Prodotto Item code Code Codigo Code	Lunghezza L1 Length Longueur Lungitud Länge	Larghezza L2 Width Largeur Ancho Breite	Altezza L3 Height Hauteur Altura Höhe	Imballo Packing Emballage Embalaje Verpackung	Inner Pces	Master Pces
<b>TBLED9W-4000K</b>	590 mm	26 mm	26 mm	White box	-	25
<b>TBLED9W-6500K</b>	590 mm	26 mm	26 mm	White box	-	25
<b>TBLED18W-4000K</b>	1199 mm	26 mm	26 mm	White box	-	25
<b>TBLED18W-6500K</b>	1199 mm	26 mm	26 mm	White box	-	25
<b>TBLED22W-4000K</b>	1499 mm	26 mm	26 mm	White box	-	25
<b>TBLED22W-6500K</b>	1499 mm	26 mm	26 mm	White box	-	25

**TBLED9W-4000K**



**TBLED18W-4000K**



**TBLED22W-4000K**



**TBLED9W-6500K**



**TBLED18W-6500K**



**TBLED22W-6500K**





# UBLO2

Outdoor lighting



UBLO-2



CRI > 80



25,000 hrs



Not Dimmable



Protection class



Insulation class



Containing product



Codice Prodotto Item code Code Codigo Code	Alimentazione Power source Alimentation Alimentación Stromversorgung	Tecnologia della Luce Light technology Technologie de la lumière Tecnología de iluminación Beleuchtungstechnologie	Potenza (W) Watt power Puissance Potencia Leistung	Lumen Lumen Lumen Lumen	Tipo di luce Kelvin degrees Degrés Kelvin Temperatura de luz °K	Apertura Fascio Kind of beam Type de faisceau Tipo de haz Ausstrahlungswinkel	Materiale Material Materiau Material Material
UBLO2	220-240V ~ 50 Hz	LED SMD 2835	10W	700 Lm	4000K	Diffuse 120°	PP body + PC diffuser + ABS frame

**Descrizione** / Description / Description / Descripción / Beschreibung:

Plafoniera LED tonda  
LED round ceiling lamp  
Applique LED ronde  
Applique LED redondo  
Runde LED-Wandleuchte

Driver incluso  
Driver Included  
Driver fourni  
Driver incluido  
Driver inbegriffen

**Accessori inclusi** / Accessories included / Accessoires fournis / Accesorios incluidos / Mitgeliefertes Zubehör:



**Kit di installazione**  
Installation kit



**2 covers forniti**  
2 covers included

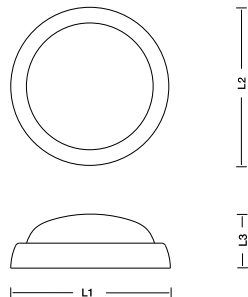

Codice Prodotto Item code Code Codigo Code	Lunghezza L1 Length Longueur Longitud Länge	Larghezza L2 Width Largeur Ancho Breite	Altezza L3 Height Hauteur Altura Höhe	Imballo Packing Emballage Embalaje Verpackung	Inner Pces	Master Pces
UBLO2	160 mm	160 mm	70 mm	Colour box	6	48

UBLO2



# PLAFONIERE LED TONDE

LED ceiling lamps / Plafonniers à LED intégrés / Plafon LED / LED-Deckenlampe



## UBLO-XIR



UBLO-XIR



CRI > 80



25.000 hrs



Not Dimmable



Protection class



Insulation class



Containing product



Codice Prodotto Item code Code Codigo Code	Alimentazione Power source Alimentation Alimentación Stromversorgung	Tecnologia della Luce Light technology Technologie de la lumière Tecnología de iluminación Beleuchtungstechnologie	Potenza (W) Watt power Puissance Potencia Leistung	Lumen Lumen Lumen Lumen Lumen	Tipo di luce Kelvin degrees Degrés Kelvin Temperatura de luz °K	Apertura Fascio Kind of beam Type de faisceau Tipo de haz Ausstrahlungswinkel	Materiale Material Materiau Material Material
UBLO-XIR	220-240V ~ 50 Hz	LED SMD 2835 0,2W	12W	840 Lm	4000K	Diffuse 120°	PC diffuser + ABS frame

### Descrizione / Description / Description / Descripción / Beschreibung:

Plafoniera LED tonda con rilevatore di movimento  
LED round ceiling lamp with IR motion sensor  
Applique LED ronde avec détecteur de mouvement  
Applique LED redondo con detector de movimiento  
Runde LED-Wandleuchte mit IR Bewegungsmelder

Driver incluso  
Driver included  
Driver fourni  
Driver incluido  
Driver inbegriffen

### Accessori inclusi / Accessories included / Accessoires fournis / Accesorios incluidos / Mitgeliefertes Zubehör:



Kit di installazione  
Installation kit



Facilità di connessione  
Easy connect

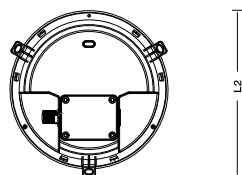

3

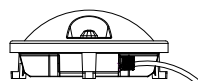

3  
1

Codice Prodotto Item code Code Codigo Code	Lunghezza L1 Length Longueur Longitud Länge	Larghezza L2 Width Largeur Ancho Breite	Altezza L3 Height Hauteur Altura Höhe	Imballo Packing Emballage Embalaje Verpackung	Inner Pces	Master Pces
UBLO-XIR	197 mm	197 mm	82 mm	Colour box	6	24

UBLO-XIR





# UBLO-XXL2



UBLO-XXL2



CRI > 80



25,000 hrs



Not Dimmable



Protection class



Insulation class



Containing product



Codice Prodotto Item code Code Codigo Code	Alimentazione Power source Alimentation Alimentación Stromversorgung	Tecnologia della Luce Light technology Technologie de la lumière Tecnología de iluminación Beleuchtungstechnologie	Potenza (W) Watt power Puissance Potencia Leistung	Lumen Lumen Lumen Lumen	Tipo di luce Kelvin degrees Degrés Kelvin Temperatura de luz °K	Apertura Fascio Kind of beam Type de faisceau Tipo de haz Ausstrahlungswinkel	Materiale Material Materiau Material Material
<b>UBLO-XXL2</b>	220-240V ~ 50 Hz	LED SMD 2835	20W	1600 Lm	4000K	Diffuse 120°	PP body + PC diffuser

**Descrizione / Description / Description / Descripción / Beschreibung:**

Plafoniera LED tonda  
LED round ceiling lamp  
Applique LED ronde  
Applique LED redondo  
Runde LED-Wandleuchte

Driver incluso  
Driver included  
Driver fourni  
Driver incluido  
Driver inbegriffen

**Accessori inclusi / Accessories included / Accessoires fournis / Accesorios incluidos / Mitgeliefertes Zubehör:**



**Kit di installazione**  
Installation kit



**EASY CONNECT** ✓  
**WATER RESISTANT** ✓



**Installazione veloce**  
Easy installation

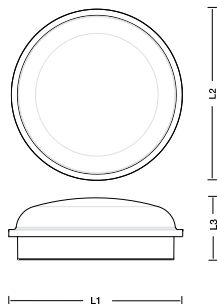

Codice Prodotto Item code Code Codigo Code	Lunghezza L1 Length Longueur Lungitud Länge	Larghezza L2 Width Largeur Ancho Breite	Altezza L3 Height Hauteur Altura Höhe	Imballo Packing Emballage Embalaje Verpackung	Inner Pces	Master Pces
<b>UBLO-XXL2</b>	220 mm	220 mm	81 mm	Colour box	6	24

UBLO-XXL2



# PTLEDIK-E27



Outdoor

**ANTI  
VANDALISM**

PTLEDIK-E27



Protection class



Insulation class



Mechanical resistance



Codice Prodotto Item code Code Codigo Code	Alimentazione Power source Alimentation Alimentación Stromversorgung	Tecnologia della Luce Light technology Technologie de la lumière Tecnología de iluminación Beleuchtungstechnologie	Potenza (W) Watt power Puissance Potencia Leistung	Apertura Fascio Kind of beam Type de faisceau Tipo de haz Ausstrahlungswinkel	Materiale Material Materiau Material Material
PTLEDIK-E27	220-240V ~ 50/60 Hz	E27 Lamp holder	Max 60W	120°	PC

**Descrizione / Description / Description / Descripción / Beschreibung:**

Plafoniera tonda IP54 con diffusore in PC  
 IP54 LED ceiling lamp with PC diffuser and structure  
 Plafonnier à LED intégrées IP54, structure et diffuseur en PC  
 Plafon Led redondo en PC + difusor  
 LED-Deckenlampe: Körper und Diffusor aus PC

**Accessori inclusi / Accessories included / Accessoires fournis / Accesorios incluidos / Mitgeliefertes Zubehör:**



**Kit di installazione**  
Installation kit

Codice Prodotto Item code Code Codigo Code	Diametro D1 Diameter Diamètre Diámetro Breite	Altezza L1 Height Hauteur Altura Höhe	Imballo Packing Emballage Embalaje Verpackung	Inner Pces	Master Pces
PTLEDIK-E27	270 mm	95 mm	Colour box	-	12

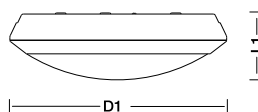

PTLEDIK-E27





## BIGBOB



BIGBOB-B



Protection class



Insulation class



intertek

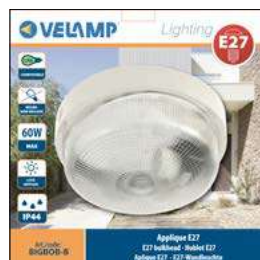

Codice Prodotto Item code Code Codigo Code	Alimentazione Power source Alimentation Alimentación Stromversorgung	Tecnologia della Luce Light technology Technologie de la lumière Tecnología de iluminación Beleuchtungstechnologie	Potenza (W) Watt power Puissance Potencia Leistung	Apertura Fascio Kind of beam Type de faisceau Tipo de haz Ausstrahlungswinkel	Materiale Material Materiau Material Material
<b>BIGBOB-B</b>	220-240V ~ 50/60 Hz	E27 Lamp holder	Max 60W	120°	Glass+Plastic

Descrizione / Description / Description / Descripción / Beschreibung:

Accessori inclusi / Accessories included / Accessoires fournis / Accesorios incluidos / Mitgeliefertes Zubehör:

Applique E27  
E27 bulkhead  
Hublot E27  
Aplique E27  
E27-Wandleuchte



**Kit di installazione**  
Installation kit

Codice Prodotto Item code Code Codigo Code	Diametro D1 Diameter Diamètre Diámetro Breite	Altezza L1 Height Hauteur Altura Höhe	Imballo Packing Emballage Embalaje Verpackung	Inner Pces	Master Pces
<b>BIGBOB-B</b>	221 mm	101 mm	Colour box	-	8

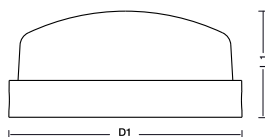

BIGBOB-B



# PLAFONIERE TONDE

Ceiling lamps / Plafonniers / Plafon / Deckenlampe



## BUBBLE



BUBBLE-B



BUBBLE-N



Protection class



Insulation class



intertek

Codice Prodotto Item code Code Codigo Code	Alimentazione Power source Alimentation Alimentación Stromversorgung	Tecnologia della Luce Light technology Technologie de la lumière Tecnología de iluminación Beleuchtungstechnologie	Potenza (W) Watt power Puissance Potencia Leistung	Apertura Fascio Kind of beam Type de faisceau Tipo de haz Ausstrahlungswinkel	Materiale Material Materiau Material Material
<b>BUBBLE-B</b>	220V-240V ~ 50/60 Hz	E27 Lamp holder	max 60W	Diffuse	Glass + Plastic
<b>BUBBLE-N</b>	220V-240V ~ 50/60 Hz	E27 Lamp holder	max 60W	Diffuse	Glass + Plastic

Descrizione / Description / Description / Descripción / Beschreibung:

Accessori inclusi / Accessories included / Accessoires fournis / Accesorios incluidos / Mitgeliefertes Zubehör:

Applique E27  
E27 bulkhead  
Hublot E27  
Aplicigo E27  
E27-Wandleuchte

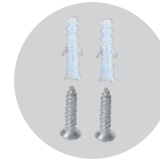

Kit di installazione  
Installation kit

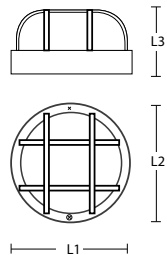

Codice Prodotto Item code Code Codigo Code	Lunghezza L1 Length Longueur Lungitud Länge	Larghezza L2 Width Largeur Ancho Breite	Altezza L3 Height Hauteur Altura Höhe	Imballo Packing Emballage Embalaje Verpackung	Inner Pces	Master Pces
<b>BUBBLE-B</b>	188 mm	188 mm	96 mm	Shrink	12	24
<b>BUBBLE-N</b>	188 mm	188 mm	96 mm	Shrink	12	24

BUBBLE-B



BUBBLE-N





# TARTARUGA



TARTARUGA-N



TARTARUGA-B



CRI > 80



30,000 hrs



Not Dimmable



Protection class



Insulation class



Containing product



Codice Prodotto Item code Code Codigo Code	Alimentazione Power source Alimentation Alimentación Stromversorgung	Tecnologia della Luce Light technology Technologie de la lumière Tecnología de iluminación Beleuchtungstechnologie	Potenza (W) Watt power Puissance Potencia Leistung	Lumen Lumen Lumen Lumen Lumen	Tipo di luce Kelvin degrees Degrés Kelvin Temperatura de luz °K	Apertura Fascio Kind of beam Type de faisceau Tipo de haz Ausstrahlungswinkel	Materiale Material Materiau Material Material
TARTARUGA-N	110V-240V ~ 50/60 Hz	LED SMD 2835	6W	450 Lm	4000K	Diffuse	PP
TARTARUGA-B	110V-240V ~ 50/60 Hz	LED SMD 2835	6W	450 Lm	4000K	Diffuse	PP

Descrizione / Description / Description / Descripción / Beschreibung:

Applique LED  
LED bulkheads  
Hublots LED  
Aplique LED  
LED-Wandleuchte

Driver incluso  
Driver Included  
Driver fourni  
Driver incluido  
Driver inbegriffen

Accessori inclusi / Accessories included / Accessoires fournis / Accesorios incluidos / Mitgeliefertes Zubehör:



Perfetta per installazione con canalina  
Perfect for installation with electrical conduit pipes



Kit di installazione  
Installation kit

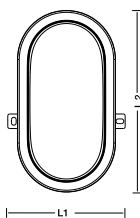
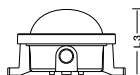

Codice prodotto Item code Code Codigo Code	Larghezza L1 Width Largeur Ancho Breite	Lunghezza L2 Length Longueur Lungitud Länge	Altezza L3 Height Hauteur Altura Höhe	Imballo Packing Emballage Embalaje Verpackung	Inner Pcs	Master Pcs
TARTARUGA-N	125 mm	65 mm	175 mm	Shrink	12	48
TARTARUGA-B	125 mm	65 mm	175 mm	Shrink	12	48

TARTARUGA-N



TARTARUGA-B





# APPLIQUE DA ESTERNO

LED bulkheads / Hublots LED / Aplique Led / LED-Wandleuchten



## PALPEBRA



PALPEBRA-B



PALPEBRA-N



CRI > 80



25,000 hrs



Not Dimmable



Protection class



Insulation class



Energy class



Codice Prodotto Item code Code Codigo Code	Alimentazione Power source Alimentation Alimentación Stromversorgung	Tecnologia della Luce Light technology Technologie de la lumière Tecnología de iluminación Beleuchtungstechnologie	Potenza (W) Watt power Puissance Potencia Leistung	Lumen Lumen Lumen Lumen Lumen	Tipo di luce Kelvin degrees Degrés Kelvin Temperatura de luz °K	Apertura Fascio Kind of beam Type de faisceau Tipo de haz Ausstrahlungswinkel	Materiale Material Materiau Material Material
PALPEBRA-B	220V-240V ~ 50/60 Hz	LED SMD 2835	6W	450 Lm	4000K	Diffuse	PP
PALPEBRA-N	220V-240V ~ 50/60 Hz	LED SMD 2835	6W	450 Lm	4000K	Diffuse	PP

Descrizione / Description / Description / Descripción / Beschreibung:

Applique LED  
LED bulkheads  
Hublots LED  
Aplique LED  
LED-Wandleuchte

Driver incluso  
Driver Included  
Driver fourni  
Driver incluido  
Driver inbegriffen

Accessori inclusi / Accessories included / Accessoires fournis / Accesorios incluidos / Mitgeliefertes Zubehör:



Perfetta per installazione con canalina  
Perfect for installation with electrical conduit pipes

Kit di installazione  
Installation kit

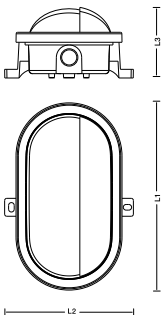

Codice Prodotto Item code Code Codigo Code	Lunghezza L1 Length Longueur Lungitud Länge	Larghezza L2 Width Largeur Ancho Breite	Altezza L3 Height Hauteur Altura Höhe	Imballo Packing Emballage Embalaje Verpackung	Inner Pces	Master Pces
PALPEBRA-B	175 mm	125 mm	65 mm	Shrink	12	48
PALPEBRA-N	175 mm	125 mm	65 mm	Shrink	12	48

PALPEBRA-B



PALPEBRA-N





# TARTARUGA-XL2



Outdoor lighting



TARTARUGA-XL2



CRI > 80



30.000 hrs



Not Dimmable



Protection class



Insulation class



Containing product



Codice Prodotto Item code Code Codigo Code	Alimentazione Power source Alimentation Alimentación Stromversorgung	Tecnologia della Luce Light technology Technologie de la lumière Tecnología de iluminación Beleuchtungstechnologie	Potenza (W) Watt power Puissance Potencia Leistung	Lumen Lumen Lumen Lumen	Tipo di luce Kelvin degrees Degrés Kelvin Temperatura de luz °K	Apertura Fascio Kind of beam Type de faisceau Tipo de haz Ausstrahlungswinkel	Materiale Material Materiau Material Material
TARTARUGA-XL2	220V-240V ~ 50 Hz	LED SMD 2835	14W	1000 Lm	4000K	Diffuse 120°	PC body + PC diffuser + ABS frame

**Descrizione** / Description / Description / Descripción / Beschreibung:

Applique LED  
LED bulkheads  
Hublots LED  
Applique LED  
LED-Wandleuchte

Driver incluso  
Driver Included  
Driver fourni  
Driver incluido  
Driver inbegriffen

**Accessori inclusi** / Accessories included / Accessoires fournis / Accesorios incluidos / Mitgeliefertes Zubehör:



**Kit di installazione**  
Installation kit



**2 covers forniti**  
2 covers included

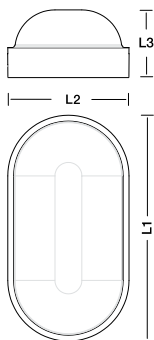

Codice prodotto Item code Code Codigo Code	Larghezza L1 Width Largeur Ancho Breite	Lunghezza L2 Length Longueur Lungitud Länge	Altezza L3 Height Hauteur Altura Höhe	Imballo Packing Emballage Embalaje Verpackung	Inner Pces	Master Pces
TARTARUGA-XL2	212 mm	119 mm	60.5 mm	Colour box	6	24

TARTARUGA-XL2



# APPLIQUE DA ESTERNO

LED bulkheads / Hublots LED / Applique Led / LED-Wandleuchten

## TARTARUGA-XXL2



TARTARUGA-XXL2



Outdoor lighting



CRI > 80



30.000 hrs



Not Dimmable



Protection class



Insulation class



Containing product



Codice Prodotto Item code Code Codigo Code	Alimentazione Power source Alimentation Alimentación Stromversorgung	Tecnologia della Luce Light technology Technologie de la lumière Tecnología de iluminación Beleuchtungstechnologie	Potenza (W) Watt power Puissance Potencia Leistung	Lumen Lumen Lumen Lumen Lumen	Tipo di luce Kelvin degrees Degrés Kelvin Temperatura de luz °K	Apertura Fascio Kind of beam Type de faisceau Tipo de haz Ausstrahlungswinkel	Materiale Material Materiau Material Material
<b>TARTARUGA-XXL2</b>	220V-240V ~ 50 Hz	LED SMD 2835	20W	1600 Lm	4000K	Diffuse 120°	PP body + PC diffuser

Descrizione / Description / Descripción / Beschreibung:

Applique LED  
LED bulkheads  
Hublots LED  
Applique LED  
LED-Wandleuchte

Driver incluso  
Driver Included  
Driver fournis  
Driver incluido  
Driver inbegriffen

Accessori inclusi / Accessories included / Accessoires fournis / Accesorios incluidos / Mitgeliefertes Zubehör:



Kit di installazione  
Installation kit



Installazione veloce  
Easy installation

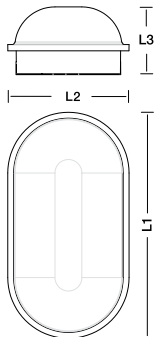

Codice prodotto Item code Code Codigo Code	Larghezza L1 Width Largeur Ancho Breite	Lunghezza L2 Length Longueur Lungitud Länge	Altezza L3 Height Hauteur Altura Höhe	Imballo Packing Emballage Embalaje Verpackung	Inner Pces	Master Pces
<b>TARTARUGA-XXL2</b>	270 mm	145 mm	81 mm	Colour box	6	24

TARTARUGA-XXL2





# TURTLE



TURTLE-B



TURTLE-N



Protection class



Insulation class



intertek

Codice Prodotto Item code Code Codigo Code	Alimentazione Power source Alimentation Alimentación Stromversorgung	Tecnologia della Luce Light technology Technologie de la lumière Tecnología de iluminación Beleuchtungstechnologie	Potenza (W) Watt power Puissance Potencia Leistung	Materiale Material Materiál Material Material
<b>TURTLE-B</b>	220V-240V ~ 50/60 Hz	E27 Lamp holder	Max 60W	Glass + plastic
<b>TURTLE-N</b>	220V-240V ~ 50/60 Hz	E27 Lamp holder	Max 60W	Glass + plastic

**Descrizione** / Description / Description / Descripción / Beschreibung:

Applique ovale E27  
E27 bulkheads  
Hublots E27  
Applique E27  
E27-Wandleuchte

**Accessori inclusi** / Accessories included / Accessoires fournis / Accesorios incluidos / Mitgeliefertes Zubehör:



**Kit di installazione**  
Installation kit

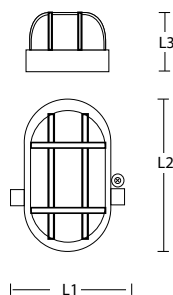

Codice Prodotto Item code Code Codigo Code	Lunghezza L1 Length Longueur Lungitud Länge	Larghezza L2 Width Largeur Ancho Breite	Altezza L3 Height Hauteur Altura Höhe	Imballo Packing Emballage Embalaje Verpackung	Inner Pcs	Master Pcs
<b>TURTLE-B</b>	175 mm	125 mm	65 mm	Shrink	12	24
<b>TURTLE-N</b>	175 mm	125 mm	65 mm	Shrink	12	24

TURTLE-B



TURTLE-N



# APPLIQUE DA ESTERNO

E27 bulkheads / Hublots E27 / Applique E27 / E27-Wandleuchten



## DAFT



IS701



Protection class



Insulation class



Codice Prodotto Item code Code Codigo Code	Alimentazione Power source Alimentation Alimentación Stromversorgung	Tecnologia della Luce Light technology Technologie de la lumière Tecnología de iluminación Beleuchtungstechnologie	Potenza (W) Watt power Puissance Potencia Leistung	Apertura Fascio Kind of beam Type of faisceau Tipo de haz Ausstrahlungswinkel	Materiale Material Materiau Material Material
<b>IS701</b>	220V-240V ~ 50/60 Hz	E27 Lamp holder (bulb not included)	Max 60W	Diffuse 120°	Plastic + Aluminium

### Descrizione / Description / Description / Descripción / Beschreibung:

Applique E27 antracite  
Dark grey E27 bulkhead  
Hublot E27 anthracite  
Applique E27 gris oscura  
E27-Wandleuchte Anthrazit

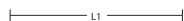
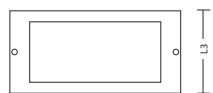
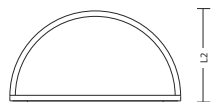

### Accessori inclusi / Accessories included / Accessoires fournis / Accesorios incluidos / Mitgeliefertes Zubehör:



Kit di installazione  
Installation kit

Codice Prodotto Item code Code Codigo Code	Lunghezza L1 Length Longueur Lungitud Länge	Larghezza L2 Width Largeur Ancho Breite	Altezza L3 Height Hauteur Altura Höhe	Imballo Packing Emballage Embalaje Verpackung	Inner Pces	Master Pces
<b>IS701</b>	249 mm	120 mm	158 mm	Colour box	6	12

IS701





IS702



Protection class



Insulation class



Codice Prodotto Item code Code Codigo Code	Alimentazione Power source Alimentation Alimentación Stromversorgung	Tecnologia della Luce Light technology Technologie de la lumière Tecnología de iluminación Beleuchtungstechnologie	Potenza (W) Watt power Puissance Potencia Leistung	Apertura Fascio Kind of beam Type de faisceau Tipo de haz Ausstrahlungswinkel	Materiale Material Materiau Material Material
<b>IS702</b>	220V-240V ~ 50/60 Hz	E27 Lamp holder (bulb not included)	Max 60W	Diffuse 120°	Plastic + Aluminium

**Descrizione / Description / Description / Descripción / Beschreibung:**

Applique E27 antracite  
Dark grey E27 bulkhead  
Hublot E27 anthracite  
Aplique E27 gris oscura  
E27-Wandleuchte Anthrazit



**Accessori inclusi / Accessories included / Accessoires fournis / Accesorios incluidos / Mitgeliefertes Zubehör:**



**Kit di installazione**  
Installation kit

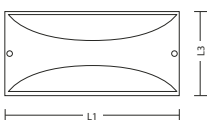
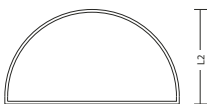

Codice Prodotto Item code Code Codigo Code	Lunghezza L1 Length Longueur Lungitud Länge	Larghezza L2 Width Largeur Ancho Breite	Altezza L3 Height Hauteur Altura Höhe	Imballo Packing Emballage Embalaje Verpackung	Inner Pcs	Master Pcs
<b>IS702</b>	249 mm	120 mm	158 mm	Colour box	6	12

IS702



# APPLIQUE DA ESTERNO

E27 bulkheads / Hublots E27 / Applique E27 / E27-Wandleuchten

## DJARIN



IS703



Protection class



Insulation class



Codice Prodotto Item code Code Codigo Code	Alimentazione Power source Alimentation Alimentación Stromversorgung	Tecnologia della Luce Light technology Technologie de la lumière Tecnología de iluminación Beleuchtungstechnologie	Potenza (W) Watt power Puissance Potencia Leistung	Apertura Fascio Kind of beam Type de faisceau Tipo de haz Ausstrahlungswinkel	Materiale Material Materiau Material Material
<b>IS703</b>	220V-240V ~ 50/60 Hz	E27 Lamp holder (bulb not included)	Max 60W	Diffuse 120°	Plastic + Aluminium

### Descrizione / Description / Description / Descripción / Beschreibung:

Applique E27 antracite  
Dark grey E27 bulkhead  
Hublot E27 anthracite  
Applique E27 gris oscuro  
E27-Wandleuchte Anthrazit

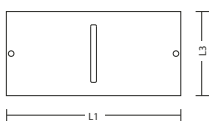

### Accessori inclusi / Accessories included / Accessoires fournis / Accesorios incluidos / Mitgeliefertes Zubehör:



Kit di installazione  
Installation kit

Codice Prodotto Item code Code Codigo Code	Lunghezza L1 Length Longueur Lungitud Länge	Larghezza L2 Width Largeur Ancho Breite	Altezza L3 Height Hauteur Altura Höhe	Imballo Packing Emballage Embalaje Verpackung	Inner Pcs	Master Pcs
<b>IS703</b>	249 mm	120 mm	158 mm	Colour box	6	12

IS703



BRIK



Outdoor lighting



IS720



Protection class



Insulation class



intertek



Codice Prodotto Item code Code Codigo Code	Alimentazione Power source Alimentation Alimentación Stromversorgung	Tecnologia della Luce Light technology Technologie de la lumière Tecnología de iluminación Beleuchtungstechnologie	Potenza (W) Watt power Puissance Potencia Leistung	Apertura Fascio Kind of beam Type de faisceau Tipo de haz Ausstrahlungswinkel	Materiale Material Materiail Material Material
IS720	220V-240V ~ 50/60 Hz	E27 Lamp holder	max 40W	Diffuse	Glass + Plastic + Aluminium

## Descrizione / Description / Description / Descripción / Beschreibung:

Lampada segnapasso da parete in alluminio con scatola da incasso  
 Aluminium outdoor recessed wall light  
 Spot à encastrer extérieur en fonte d'aluminium  
 Lámpara cuenta pasos de aluminio con caja para empotrar en pared  
 Aluminium-Wandleuchte mit versenkter Box



## Accessori inclusi / Accessories included / Accessoires fournis / Accesorios incluidos / Mitgeliefertes Zubehör:



Scatola da incasso  
Recessed mounting box



Kit di installazione  
Installation kit

Codice Prodotto Item code Code Codigo Code	Lunghezza L1 Length Longueur Lungitud Länge	Larghezza L2 Width Largeur Ancho Breite	Altezza L3 Height Hauteur Altura Höhe	Imballo Packing Emballage Embalaje Verpackung	Inner Pces	Master Pces
IS720	329 mm	101 mm	93,8 mm	Shrink	6	18

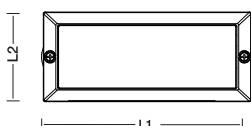

IS720





# SPOT DA ESTERNO

Outdoor spotlights / Spots extérieurs / Focos de exterior / Außenstrahler

## SHAFT



IS728



Protection class



Insulation class



Outdoor lighting



Codice Prodotto Item code Code Codigo Code	Alimentazione Power source Alimentation Alimentación Stromversorgung	Tecnologia della Luce Light technology Technologie de la lumière Tecnología de iluminación Beleuchtungstechnologie	Potenza (W) Watt power Puissance Potencia Leistung	Apertura Fascio Kind of beam Type de faisceau Tipo de haz Ausstrahlungswinkel	Temp. di funzionamento Working temperature Température de fonctionnement Temperatura de funcionamiento Betriebstemperatur	Peso max supp. Max. supp. weight Poids max. supporté Peso máx. soportado Max. Gewicht unterstützt	Materiale Material Materiau Material Material
IS728	220V-240V ~ 50Hz	GU10 Lamp holder (Bulb not included) LED compatible	Max 10W	Focus	-20°/+50°C	1000 Kg	Steel INOX 316

### Descrizione / Description / Description / Descripción / Beschreibung;

Faretto da incasso per esterno  
Outdoor recessed spotlight  
Spot encastrable extérieur  
Foco empotrable para exterior  
Einbaustrahler für den Außenbereich

### Accessori inclusi / Accessories included / Accessoires fournis / Accesorios incluidos / Mitgeliefertes Zubehör:



Cavo / Cable / Cable / Câble / Kabel:  
25 cm



Codice Prodotto Item code Code Codigo Code	Diametro D1 Diameter Diámetro Diámetro Breite	Altezza L1 Height Hauteur Altura Höhe	Imballo Packing Emballage Embalaje Verpackung	Inner Pces	Master Pces
IS728	ø 93 mm	100 mm	Colour box	4	12

IS728





## BELIZE

LED

INOX  
304

NEW



IS727

Protection  
classInsulation  
classContaining  
product

Codi. Prod. Item code Code Codigo Code	Alimentazione Power source Alimentation Stromversorgung	Tecnologia della Luce Light technology Technologie de la lumière Tecnología de iluminación Beleuchtungstechnologie	Potenza (W) Watt power Puissance Potencia Leistung	Tipo di luce Kelvin degrees Degrés Kelvin Temp. de luz °K	Lumen Lumen Lumen Lumen	Apertura Fascio Kind of beam Type de faisceau Tipo de haz Ausstrahlungswinkel	Temp. di funzionamento Working temperature Température de fonct. Temperatura de func. Betriebstemperatur	Peso max supp. Max. supp. weight Poids max. supporté Peso máx. soportado Max. Gewicht unterstützt	Materiale Material Materiau Material Material
IS727	220V-240V ~ 50Hz	SMD LED	7W	3000K	500 Lm	Focus 110°	-20°/+50°C	500 Kg	Steel INOX 304

## Descrizione / Description / Description / Descripción / Beschreibung:

Faretto LED da incasso per esterno

LED Outdoor recessed spotlight

Spot LED encastrable extérieur

Foco LED empotrable para exterior

LED Einbaustrahler für den Außenbereich

## Accessori inclusi / Accessories included / Accessoires fournis / Accesorios incluidos / Mitgeliefertes Zubehör:

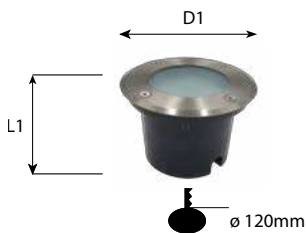

Codice Prodotto Item code Code Codigo Code	Diametro D1 Diameter Diamètre Diámetro Breite	Altezza L1 Height Hauteur Altura Höhe	Imballo Packing Emballage Embalaje Verpackung	Inner Pcs	Master Pcs
IS727	130 mm	85 mm	Colour box	4	16

IS727



# SPOT DA ESTERNO

Outdoor spotlights / Spots extérieurs / Focos de exterior / Außenstrahler

## BLACKBIRD



SL368



Protection class

Codice Prodotto Item code Code Codigo Code	Alimentazione Power source Alimentation Alimentación Stromversorgung	Tecnologia della Luce Light technology Technologie de la lumière Tecnología de iluminación Beleuchtungstechnologie	Potenza (W) Watt power Puissance Potencia Leistung	Lumen Lumen Lumen Lumen	Autonomia Runtime Autonomie Autonomia Autonomie	Materiale Material Materiau Material Material	Apertura Fascio Kind of beam Type de faisceau Tipo de haz Ausstrahlungswinkel	Cavo Cable Cable Cable Kabel
SL368	Monocrystal silicon solar panel: 6V 3W Battery: Li-ion 3,7V 3600mAh type 18650 (included) Replaceable	SMD LED	2 X 3W	2 x 100 Lm	100%: 12 ore / hrs 75%: 18 ore / hrs 50%: 30 ore / hrs	Aluminium (spotlight) ABS (solar panel)	Focus	2 x 3m

### Descrizione / Description / Description / Descripción / Beschreibung:

Kit di 2 faretti LED in alluminio a carica solare  
Kit of 2 solar-charged aluminum LED spotlights  
Kit de 2 spots LED en aluminium à charge solaire  
Kit de 2 focos LED de aluminio con carga solar  
Set mit 2 solar geladenen LED-Strahlern aus Aluminium

### Accessori inclusi / Accessories included / Accessoires fournis / Accesorios incluidos / Mitgeliefertes Zubehör:

3 tasselli di plastica + 3 viti  
3 plastic dowels + 3 screws

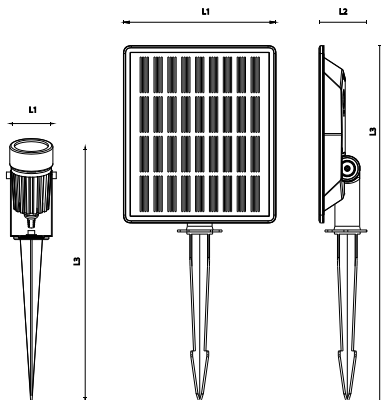

Angolo di rilevazione / Degrees motion sensor / Angle / Grados de sensor / Erfassungswinkel	120°
Tempo di funzionamento / Working time / Temps de fonctionnement / Tiempo de funcionamiento / Betriebszeit	25 sec

Codice prodotto Item code Code Codigo Code	Lunghezza L1 Length Longueur Lungitud Länge	Larghezza L2 Width Largeur Ancho Breite	Altezza L3 Height Hauteur Altura Höhe	Imballo Packing Emballage Embalaje Verpackung	Inner Pcs	Master Pcs
SL368 Spotlightlight: Panel:	46,6 mm 154 mm	46,6 mm 47 mm	252 mm 357 mm	Colour box	4	16

SL368





## SNAIL



IS726



Protection class



Insulation class



Codice Prodotto Item code Code Codigo Code	Alimentazione Power source Alimentation Alimentación Stromversorgung	Tecnologia della Luce Light technology Technologie de la lumière Tecnología de iluminación Beleuchtungstechnologie	Potenza (W) Watt power Puissance Potencia Leistung	Apertura Fascio Kind of beam Type de faisceau Tipo de haz Ausstrahlungswinkel	Materiale Material Materiu Material Material
IS726	220V-240V ~ 50Hz	GU10 Lamp holder (Bulb not included) LED compatible	Max 28W	Focus	Aluminium

**Descrizione** / Description / Descripción / Beschreibung:

Faretto da esterno con picchetto

Outdoor spotlight with spike

Spot d'extérieur à piquer

Foco de exterior con pincho

Außenstrahler mit Erdspeiß

**Accessori inclusi** / Accessories included / Accessoires fournis / Accesorios incluidos / Mitgeliefertes Zubehör:



**Cavo** / Cable / Câble / Kabel:  
H0SRN-F3G1.0mm<sup>2</sup> 1,5 mt



**Picchetto** / Spike / Piquet / Pincho / Erdspeiß



Codice Prodotto Item code Code Codigo Code	Diametro D1 Diameter Diamètre Diámetro Breite	Altezza L1 Height Hauteur Altura Höhe	Imballo Packing Emballage Embalaje Verpackung	Inner Pces	Master Pces
IS726	ø 100 mm	326 mm	Colour box	6	24

IS726



# SPOT DA ESTERNO

Outdoor spotlights / Spots extérieurs / Focos de exterior / Außenstrahler

## PRINCE



Outdoor lighting



CRI > 80



25.000 hrs



Not Dimmable



Protection class



Insulation class



Containing product



IS730



Codice Prodotto Item code Code Codigo Code	Alimentazione Power source Alimentation Alimentación Stromversorgung	Tecnologia della Luce Light technology Technologie de la lumière Tecnología de iluminación Beleuchtungstechnologie	Potenza (W) Watt power Puissance Potencia Leistung	Lumen Lumen Lumen Lumen	Tipo di luce Kelvin degrees Degrés Kelvin Temperatura de luz °K	Apertura Fascio Kind of beam Type de faisceau Tipo de haz Ausstrahlungswinkel	Materiale Material Materiau Material Material
IS730	220V-240V ~ 50 Hz	COB LED	6W	300 Lm	4000K	Focus 60°	Aluminium + Glass

### Descrizione / Description / Description / Descripción / Beschreibung:

Faretto LED da esterno con picchetto  
LED Outdoor spotlight with spike  
Spot d'extérieur LED à piquet  
Foco LED de exterior con pincho  
LED-Außenstrahler mit Erdspeiß

### Accessori inclusi / Accessories included / Accessoires fournis / Accesorios incluidos / Mitgeliefertes Zubehör:



Cavo / Cable / Cable / Câble / Kabel:  
H0SRN-F3G1.0mm² 80 cm



Picchetto / Spike / Piquet / Pincho / Erdspeiß

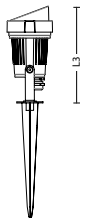

Codice prodotto Item code Code Codigo Code	Larghezza L1 Width Largeur Ancho Breite	Lunghezza L2 Length Longueur Lungitud Länge	Altezza L3 Height Hauteur Altura Höhe	Imballo Packing Emballage Embalaje Verpackung	Inner Pces	Master Pces
IS730	72 mm	60 mm	115 mm	Colour box	4	12

IS730





Outdoor lighting

# PADLIGHT 5



IS740-5-4000K



IS745-5-4000K



IS755-5-4000K



IS760-5-4000K



CRI > 80



25.000 hrs



15000 Switch



Not Dimmable



Protection class



Insulation class



Energy class



Codice Prodotto Item code Code Codigo Code	Alimentazione Power source Alimentation Alimentación Stromversorgung	Tecnologia della Luce Light technology Technologie de la lumière de iluminación Beleuchtungstechnologie	Potenza (W) Watt power Puissance Potencia Leistung	Lumen Lumen Lumen Lumen	Tipo di luce Kelvin degrees Degrés Kelvin Temperatura de luz °K	Materiale Material Materiau Material Material	Apertura Fascio Kind of beam Type de faisceau Tipo de haz Ausstrahlungswinkel
IS740-5-4000K	220-240V ~ 50 Hz	2835 SMD LED	10W	800 Lm		Die cast aluminium	Diffuse 100°
IS745-5-4000K	220-240V ~ 50 Hz	2835 SMD LED	20W	1600 Lm		Die cast aluminium	Diffuse 100°
IS755-5-4000K	220-240V ~ 50 Hz	2835 SMD LED	30W	2400 Lm		Die cast aluminium	Diffuse 100°
IS760-5-4000K	220-240V ~ 50 Hz	2835 SMD LED	50W	4000 Lm		Die cast aluminium	Diffuse 100°

**Descrizione / Description / Description / Descripción / Beschreibung:**

Faro LED da esterno  
LED outdoor floodlight  
Phare extérieur LED  
Faro exterior de LED  
Flutlicht für Außenbereiche

**Accessori inclusi / Accessories included / Accessoires fournis / Accesorios incluidos / Mitgeliefertes Zubehör:**

Cavo 15cm VDE  
Câble 15cm VDE  
Cable 15cm VDE  
Cable 15cm VDE  
Kabel 15cm VDE

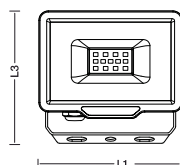

Codice prodotto Item code Code Codigo Code	Lunghezza L1 Length Longueur Lungitud Länge	Larghezza L2 Width Largeur Ancho Breite	Altezza L3 Height Hauteur Altura Höhe	Imballo Packing Emballage Embalaje Verpackung	Inner Pcs	Master Pcs
IS740-5-4000K	108 mm	24 mm	100 mm	Colour box	10	40
IS745-5-4000K	143 mm	24 mm	130 mm	Colour box	10	40
IS755-5-4000K	187 mm	24 mm	167 mm	Colour box	8	32
IS760-5-4000K	217 mm	26 mm	185 mm	Colour box	8	16

IS740-5-4000K



IS745-5-4000K



IS755-5-4000K



IS760-5-4000K





# PADLIGHT 5 + PIR



IS743-5-4000K



IS748-5-4000K



IS768-5-4000K



CRI > 80



25.000 hrs



15000 Switch



Not Dimmable



Protection class



Insulation class



Energy class



Codice Prodotto Item code Code Codigo Code	Alimentazione Power source Alimentation Alimentación Stromversorgung	Tecnologia della Luce Light technology Technologie de la lumière Tecnología de iluminación Beleuchtungstechnologie	Potenza (W) Watt power Puissance Potencia Leistung	Lumen Lumen Lumen Lumen Lumen	Tipo di luce Kelvin degrees Degrés Kelvin Temperatura de luz °K	Materiale Material Materiau Material Material	Apertura Fascio Kind of beam Type de faisceau Tipo de haz Ausstrahlungswinkel
IS743-5-4000K	220-240V ~ 50 Hz	2835 SMD LED	10W	800 Lm	<b>4000K</b> <b>COOL WHITE</b>	Die cast aluminium	Diffuse 100°
IS748-5-4000K	220-240V ~ 50 Hz	2835 SMD LED	20W	1600 Lm		Die cast aluminium	Diffuse 100°
IS768-5-4000K	220-240V ~ 50 Hz	2835 SMD LED	50W	4000 Lm		Die cast aluminium	Diffuse 100°

**Descrizione / Description / Description / Descripción / Beschreibung:**

Faro LED da esterno  
LED outdoor floodlight  
Phare extérieur LED  
Faro exterior de LED  
Flutlicht für Außenbereiche

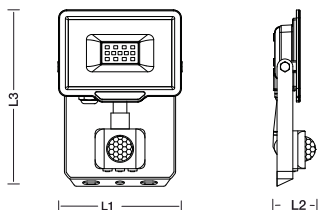

IS743-5-4000K



IS748-5-4000K



IS768-5-4000K



<b>Angolo di rilevazione / Degrees motion sensor / Angle / Grados de sensor / Erfassungswinkel</b>	120°
<b>Raggio d'azione / Detection range / Rayon d'action / Rayo de accion / Reichweite</b>	4-10 m
<b>Tempo di funzionamento / Working time / Temps de fonctionnement / Tiempo de funcionamiento / Betriebszeit</b>	from 10 sec up to 8 min approx

**Accessori inclusi / Accessories included / Accessoires fournis / Accesorios incluidos / Mitgeliefertes Zubehör:**

Cavo 15cm VDE  
Câble 15cm VDE  
Cable 15cm VDE  
Cable 15cm VDE  
Kabel 15cm VDE

Codice prodotto Item code Code Codigo Code	Lunghezza L1 Length Longueur Lungitud Länge	Larghezza L2 Width Largeur Ancho Breite	Altezza L3 Height Hauteur Altura Höhe	Imballo Packaging Emballage Embalaje Verpackung	Inner Pces	Master Pces
IS743-5-4000K	108 mm	55 mm	155 mm	Colour box	6	36
IS748-5-4000K	143 mm	55 mm	180 mm	Colour box	6	24
IS768-5-4000K	217 mm	45 mm	230 mm	Colour box	4	16



# PADLIGHT 5

Outdoor lighting



IS740-5-6500K



IS745-5-6500K



IS755-5-6500K



IS760-5-6500K



CRI > 80



25.000 hrs



15000 Switch



Not Dimmable



Protection class



Insulation class



Energy class



Codice Prodotto Item code Code Codigo Code	Alimentazione Power source Alimentation Alimentación Stromversorgung	Tecnologia della Luce Light technology Technologie de la lumière Tecnología de iluminación Beleuchtungstechnologie	Potenza (W) Watt power Puissance Potencia Leistung	Lumen Lumen Lumen Lumen Lumen	Tipo di luce Kelvin degrees Degrés Kelvin Temperatura de luz °K	Materiale Material Materiau Material Material	Apertura Fascio Kind of beam Type de faisceau Tipo de haz Ausstrahlungswinkel
IS740-5-6500K	220-240V ~ 50 Hz	2835 SMD LED	10W	800 Lm	<b>6500K</b> COLD LIGHT	Die cast aluminium	Diffuse 100°
IS745-5-6500K	220-240V ~ 50 Hz	2835 SMD LED	20W	1600 Lm		Die cast aluminium	Diffuse 100°
IS755-5-6500K	220-240V ~ 50 Hz	2835 SMD LED	30W	2400 Lm		Die cast aluminium	Diffuse 100°
IS760-5-6500K	220-240V ~ 50 Hz	2835 SMD LED	50W	4000 Lm		Die cast aluminium	Diffuse 100°

**Descrizione / Description / Description / Descripción / Beschreibung:**

Faro LED da esterno  
LED outdoor floodlight  
Phare extérieur LED  
Faro exterior de LED  
Flutlicht für Außenbereiche

**Accessori inclusi / Accessories included / Accessoires fournis / Accesorios incluidos / Mitgeliefertes Zubehör:**

Cavo 15cm VDE  
Cable 15cm VDE  
Cable 15cm VDE  
Cable 15cm VDE  
Kabel 15cm VDE

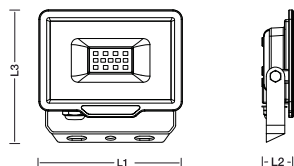

Codice prodotto Item code Code Codigo Code	Lunghezza L1 Length Longueur Lungitud Länge	Larghezza L2 Width Largeur Ancho Breite	Altezza L3 Height Hauteur Altura Höhe	Imballo Packing Emballage Embalaje Verpackung	Inner Pcs	Master Pcs
IS740-5-6500K	108 mm	24 mm	100 mm	Colour box	10	40
IS745-5-6500K	143 mm	24 mm	130 mm	Colour box	10	40
IS755-5-6500K	187 mm	24 mm	167 mm	Colour box	8	32
IS760-5-6500K	217 mm	26 mm	185 mm	Colour box	8	16

IS740-5-6500K



IS745-5-6500K



IS755-5-6500K



IS760-5-6500K







# PADLIGHT 5 + PIR



IS743-5-6500K



IS748-5-6500K



IS768-5-6500K



CRI > 80



25,000 hrs



15000 Switch



Not Dimmable



Protection class



Insulation class



Energy class



Codice Prodotto Item code Code Codigo Code	Alimentazione Power source Alimentation Alimentación Stromversorgung	Tecnologia della Luce Light technology Technologie de la lumière tecnología de iluminación Beleuchtungstechnologie	Potenza (W) Watt power Puissance Potencia Leistung	Lumen Lumen Lumen Lumen	Tipo di luce Kelvin degrees Degrés Kelvin Temperatura de luz °K	Materiale Material Materiau Material Material	Apertura Fascio Kind of beam Type de faisceau Tipo de haz Ausstrahlungswinkel
IS743-5-6500K	220-240V ~ 50 Hz	2835 SMD LED	10W	800 Lm		Die cast aluminium	Diffuse 100°
IS748-5-6500K	220-240V ~ 50 Hz	2835 SMD LED	20W	1600 Lm		Die cast aluminium	Diffuse 100°
IS768-5-6500K	220-240V ~ 50 Hz	2835 SMD LED	50W	4000 Lm		Die cast aluminium	Diffuse 100°

**Descrizione / Description / Description / Descripción / Beschreibung:**

Faro LED da esterno  
LED outdoor floodlight  
Phare extérieur LED  
Faro exterior de LED  
Flutlicht für Außenbereiche

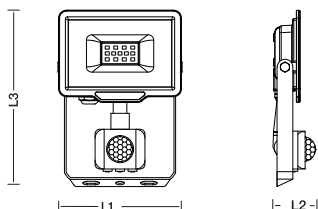

IS743-5-6500K



IS748-5-6500K



IS768-5-6500K



<b>Angolo di rilevazione</b> /Degrees motion sensor/ Angle / Grados de sensor / Erfassungswinkel	120°
<b>Raggio d'azione</b> / Detection range / Rayon d'action / Rayo de accion / Reichweite	4-10 m
<b>Tempo di funzionamento</b> / Working time / Temps de fonctionnement / Tiempo de funcionamiento / Betriebszeit	from 10 sec up to 8 min approx

**Accessori inclusi / Accessories included / Accessoires fournis / Accesorios incluidos / Mitgeliefertes Zubehör:**

Cavo 15cm VDE  
Câble 15cm VDE  
Cable 15cm VDE  
Cable 15cm VDE  
Kabel 15cm VDE

Codice prodotto Item code Code Codigo Code	Lunghezza L1 Length Longueur Lungitud Länge	Larghezza L2 Width Largeur Ancho Breite	Altezza L3 Height Hauteur Altura Höhe	Imballo Packing Emballage Embalaje Verpackung	Inner Pces	Master Pces
IS743-5-6500K	108 mm	55 mm	155 mm	Colour box	6	36
IS748-5-6500K	143 mm	55 mm	180 mm	Colour box	6	24
IS768-5-6500K	217 mm	45 mm	230 mm	Colour box	4	16



Outdoor lighting

PROIETTORI SMD

SMD floodlights / Projecteurs SMD / Projectores SMD / SMD Strahler

## PADLIGHT POWER



CRI > 80



25.000 hrs



15000  
Switch



Not Dimmable



Protection class



Insulation class



Energy class



Codice Prodotto Item code Code Codigo Code	Alimentazione Power source Alimentation Alimentación Stromversorgung	Tecnologia della Luce Light technology Technologie de la lumière Tecnología de iluminación Beleuchtungstechnologie	Potenza (W) Watt power Puissance Potencia Leistung	Consumo elettrico (W) Consumption Consummation Verbrauch	Lumen Lumen Lumen Lumen	Tipo di luce Kelvin degrees Degrés Kelvin Temperatura de luz °K	Materiale Material Materiau Material Material	Apertura Fascio Kind of beam Tipo de faisceau Tipo de haz Ausstrahlungswinkel
IS781	220-240V ~ 50/60 Hz	LED SMD	100W	100W	8500 Lm		Die cast aluminium	Diffuse 120°
IS783	220-240V ~ 50/60 Hz	LED SMD	150W	150W	13000 Lm		Die cast aluminium	Diffuse 120°
IS786	220-240V ~ 50/60 Hz	LED SMD	200W	200W	17000 Lm		Die cast aluminium	Diffuse 120°

Descrizione / Description / Description / Descripción / Beschreibung:

Faro LED da esterno  
LED outdoor floodlight  
Phare extérieur LED  
Faro exterior de LED  
Flutlicht für Außenbereiche

Accessori inclusi / Accessories included / Accessoires fournis / Accesorios incluidos / Mitgeliefertes Zubehör:

**IS781:**  
Cavo 15cm VDE  
Câble 15cm VDE  
Cable 15cm VDE  
Cable 15cm VDE  
Kabel 15cm VDE

**IS783-IS786:**  
Cavo 30cm VDE  
Câble 30cm VDE  
Cable 30cm VDE  
Cable 30cm VDE  
Kabel 30cm VDE

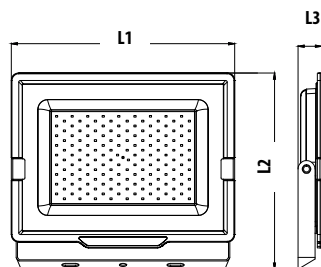

Codice prodotto Item code Code Codigo Code	Lunghezza L1 Length Longueur Lungitud Länge	Larghezza L2 Width Largeur Ancho Breite	Altezza L3 Height Hauteur Altura Höhe	Imballo Packing Emballage Embalaje Verpackung	Inner Pces	Master Pces
IS781	287 mm	32 mm	235 mm	Colour box	4	8
IS783	328 mm	35 mm	288 mm	Colour box	2	4
IS786	382 mm	35 mm	330 mm	Colour box	-	4



# PROIETTORI SMD

SMD floodlights / Projecteurs SMD / Projectores SMD / SMD Strahler

## PADLIGHT RGB



IS744



### ADDITIONAL RC



RC744



25.000 hrs



15000  
Switch



Protection  
class



Insulation  
class



RGB

Codice Prodotto Item code Code Codigo Code	Alimentazione Power source Alimentation Alimentación Stromversorgung	Tecnologia della Luce Light technology Technologie de la lumière Tecnología de iluminación Beleuchtungstechnologie	Potenza (W) Watt power Puissance Potencia Leistung	Consumo elettrico (W) Consumption Consummation Verbrauch	Lumen Lumen Lumen Lumen	Tipo di luce Kelvin degrees Degrés Kelvin Temperatura de luz °K	Materiale Material Materiau Material Material	Apertura Fascio Kind of beam Type de faisceau Tipo de haz Ausstrahlungswinkel
IS744	220V-240V ~ 50/60 Hz	SMD LED	20W	20W	N/A	-	Aluminium	Diffuse 100°
RC744	1 x CR2025 (included)	-	-	-	-	-	-	-

**Descrizione** / Description / Description / Descripción / Beschreibung:

Faro LED RGB da esterno 20W  
20W RGB LED outdoor floodlight  
Phare extérieur LED RGB 20W  
Foco proyector Led RGB multicolor de 20W para exterior  
20W RGB LED multi-color Außenlampe

**Accessori inclusi** / Accessories included / Accessoires fournis / Accesorios incluidos / Mitgeliefertes Zubehör:

1 x Telecomando / Remote control



EASY CONNECTION

WATER RESISTANT

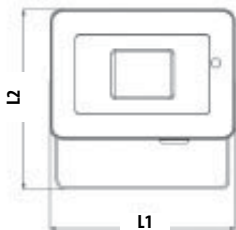
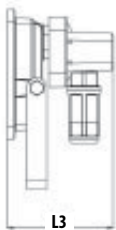

Codice prodotto Item code Code Codigo Code	Lunghezza L1 Length Longueur Lungitud Länge	Larghezza L2 Width Largeur Ancho Breite	Altezza L3 Height Hauteur Altura Höhe	Imballo Packing Emballage Embalaje Verpackung	Inner Pces	Master Pces
IS744	136 mm	77.5 mm	132 mm	Colour box	6	24
RC744				Polybag	1	20

IS744



RC744





## COLOUR PARTY LIGHT

15 m

LED



PS066



Codice Prod. Item code Code Codigo Code	Alimentazione Power source Alimentation Alimentación Stromversorgung	Tecnologia della Luce Light technology Technologie de la lumière Tecnología de iluminación Beleuchtungstechnologie	Tipo di lampadina Bulb Type Type de l'ampoule Tipo de bombilla Leuchtmitteltyp	Potenza (W) Watt power Puissance Potencia Leistung	Consumo elettrico (W) Consumption Consumation Verbrauch	Lumen Lumen Lumen Lumen	Tipo di luce Kelvin degrees Degrés Kelvin Temperatura de luz °K	Materiale Material Materiau Material Material	Cavo Cable Câble Cable Kabel
PS066	24V~9W AC/DC adaptor	5 pcs x SMD 2835 LED / bulb	G50 (ø 50 mm) not replaceable	0,34W / bulb	0,34W / bulb	25 Lm / bulb	-	Rubber	Black: 3 m + 12 m PVC ø4.3 mm 2 x 0.2 mm <sup>2</sup>

### Descrizione / Description / Description / Descripción / Beschreibung:

Catenaria luminosa prolungabile con 20 lampadine LED  
20 LED bulbs extendable light chain  
Guirlande lumineuse prolongeable avec 20 ampoules LED  
Guirnalda luminosa extensible con 20 bombillas LED  
20LED-Glühlampen Lichterkette, ausziehbar

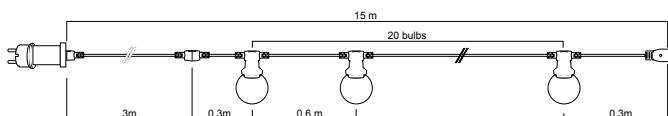

### Collegamenti massimi / Maximum connections / Connexions maximales

Fino a 3 catenarie dello stesso codice / Up to 3 light chains of the same code



HANGABLE

Codice prodotto Item code Code Codigo Code	Lunghezza L1 Length Longueur Lungitud Länge	Larghezza L2 Width Largeur Ancho Breite	Altezza L3 Height Hauteur Altura Höhe	Imballo Packing Emballage Embalaje Verpackung	Inner Pcs	Master Pcs
PS066	15000mm	50mm	112mm	Colour box	4	8

PS066



# CATENARIE LUMINOSE

Extendable light chains / Guirlandes lumineuses / Guiraldas luminosas / Ausziehbare Lichterkette



Outdoor lighting

## CLASSY PARTY LIGHT

NEW

15 m

LED



PS067N



Codice Prod. Item code Code Codigo Code	Alimentazione Power source Alimentation Alimentación Stromversorgung	Tecnologia della Luce Light technology Technologie de la lumière Tecnología de iluminación Beleuchtungstechnologie	Tipo di lampadina Bulb Type Type de l'ampoule Tipo de bombilla Leuchtmitteltyp	Potenza (W) Watt power Puissance Potencia Leistung	Consumo elettrico (W) Consumption Consummation Verbrauch	Lumen Lumen Lumen Lumen	Tipo di luce Kelvin degrees Degrés Kelvin Temperatura de luz °K	Materiale Material Materiau Material Material	Cavo Cable Câble Cable Kabel
PS067N	24V~9W AC/DC adaptor	5 pcs x SMD 2835 LED / bulb	G50 (ø 50 mm) not replaceable	0,35W / bulb	0,35W / bulb	55 Lm / bulb	3000K	PVC+ABS	White:: 3 m + 12 m PVC ø4.4 mm 2 x 0.2 mm <sup>2</sup>

### Descrizione / Description / Description / Descripción / Beschreibung:

Catenaria luminosa prolungabile con 20 lampadine LED  
20 LED bulbs extendable light chain  
Guirlande lumineuse prolongeable avec 20 ampoules LED  
Guirnalda luminosa extensible con 20 bombillas LED  
20 LED-Glühlampen Lichterkette, ausziehbar

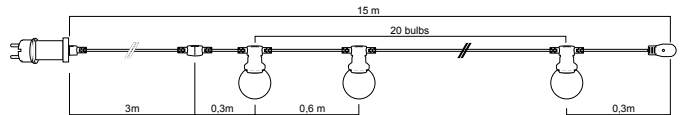

### Collegamenti massimi / Maximum connections / Connexions maximales

Fino a 3 catenarie dello stesso codice / Up to 3 light chains of the same code

Codice prodotto Item code Code Codigo Code	Lunghezza L1 Length Longueur Lungitud Länge	Larghezza L2 Width Largeur Ancho Breite	Altezza L3 Height Hauteur Altura Höhe	Imballo Packing Emballage Embalaje Verpackung	Inner Pces	Master Pces
PS067N	15000mm	50mm	112mm	Colour box	4	8



PS067N





# RETRO' PARTY LIGHT

7.5 m

LED



PS048



Codice Prod. Item code Code Codigo Code	Alimentazione Power source Alimentation Alimentación Stromversorgung	Tecnologia della Luce Light technology Technologie de la lumière Tecnología de iluminación Beleuchtungstechnologie	Tipo di lampadina Bulb Type Type de ampoule Tipo de bombilla Leuchtmitteltyp	Potenza (W) Watt power Puissance Potencia Leistung	Consumo elettrico (W) Consumption Consommation Verbrauch	Lumen Lumen Lumen Lumen	Tipo di luce Kelvin degrees Degrés Kelvin Temperatura de luz °K	Materiale Material Materiu Material Material	Cavo Cable Câble Cable Kabel
PS048	24V~9W AC/DC adaptor	LED ø 5 (filament)	G50 (ø 50 mm) not replaceable	0,07W / bulb	0,07W / bulb	5 Lm / bulb	2200K	Rubber	Black: 2.5 m + 5 m Rubber ø4.3 mm 2 x 0.2 mm <sup>2</sup>

**Descrizione / Description / Description / Descripción / Beschreibung:**

Catenaria luminosa prolungabile con 10 lampadine LED  
 10 LED bulbs extendable light chain  
 Guirlande lumineuse prolongeable avec 10 ampoules LED  
 Guirnalda luminosa extensible con 10 bombillas LED  
 10 LED-Glühlampen Lichterkette, ausziehbar

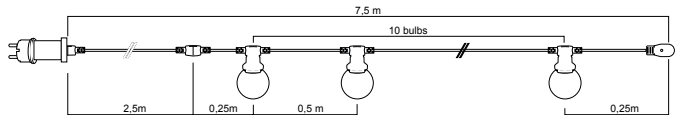

Collegamenti massimi / Maximum connections / Connexions maximales

Fino a 3 catenarie dello stesso codice / Up to 3 light chains of the same code



HANGABLE

Codice prodotto Item code Code Codigo Code	Lunghezza L1 Length Longueur Lungitud Länge	Larghezza L2 Width Largeur Ancho Breite	Altezza L3 Height Hauteur Altura Höhe	Imballo Packing Emballage Embalaje Verpackung	Inner Pces	Master Pces
PS048	7500mm	50mm	112mm	Colour box	4	16

PS048



# CATENARIE LUMINOSE

Extendable light chains / Guirlandes lumineuses / Guiraldas luminosas / Ausziehbare Lichterkette

## RETRO' PARTY LIGHT



Outdoor lighting



PS068N



Codice Prod. Item code Code Codigo Code	Alimentazione Power source Alimentation Alimentación Stromversorgung	Tecnologia della Luce Light technology Technologie de la lumière Tecnología de iluminación Beleuchtungstechnologie	Tipo di lampadina Bulb Type Type de l'ampoule Tipo de bombilla Leuchtmitteltyp	Potenza (W) Watt power Puissance Potencia Leistung	Consumo elettrico (W) Consumption Consumation Verbrauch	Lumen Lumen Lumen Lumen	Tipo di luce Kelvin degrees Degrés Kelvin Temperatura de luz °K	Materiale Material Materiau Material Material	Cavo Cable Câble Cable Kabel
PS068N	24V~9W AC/DC adaptor	LED ø5 (filament)	Papaya ø 54 mm not replaceable	0,48W / bulb	0,48W / bulb	55 Lm / bulb	3000K	Rubber	Black: 3 m + 12 m Rubber ø4.4 mm 2 x 0.2 mm <sup>2</sup>

### Descrizione / Description / Description / Descripción / Beschreibung:

Catenaria luminosa prolungabile con 20 lampadine LED  
20 LED bulbs extendable light chain  
Guirlande lumineuse prolongeable avec 20 ampoules LED  
Guirnalda luminosa extensible con 20 bombillas LED  
20 LED-Glühlampen Lichterkette, ausziehbar

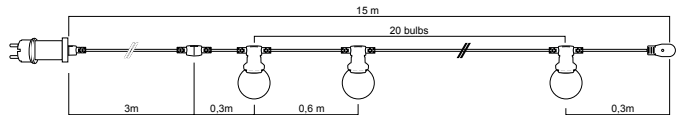

HANGABLE

Collegamenti massimi / Maximum connections / Connexions maximales

Fino a 3 catenarie dello stesso codice / Up to 3 light chains of the same code

Codice prodotto Item code Code Codigo Code	Lunghezza L1 Length Longueur Lungitud Länge	Larghezza L2 Width Largeur Ancho Breite	Altezza L3 Height Hauteur Altura Höhe	Imballo Packing Emballage Embalaje Verpackung	Inner Pces	Master Pces
PS068N	15000mm	50 mm	112 mm	Colour box	4	8

PS068N



Outdoor lighting



PS0705



Protection class

Codice Prod. Item code Code Codigo Code	Alimentazione Power source Alimentation Alimentación Stromversorgung	Tecnologia della Luce Light technology Technologie de la lumière Tecnología de iluminación Beleuchtungstechnologie	Tipo di lampadina Bulb Type Type de l'ampoule Tipo de bombilla Leuchtmitteltyp	Potenza (W) Watt power Puissance Potencia Leistung	Consumo elettrico (W) Consumption Consommation Verbrauch	Lumen Lumen Lumen Lumen	Tipo di luce Kelvin degrees Degrés Kelvin Temperatura de luz °K	Materiale Material Materiau Material Material	Cavo Cable Câble Cable Kabel
PS0705	Polycrystalline silicon solar panel: 3W 5.5V 520mA	Filament LED	S14 (ø 44 mm)	0,2W / bulb	0,2W / bulb	30 Lm / bulb	2700K	PVC + ABS	3 m + 5 m PVC ø5.2 mm 2 x 0.5 mm²

Descrizione / Description / Description / Descripción / Beschreibung:

Catenaria luminosa solare con 10 lampadine LED  
10 LED bulbs solar light chain  
Guirlande lumineuse solaire avec 10 ampoules LED  
Cadena de luz solar con 10 bombillas LED  
Solar-Lichterkette mit 10 LED-Lampen

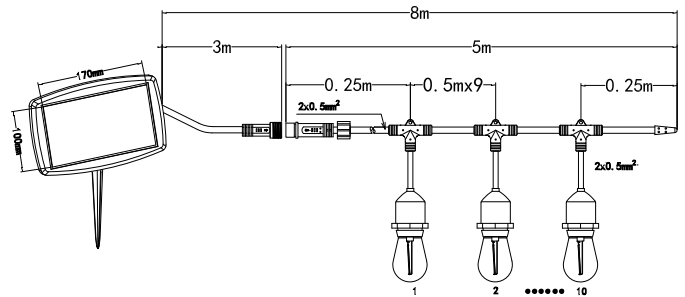

Codice prodotto Item code Code Codigo Code	Lunghezza L1 Length Longueur Lungitud Länge	Larghezza L2 Width Largeur Ancho Breite	Altezza L3 Height Hauteur Altura Höhe	Imballo Packing Emballage Embalaje Verpackung	Inner Pcs	Master Pcs
PS0705	8000mm	50 mm	112 mm	Colour box	4	8

PS0705









Outdoor lighting

CATENARIE LUMINOSE

Extendable light chains / Guirlandes lumineuses / Guiraldas luminosas / Ausziehbare Lichterkette

## PS100W

10 m

FOR  
10  
E27 BULBS  
(NOT INCLUDED)

PS100W



## PS200W

20 m

FOR  
20  
E27 BULBS  
(NOT INCLUDED)

PS200W



Codice Prod. Item code Code Codigo Code	Alimentazione Power source Alimentation Alimentación Stromversorgung	Tecnologia della Luce Light technology Technologie de la lumière Tecnología de iluminación Beleuchtungstechnologie	Materiale Material Materiau Material Material	Cavo Cable Câble Cable Kabel
<b>PS100W</b>	230V ~	10 x E27 (Bulbs not included) - LED compatible	Rubber	1,5m + 8,5 m H05RN-F2x1mm <sup>2</sup>
<b>PS200W</b>	230V ~	20 x E27 (Bulbs not included) - LED compatible	Rubber	1,5m + 18,5 m H05RN-F2x1mm <sup>2</sup>

**Descrizione / Description / Description / Descripción / Beschreibung:**

Catenaria luminosa prolungabile con 10/20 lampadine LED  
10/20 LED bulbs extendable light chain  
Guirlande lumineuse prolongeable avec 10/20 ampoules LED  
Guirnalda luminosa extensible con 10/20 bombillas LED  
10/20 LED-Glühlampen Lichterkette, ausziehbar

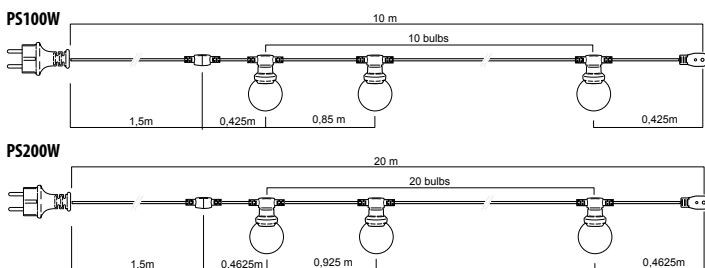

**HANGABLE**



**Collegamenti massimi / Maximum connections / Connexions maximales**

Fino a 3 catenarie dello stesso tipo / Up to 3 light chains of the same type

Codice prodotto Item code Code Codigo Code	Lunghezza L1 Length Longueur Longitud Länge	Larghezza L2 Width Largeur Ancho Breite	Altezza L3 Height Hauteur Altura Höhe	Imballo Packing Emballage Embalaje Verpackung	Inner Pces	Master Pces
<b>PS100W</b>	10000mm	44mm	63mm	White box	-	6
<b>PS200W</b>	20000mm	44mm	63mm	White box	-	6

**PS100W**



**PS200W**



# CATENARIE LUMINOSE

Extendable light chains / Guirlandes lumineuses / Guiraldas luminosas / Ausziehbare Lichterkette



## PS100B



PS100B



## PS200B



PS200B



CE celab



Codice Prod. Item code Code Codigo Code	Alimentazione Power source Alimentation Alimentación Stromversorgung	Tecnologia della Luce Light technology Technologie de la lumière Tecnología de iluminación Beleuchtungstechnologie	Materiale Material Materiau Material Material	Cavo Cable Câble Cable Kabel
PS100B	230V ~	10 x E27 (Bulbs not included) - LED compatible	Rubber	1,5m + 8,5 m H05RN-F2x1mm <sup>2</sup>
PS200B	230V ~	20 x E27 (Bulbs not included) - LED compatible	Rubber	1,5m + 18,5 m H05RN-F2x1mm <sup>2</sup>

### Descrizione / Description / Description / Descripción / Beschreibung:

Catenaria luminosa prolungabile con 10/20 lampadine LED  
10/20 LED bulbs extendable light chain  
Guirlande lumineuse prolongeable avec 10/20 ampoules LED  
Guirnalda luminosa extensible con 10/20 bombillas LED  
10/20 LED-Glühlampen Lichterkette, ausziehbar

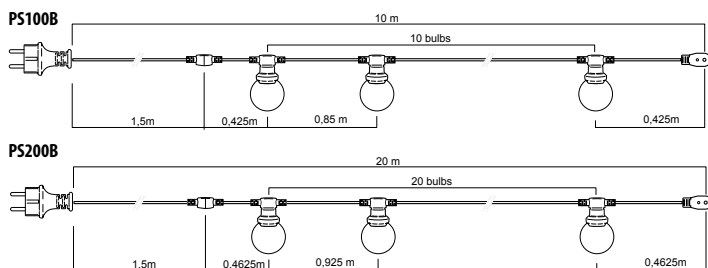

### HANGABLE



### Collegamenti massimi / Maximum connections / Connexions maximales

Fino a 3 catenarie dello stesso tipo / Up to 3 light chains of the same type

Codice prodotto Item code Code Codigo Code	Lunghezza L1 Length Longueur Lungitud Länge	Larghezza L2 Width Largeur Ancho Breite	Altezza L3 Height Hauteur Altura Höhe	Imballo Packing Emballage Embalaje Verpackung	Inner Pces	Master Pces
PS100B	10000mm	44mm	63mm	White box	-	6
PS200B	20000mm	44mm	63mm	White box	-	6

PS100B



PS200B



Outdoor lighting



PS100G



PS200G



Codice Prod. Item code Code Codigo Code	Alimentazione Power source Alimentation Alimentación Stromversorgung	Tecnologia della Luce Light technology Technologie de la lumière Tecnología de iluminación Beleuchtungstechnologie	Materiale Material Matériau Material Material	Cavo Cable Câble Cable Kabel
PS100G	230V ~	10 x E27 (Bulbs not included) - LED compatible	Rubber	1,5m + 8,5 m H05SRN-F2x1mm <sup>2</sup>
PS200G	230V ~	20 x E27 (Bulbs not included) - LED compatible	Rubber	1,5m + 18,5 m H05SRN-F2x1mm <sup>2</sup>

Descrizione / Description / Description / Descripción / Beschreibung:

Catenaria luminosa prolungabile con 10/20 lampadine LED  
 10/20 LED bulbs extendable light chain  
 Guirlande lumineuse prolongeable avec 10/20 ampoules LED  
 Guirnalda luminosa extensible con 10/20 bombillas LED  
 10/20 LED-Glühlampen Lichterkette, ausziehbar

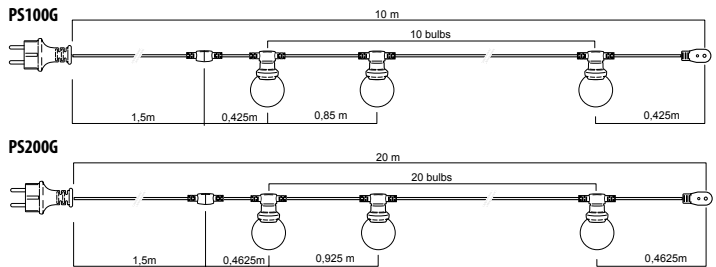

HANGABLE



Collegamenti massimi / Maximum connections / Connexions maximales

Fino a 3 catenarie dello stesso tipo / Up to 3 light chains of the same type

Codice prodotto Item code Code Codigo Code	Lunghezza L1 Length Longueur Longitud Länge	Larghezza L2 Width Largeur Ancho Breite	Altezza L3 Height Hauteur Altura Höhe	Imballo Packing Emballage Embalaje Verpackung	Inner Pces	Master Pces
PS100G	10000mm	44mm	63mm	White box	-	6
PS200G	20000mm	44mm	63mm	White box	-	6



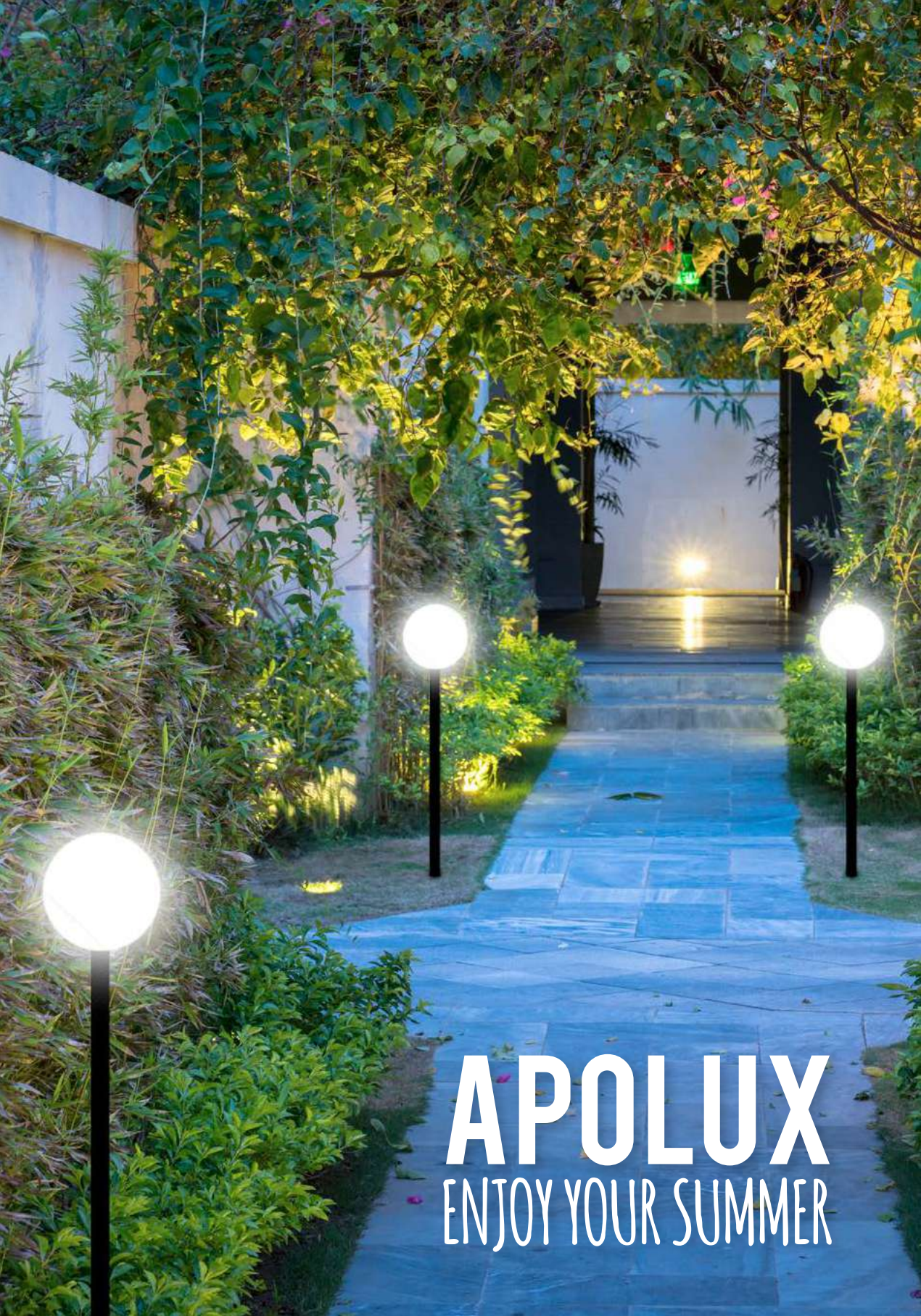

**APOLUX**  
ENJOY YOUR SUMMER



# APOLUX



Outdoor lighting



SPH200



SPH205



SPH208



Protection class



Insulation class



Codice Prodotto Item code Code Codigo Code	Alimentazione Power source Alimentation Alimentación Stromversorgung	Tecnologia della Luce Light technology Technologie de la lumière Tecnología de iluminación Beleuchtungstechnologie	Potenza (W) Watt power Puissance Potencia Leistung	Apertura Fascio Kind of beam Type de faisceau Tipo de haz Ausstrahlungswinkel	Materiale Materials Materiau Material Material
SPH200	220-240V ~ 50 Hz	E27 Lamp holder	Max 40W	360°	PMMA
SPH205	220-240V ~ 50 Hz	E27 Lamp holder	Max 40W	360°	PMMA
SPH208	220-240V ~ 50 Hz	E27 Lamp holder	Max 40W	360°	PMMA

Descrizione / Description / Description / Descripción / Beschreibung:

Accessori inclusi / Accessories included / Accessoires fournis / Accesorios incluidos / Mitgeliefertes Zubehör:

Sfera per esterno  
Outdoor globe  
Sphère d'extérieur  
Bola de exteriores  
Outdoor Lichtkugel

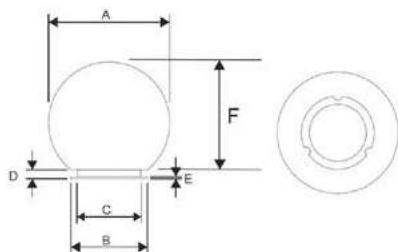

Codice Prodotto Item code Code Codigo Code	Dimensioni Dimensions // Dimensiones / Dimensions / Größe						Imballo Packing Emballage Embalaje Verpackung	Inner Pcs	Master Pcs
	A	B	C	D	E	F			
SPH200	200 mm	95 mm	91 mm	15 mm	3 mm	185 mm	Bulk	-	8
SPH205	200 mm	95 mm	91 mm	15 mm	3 mm	185 mm	Bulk	-	8
SPH208	200 mm	95 mm	91 mm	15 mm	3 mm	185 mm	Bulk	-	8

SPH200



SPH205



SPH208





# APOLUX



SPH250



SPH253



SPH254



SPH255



SPH258



Protection class



Insulation class



Codice Prodotto Item code Code Codigo Code	Alimentazione Power source Alimentation Alimentación Stromversorgung	Tecnologia della Luce Light technology Technologie de la lumière Tecnología de iluminación Beleuchtungstechnologie	Potenza (W) Watt power Puissance Potencia Leistung	Apertura Fascio Kind of beam Type de faisceau Tipo de haz Ausstrahlungswinkel	Materiale Materials Materiu Material Material
SPH250	220-240V ~ 50 Hz	E27 Lamp holder	Max 60W	360°	PMMA
SPH253	220-240V ~ 50 Hz	E27 Lamp holder	Max 60W	360°	PMMA
SPH254	220-240V ~ 50 Hz	E27 Lamp holder	Max 60W	360°	PMMA
SPH255	220-240V ~ 50 Hz	E27 Lamp holder	Max 60W	360°	PMMA
SPH258	220-240V ~ 50 Hz	E27 Lamp holder	Max 60W	360°	PMMA

Descrizione / Description / Description / Descripción / Beschreibung:

Sfera per esterno  
Outdoor globe  
Sphère d'extérieur  
Bola de exteriores  
Outdoor Lichtkugel

Accessori inclusi / Accessories included / Accessoires fournis / Accesorios incluidos / Mitgeliefertes Zubehör:

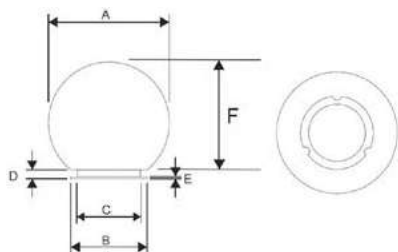

Codice Prodotto Item code Code Codigo Code	Dimensioni Dimensions / /Dimensiones / Dimensions / Größe						Imballo Packing Emballage Embalaje Verpackung	Inner Pces	Master Pces
	A	B	C	D	E	F			
SPH250	250 mm	120 mm	112 mm	13 mm	4 mm	237 mm	Bulk	-	6
SPH253	220 mm	120 mm	112 mm	15 mm	3 mm	275 mm	Bulk	-	6
SPH254	250 mm	120 mm	112 mm	13 mm	4 mm	237 mm	Bulk	-	6
SPH255	250 mm	120 mm	112 mm	13 mm	4 mm	237 mm	Bulk	-	6
SPH258	250 mm	120 mm	112 mm	13 mm	4 mm	237 mm	Bulk	-	6





# APOLUX HALF MOON



SPH307



Protection class



Insulation class



Codice Prodotto Item code Code Codigo Code	Alimentazione Power source Alimentation Alimentación Stromversorgung	Tecnologia della Luce Light technology Technologie de la lumière Tecnología de iluminación Beleuchtungstechnologie	Potenza (W) Watt power Puissance Potencia Leistung	Apertura Fascio Kind of beam Type de faisceau Tipo de haz Ausstrahlungswinkel	Materiale Materials Materiau Material Material
SPH307	220-240V ~ 50 Hz	E27 Lamp holder	Max 100W	360°	PMMA

**Descrizione** / Description / Description / Descripción / Beschreibung:

Sfera per esterno trasparente con top nero  
Transparent outdoor globe with black top  
Sphère d'extérieur transparente anti-pollution lumineuse  
Esfera para exteriores transparente con tapa negra  
Leuchtkugel für außen, transparent, mit schwarzer Spitze

**Accessori inclusi** / Accessories included / Accessoires fournis / Accesorios incluidos / Mitgeliefertes Zubehör:

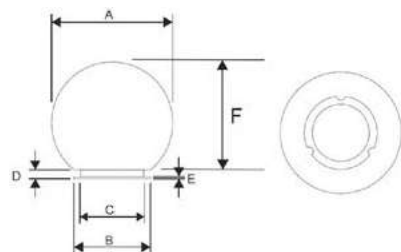

Codice Prodotto Item code Code Codigo Code	Dimensioni Dimensions / Dimensiones / Dimensions/ Größe						Imballo Packing Emballage Embalaje Verpackung	Inner Pces	Master Pces
	A	B	C	D	E	F			
SPH307	300 mm	140 mm	130 mm	15 mm	4 mm	285 mm	Bulk	4	8

SPH307







# APOLUX



SPH300



SPH304



SPH305



SPH308



Protection class



Insulation class



Codice Prodotto Item code Code Codigo Code	Alimentazione Power source Alimentation Alimentación Stromversorgung	Tecnologia della Luce Light technology Technologie de la lumière Tecnología de iluminación Beleuchtungstechnologie	Potenza (W) Watt power Puissance Potencia Leistung	Apertura Fascio Kind of beam Type de faisceau Tipo de haz Ausstrahlungswinkel	Materiale Materials Materiu Material Material
SPH300	220-240V ~ 50 Hz	E27 Lamp holder	Max 100W	360°	PMMA
SPH304	220-240V ~ 50 Hz	E27 Lamp holder	Max 100W	360°	PMMA
SPH305	220-240V ~ 50 Hz	E27 Lamp holder	Max 100W	360°	PMMA
SPH308	220-240V ~ 50 Hz	E27 Lamp holder	Max 100W	360°	PMMA

Descrizione / Description / Description / Descripción / Beschreibung:

Accessori inclusi / Accessories included / Accessoires fournis / Accesorios incluidos / Mitgeliefertes Zubehör:

Sfera per esterno  
Outdoor globe  
Sphère d'extérieur  
Bola de exteriores  
Outdoor Lichtkugel

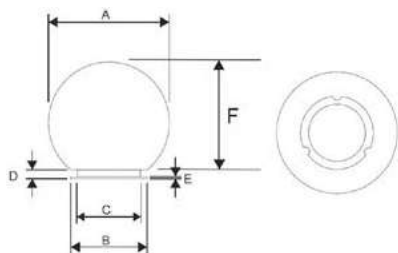

Codice Prodotto Item code Code Codigo Code	Dimensioni Dimensions / Dimensiones / Dimensions/ Größe						Imballo Packing Emballage Embalaje Verpackung	Inner Pces	Master Pces
	A	B	C	D	E	F			
SPH300	300 mm	140mm	130 mm	15 mm	3 mm	285 mm	Bulk	-	4
SPH304	300mm	140mm	130 mm	15 mm	3 mm	285 mm	Bulk	-	4
SPH305	300 mm	140mm	130 mm	15 mm	3 mm	285 mm	Bulk	-	4
SPH308	300mm	140mm	130 mm	15 mm	3 mm	285 mm	Bulk	-	4





# APOLUX - GENIUS



Outdoor lighting



Protection class



Insulation class



SPH259

Codice Prodotto Item code Code Codigo Code	Alimentazione Power source Alimentation Alimentación Stromversorgung	Tecnologia della Luce Light technology Technologie de la lumière Tecnología de iluminación Beleuchtungstechnologie	Potenza (W) Watt power Puissance Potencia Leistung	Apertura Fascio Kind of beam Type de faisceau Tipo de haz Ausstrahlungswinkel	Materiale Materials Materiau Material Material
SPH259	220-240V ~ 50 Hz	E27 Lamp holder	Max 60W	360°	PMMA

**Descrizione** / Description / Description / Descripción / Beschreibung:

Cupola trasparente per esterno  
Transparent outdoor dome  
Dôme d'extérieur transparent  
Cúpula transparente para exteriores  
Durchsichtige, kuppelförmige Leuchte

**Accessori inclusi** / Accessories included / Accessoires fournis / Accesorios incluidos / Mitgeliefertes Zubehör:

Riflettore  
Reflector  
Réflecteur  
Reflector  
Reflektor

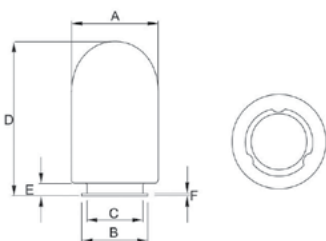

Codice Prodotto Item code Code Codigo Code	Dimensioni Dimensions / /Dimensiones / Dimensions/ Größe						Imballo Packing Emballage Embalaje Verpackung	Inner Pces	Master Pces
	A	B	C	D	E	F			
SPH259	140 mm	120 mm	112 mm	270 mm	15 mm	3 mm	Bulk	4	12

SPH259





# APOLUX



SPH400



SPH405



SPH408



Protection class



Insulation class



Codice Prodotto Item code Code Codigo Code	Alimentazione Power source Alimentation Alimentación Stromversorgung	Tecnologia della Luce Light technology Technologie de la lumière Tecnología de iluminación Beleuchtungstechnologie	Potenza (W) Watt power Puissance Potencia Leistung	Apertura Fascio Kind of beam Type de faisceau Tipo de haz Ausstrahlungswinkel	Materiale Materials Materiu Material Material
SPH400	220-240V ~ 50 Hz	E27 Lamp holder	Max 100W	360°	PMMA
SPH405	220-240V ~ 50 Hz	E27 Lamp holder	Max 100W	360°	PMMA
SPH408	220-240V ~ 50 Hz	E27 Lamp holder	Max 100W	360°	PMMA

Descrizione / Description / Description / Descripción / Beschreibung:

Accessori inclusi / Accessories included / Accessoires fournis / Accesorios incluidos / Mitgeliefertes Zubehör:

Sfera per esterno  
Outdoor globe  
Sphère d'extérieur  
Bola de exteriores  
Outdoor Lichtkugel

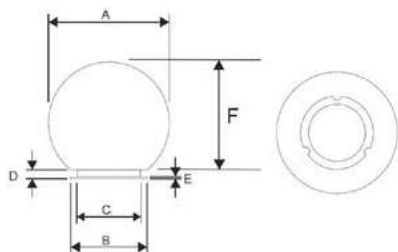

Codice Prodotto Item code Code Codigo Code	Dimensioni Dimensions / Dimensiones / Dimensions/ Größe						Imballo Packing Emballage Embalaje Verpackung	Inner Pces	Master Pces
	A	B	C	D	E	F			
SPH400	400mm	150mm	140mm	15mm	5mm	385mm	Bulk	-	2
SPH405	400mm	150mm	140mm	15mm	5mm	385mm	Bulk	-	2
SPH408	400mm	150mm	140mm	15mm	5mm	385mm	Bulk	-	2





## ACCESSORI APOLUX

Accessori compatibili - Compatible accessories - Accessoires compatibles - Accesorios compatibles - Kompatibles Zubehör

Outdoor lighting

Foto	Codice Item code Code Codigo Code	Descrizione	Dimensioni Dimensions Dimensions Dimensiones Abmessungen	Materiale Material Materiau Material Material	Imballo Packing Emballage Embalaje Verpackung	Inner Pces	Master Pces	Codice ean Ean code Ean code Ean code Ean code
	SPH140	Base corta Short stand Petite base Base corta Kurzer Stand	12 cm (H)	ABS	Bulk	10	50	 8 003910 106352 >
	SPH142	Base lunga Long stand Grande base Base larga Langer Stand	18 cm (H)	ABS	Bulk	10	50	 8 003910 106369 >
	SPH150	Braccio corto Short arm Bras court Brazo corto <b>Only for globes with ø 200, 250, 300 mm</b>	23 cm (W)	ABS	Bulk	10	50	 8 003910 106376 >
	SPH152	Braccio lungo Long arm Bras long Brazo largo Kurzer Arm <b>Only for globes with ø 350, 400 mm</b>	31 cm (W)	ABS	Bulk	10	50	 8 003910 106468 >
	SPH105	Palo 0,5m 0,5m pole Mât 0,5m Barra 0,5 m Stange 0,5m	ø 6cm	ABS	Bulk	-	12	 8 003910 106383 >
	SPH110	Palo 1m 1m pole Mât 1m Barra 1m Stange 1m	ø 6cm	ABS	Bulk	-	12	 8 003910 106390 >
	SPH115	Palo 1,5m 1,5m pole Mât 1,5m Barra 1,5 m Stange 1,5m	ø 6cm	ABS	Bulk	-	4	 8 003910 106406 >
	SPH120	Palo 2m 2m pole Mât 2m Barra 2m Stange 2m	ø 6cm	ABS	Bulk	-	4	 8 003910 106413 >
	<b>NEW</b>	SPH124	Palo 2,4m 2,4m pole Mât 2,4m Barra 2,4m Stange 2,4m	ø 6cm	ABS	Bulk	-	4
	SPH162	Base da pavimento Floor base Base de fixation au sol Base de suelo Bodenplatte	ø 16,5 cm	ABS	Bulk	6	36	 8 003910 106437 >
	SPH182	Testa palo per fissaggio 2 sfere 2 heads connector	86 x 100 x 110 mm	ABS	Bulk	-	1	 8 003910 108349 >
	SPH183	Testa palo per fissaggio 3 sfere 3 heads connector	ø125 mm h: 100 mm	ABS	Bulk	-	1	 8 003910 108356 >



# COMBINAZIONI APOLUX

## 1 Choose your globe diameter:

ø 200 mm



ø 250 mm



ø 300 mm



ø 400 mm

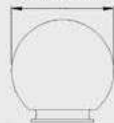

## 2 Choose the colour of your globe:

transparent



white



frosted white



smoked



## 3 Choose installation:

on pole:



+



choose the pole length:  
0,5m / 1m / 1,5m / 2m / 2,4 m

**SPH162 base**

If you want to install 2 globes



+



OR



you must use the **SPH182 connector**

**SPH150**  
for globes  
200 / 250 / 300mm

**SPH152**  
for globes  
400mm

If you want to install 3 globes



+



OR



you must use the **SPH183 connector**

**SPH150**  
for globes  
200 / 250 / 300mm

**SPH152**  
for globes  
400mm

on wall:



OR



**SPH150**  
for globes  
200 / 250 / 300mm

**SPH152**  
for globes  
400mm

on stand:



OR



Short base: **SPH140**

Long base **SPH142**



# APOLUX

Outdoor lighting



SPH202P



SPH206P



SPH209P



Protection class



Insulation class



Codice Prodotto Item code Code Codigo Code	Alimentazione Power source Alimentation Alimentación Stromversorgung	Tecnologia della Luce Light technology Technologie de la lumière Tecnología de iluminación Beleuchtungstechnologie	Potenza (W) Watt power Puissance Potencia Leistung	Apertura Fascio Kind of beam Type de faisceau Tipo de haz Ausstrahlungswinkel	Materiale Materials Materiau Material Material
SPH202P	220-240V ~ 50 Hz	E27 Lamp holder	Max 40W	360°	PMMA
SPH206P	220-240V ~ 50 Hz	E27 Lamp holder	Max 40W	360°	PMMA
SPH209P	220-240V ~ 50 Hz	E27 Lamp holder	Max 40W	360°	PMMA

**Descrizione** / Description / Description / Descripción / Beschreibung:

Applique sphérique  
Outdoor globe with bracket  
Applique sphérique d'extérieur  
Applique esférica de exteriores  
Outdoor Lichtkugel mit Halterung

**Accessori inclusi** / Accessories included / Accessoires fournis / Accesorios incluidos / Mitgeliefertes Zubehör:

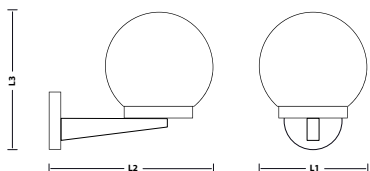

Codice Prodotto Item code Code Codigo Code	Lunghezza L1 Length Longueur Lungitud Länge	Larghezza L2 Width Largeur Ancho Breite	Altezza L3 Height Hauteur Altura Höhe	Imballo Packing Emballage Embalaje Verpackung	Inner Pcs	Master Pcs
SPH202P	200 mm	265 mm	245 mm	White Box	-	6
SPH206P	200 mm	265 mm	245 mm	Bulk	-	6
SPH209P	200 mm	265 mm	245 mm	Bulk	-	6

SPH202P



SPH206P



SPH209P



# SOLARE & AUTONOMO

Solar lighting / Eclairage solaire / Iluminacion con carga solar / Solarbeleuchtung

## SL210 - DORY

Applique LED a carica solare con rilevatore di movimento

Solar motion welcome light

Applique solaire LED avec détecteur de mouvements

Aplica solar LED con detector de movimientos

Solar LED-Leuchte mit Bewegungsmelder



SL210



COD.									+	Packing	Inner Pces	Master Pces
SL210	0,8W SMD LED	40 Lm	15 hrs	Diffuse Light	86 x 41 x 114 mm	Lithium 3.7V 600mAh (included)	Monocrystalline solar panel: 0.6W 5V 120mA	ABS+PS	Double sided sticker + 2 screws	Blister F4	6	24



Outdoor lighting

## SL235 - ARMOUR

Applique LED a carica solare con rilevatore di movimento

Solar charged LED wall lamp with motion sensor

Applique solaire LED avec détecteur de mouvements

Lámpara de pared LED con carga solar y sensor de movimiento

LED Solar Wandleuchte mit Bewegungsmelder



SL235



COD.									+	Packing	Inner Pces	Master Pces
SL235	3 SMD LED 2,2W	220 Lm	6 hrs	Diffuse Light	205 x 200 x 95 mm	3x AA Ni-MH 600mAh (included)	Monocrystalline solar panel: 5,5V 110mA	Plastic + Steel	2 screws	Colour box	6	12

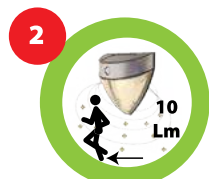



**NEW**



### SL237 - COLOMBA

Applique LED a carica solare con rilevatore di movimento  
*Solar motion welcome light*  
 Applique solaire LED avec détecteur de mouvements  
 Aplica solar LED con detector de movimientos  
 Solar LED-Leuchte mit Bewegungsmelder



SL237



COD.									+	Packing	Inner Pcs	Master Pcs
SL237	4W S4+2 SMD LED	500 Lm	Up to 35 hours (300 on / off cycles)	Diffuse Light 90°	140 x 115 x 211 mm	Lithium 3.7V 2000mAh (type 18650) (included)	Monocrystalline solar panel: 5,5V 2,4W	ABS+PC (UV resistant)	2 screws + 2 plastic dowels	Colour box	4	16

### SL238 - TECNO

Applique LED a carica solare con rilevatore di movimento  
*Solar motion welcome light*  
 Applique solaire LED avec détecteur de mouvements  
 Aplica solar LED con detector de movimientos  
 Solar LED-Leuchte mit Bewegungsmelder



**3 MODES:**

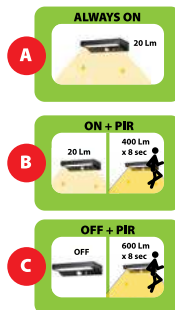

SL238



COD.									+	Packing	Inner Pcs	Master Pcs
SL238	6W SMD LED 2835	600 Lm	8 hrs	Diffuse Light	205 x 106 x 40 mm	Lithium 3.7V 2200mAh (type 18650) (included)	Monocrystalline solar panel: 6W / 1.8W / 0.3A	ABS+PC	2 screws	Colour box	6	24



# SOLARE & AUTONOMO

Solar lighting / Éclairage solaire / Iluminación con carga solar / Solarbeleuchtung

## SL420 - MALIS XL

Lampada solare da terra per esterno con rilevatore di movimento  
 LED solar garden light with motion sensor  
 Lampe de jardin LED solaire sur pied avec détecteur de mouvements  
 LED luz de jardín solar con sensor de movimiento  
 LED Solar Gartenleuchte mit Bewegungsmelder



GARDEN SPIKE  
(INCLUDED)



SL420



COD.									Packing	Inner Pces	Master Pces
SL420	3 SMD LED 2,2W	220 Lm	6 hrs	Diffuse Light	3.7V 1200mAh 18650 Li-ion type (included)	Monocrystalline solar panel: 5.5V 90mA	Steel + Plastic	2 screws + spike	Colour box	-	6





### SL330 - DEVILS

Appliche LED a carica solare con rilevatore di movimento  
 Solar charged LED wall lamp with motion sensor  
 Applique solaire LED avec détecteur de mouvements  
 Lámpara de pared LED con carga solar y sensor de movimiento  
 LED Solar Wandleuchte mit Bewegungsmelder



**3 MODES:**

**ALWAYS ON**



**ON + PIR**



**OFF + PIR**



SL330



COD.								+	Packing	Inner Pcs	Master Pcs
SL330	SMD LED	600 Lm	8 hrs	Diffuse Light	3.7V 2200mAh 18650 Li-ion (18650 type) (included)	6V 0.3A Monocrystalline solar panel	Steel + PC	2 screws	Colour box	-	6

### SL340 - DEVILS TOWER

Lampada solare da terra per esterno con rilevatore di movimento  
 LED solar garden light with motion sensor  
 Lampe de jardin LED solaire sur pied avec détecteur de mouvements  
 LED luz de jardín solar con sensor de movimiento  
 LED Solar Gartenleuchte mit Bewegungsmelder



GARDEN SPIKE (INCLUDED)

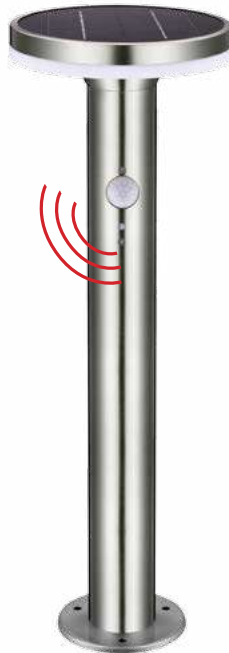

**3 MODES:**



SL340



COD.								+	Packing	Inner Pcs	Master Pcs
SL340	SMD LED	600 Lm	8 hrs	Diffuse Light	3.7V 2200mAh 18650 Li-ion (18650 type) (included)	6V 0.3A Monocrystalline solar panel	Steel + PC	2 screws + spike	Colour box	-	6

# SOLARE & AUTONOMO

Solar lighting / Éclairage solaire / Iluminación con carga solar / Solarbeleuchtung

## SL344 - TULUM

Lampada solare da terra per esterno con rilevatore di movimento  
 LED solar garden light with motion sensor  
 Lampe de jardin LED solaire sur pied avec détecteur de mouvements  
 LED luz de jardín solar con sensor de movimien  
 LED Solar Gartenleuchte mit Bewegungsmelder



GARDEN SPIKE  
(INCLUDED)



ø 16 cm



54 cm



### 3 MODES:



SL344



COD.	💡	🔦	🕒	☀️	🔋	🔌	🏠	+	Packing	Inner Pces	Master Pces
<b>SL344</b>	6W SMD LED 2835	600 Lm	8 hrs	Diffuse Light	Lithium 3.7V 2200mAh (type 18650) (included)	Monocrystalline solar panel: 6W / 1.8W / 0.3A	Steel + PC	3 x screws + spike	Colour box	-	4



# IS352 - FROG



IS352



Protection class



Codice Prodotto Item code Code Codigo Code	Alimentazione Power source Alimentation Alimentación Stromversorgung	Tecnologia della Luce Light technology Technologie de la lumière Tecnología de iluminación Beleuchtungstechnologie	Potenza (W) Watt power Puissance Potencia Leistung	Lumen Lumen Lumen Lumen	Tipo di luce Kelvin degrees Degrés Kelvin Temperatura de luz °K	Materiale Material Materiau Material Material	Apertura Fascio Kind of beam Type de faisceau Tipo de haz Ausstrahlungswinkel
IS352	Dry Batteries: 4 x C / LR14 (not included)	2 x CREE® LED	2 x 5W	450 Lm	6000K	ABS	Focus Light

**Descrizione** / Description / Description / Descripción / Beschreibung:

Faro LED a pile con rilevatore di movimento  
 Dry battery operated LED spotlight with motion sensor  
 Projecteur LED à piles avec détecteur de mouvements  
 Proyector LED con sensor de movimiento con pilas  
 Scheinwerfer LED batteriegeladen, mit Bewegungsmelder<

<b>Angolo di rilevazione</b> / Degrees motion sensor/ Angle / Grados de sensor / Erfassungswinkel	140°
<b>Tempo di funzionamento</b> / Working time / Temps de fonctionnement / Tiempo de funcionamiento / Betriebszeit	from 5 sec up to 7 min approx

Codice prodotto Item code Code Codigo Code	Lunghezza L1 Length Longueur Longitud Länge	Larghezza L2 Width Largeur Ancho Breite	Altezza L3 Height Hauteur Altura Höhe	Imballo Packing Emballage Embalaje Verpackung	Inner Pces	Master Pces
IS352	138 mm	169 mm	116 mm	Colour box	-	6

IS352



# IS342 - INCA



Outdoor lighting



IS342



Protection class

Codice Prodotto Item code Code Codigo Code	Alimentazione Power source Alimentation Alimentación Stromversorgung	Tecnologia della Luce Light technology Technologie de la lumière Tecnología de iluminación Beleuchtungstechnologie	Potenza (W) Watt power Puissance Potencia Leistung	Lumen Lumen Lumen Lumen	Autonomia Runtime Autonomie Autonomía Autonomie	Materiale Material Materiau Material Material	Apertura Fascio Kind of beam Type de faisceau Tipo de haz Ausstrahlungswinkel	Cavo Cable Câble Cable Kabel
IS342	1W Amorphous solar panel Battery: Li-ion 3,7V 1200mAh type 18650 (included) Replaceable	LED COB 10W	10W	1600 Lm	50 min (Continuous use)	ABS+PC	Diffuse Light 120°	3,7 m

**Descrizione / Description / Description / Descripción / Beschreibung:**

Faro LED a carica solare con rilevatore di movimento  
Solar charged LED floodlight with motion sensor  
Projecteur solaire LED avec détecteur de mouvements  
Projector LED solar con sensor de movimiento  
Solar LED-Scheinwerfer mit Bewegungsmelder

**Accessori inclusi / Accessories included / Accessoires fournis / Accesorios incluidos / Mitgeliefertes Zubehör:**

**Connection cable:**  
3,7m



**USB cable: 1 mt**



<b>Angolo di rilevazione / Degrees motion sensor / Angle / Grados de sensor / Erfassungswinkel</b>	120°
<b>Tempo di funzionamento / Working time / Temps de fonctionnement / Tiempo de funcionamiento / Betriebszeit</b>	25 sec



**Il proiettore può essere utilizzato con un caricabatterie da 5V AC/DC (non incluso)**

The floodlight can be used with a 5V AC/DC charger (not included)

Codice prodotto Item code Code Codigo Code	Lunghezza L1 Length Longueur Lungitud Länge	Larghezza L2 Width Largeur Ancho Breite	Altezza L3 Height Hauteur Altura Höhe	Imballo Packing Emballage Embalaje Verpackung	Inner Pcs	Master Pcs
IS342 Floodlight: Panel:	154 mm 210 mm	90 mm 15 mm	160 mm 150 mm	Colour box	-	4

IS342





Outdoor lighting



NEW

HAWK



SL360



Protection class

Codice Prod. Item code Code Codigo Code	Alimentazione Power source Alimentación Alimentación Stromversorgung	Tecnologia della Luce Light technology Technologie de la lumière Tecnología de iluminación Beleuchtungstechnologie	Potenza (W) Watt power Puissance Potencia Leistung	Lumen Lumen Lumen Lumen	Tipo di luce Kelvin degrees Degrés Kelvin Temperatura de luz °K	Batteria Battery Batterie Batería Batterie	Autonomia Runtime Autonomie Autonomia Autonomie	Materiale Material Materiau Material Material	Apertura Fascio Kind of beam Type de faisceau Tipo de haz Ausstrahlungswinkel
SL360	5,5V 2,3W Monocrystalline solar panel	30 SMD LED	5W	500 Lm	4000K	3,7V 3000mAh Li-ion (18650 Replaceable)	- Sensor mode: up to 5 nights - Continuous light mode: 5 hours	ABS+PC + Aluminium	Diffuse 120°

Descrizione / Description / Description / Descripción / Beschreibung:

Proiettore LED solare 5W  
5W Solar LED Flood Light  
Projecteur LED solaire 5W  
5W Projector LED solar 5W  
5W Solar-LED-Flutlicht

Accessori inclusi / Accessories included / Accessoires fournis / Accesorios incluidos / Mitgeliefertes Zubehör:

2 tasselli di plastica + 2 viti  
2 plastic dowels + 2 screws

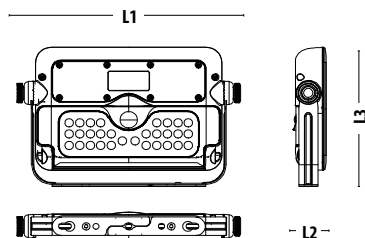

Angolo di rilevazione / Degrees motion sensor / Angle / Grados de sensor / Erfassungswinkel	120°
Raggio d'azione / Detection range / Rayon d'action / Rayo de accion / Reichweite	< 6 m
Tempo di funzionamento / Working time / Temps de fonctionnement / Tiempo de funcionamiento / Betriebszeit	20 sec.
Altezza di installazione / Installation height	< 4 m

Codice prodotto Item code Code Codigo Code	Lunghezza L1 Length Longueur Lungitud Länge	Larghezza L2 Width Largeur Ancho Breite	Altezza L3 Height Hauteur Altura Höhe	Imballo Packing Emballage Embalaje Verpackung	Inner Pcs	Master Pcs
SL360	231,9 mm	149,6 mm	33,7 mm	Colour box	4	16

SL360



# HAWK XL



**NEW**



Outdoor lighting



SL362



Protection class	1150 LUMEN	LONG RUN TIME	IP65	CE	SL362	QR	VELAMP	1150 LUMEN	LONG RUN TIME	1150 LUMEN
<b>Codice Prod.</b> Item code Code Codigo Code	<b>Alimentazione</b> Power source Alimentation Alimentación Stromversorgung	<b>Tecnologia della Luce</b> Light technology Technologie de la lumière Tecnología de iluminación Beleuchtungstechnologie	<b>Potenza (W)</b> Watt power Puissance Potencia Leistung	<b>Lumen</b> Lumen Lumen Lumen Lumen	<b>Tipo di luce</b> Kelvin degrees Degrés Kelvin Temperatura de luz °K	<b>Batteria</b> Battery Batterie Batería Batterie	<b>Autonomia</b> Runtime Autonomie Autonomia Autonomie	<b>Materiale</b> Material Materiau Material Material	<b>Apertura Fascio</b> Kind of beam Type de faisceau Tipo de haz Ausstrahlungswinkel	
SL362	6W Monocrystalline solar panel	64 SMD LED	10W	1150 Lm	4000K	7.4V 3000mAh Li-ion (18650 Replaceable)	Sensor mode: up to 5 nights Continuous light mode: 6 hours	ABS+PC +Aluminium	Diffuse 120°	

**Descrizione / Description / Description / Descripción / Beschreibung:**

Proiettore LED solare 10W  
10W Solar LED Flood Light  
Projecteur LED solaire 10W  
5W Projector LED solar 10W  
10W Solar-LED-Flutlicht

**Accessori inclusi / Accessories included / Accessoires fournis / Accesorios incluidos / Mitgeliefertes Zubehör:**

**2 tasselli di plastica + 2 viti**  
**+ 1 chiave a brugola + 1 Zanca ad U**  
2 plastic dowels + 2 screws  
+ 1 Allen wrench + 1 U-Shaped bracket



L1

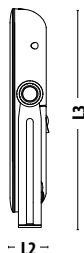
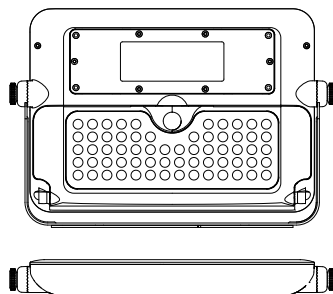

<b>Angolo di rilevazione / Degrees motion sensor / Angle / Grados de sensor / Erfassungswinkel</b>	120°
<b>Raggio d'azione / Detection range / Rayon d'action / Rayo de accion / Reichweite</b>	< 8 m
<b>Tempo di funzionamento / Working time / Temps de fonctionnement / Tiempo de funcionamiento / Betriebszeit</b>	20 sec.
<b>Altezza di installazione / Installation height</b>	< 4 m

Codice prodotto Item code Code Codigo Code	Lunghezza L1 Length Longueur Lungitud Länge	Larghezza L2 Width Largeur Ancho Breite	Altezza L3 Height Hauteur Altura Höhe	Imballo Packing Emballage Embalaje Verpackung	Inner Pces	Master Pces
SL362	313.9 mm	211.3 mm	37.4 mm	Colour box	1	8

SL362





CRUISER



NEW



SL373



Protection class

Codice Prod. Item code Code Codigo Code	Alimentazione Power source Alimentación Alimentación Stromversorgung	Tecnologia della Luce Light technology Technologie de la lumière Tecnología de iluminación Beleuchtungstechnologie	Potenza (W) Watt power Puissance Potencia Leistung	Lumen Lumen Lumen Lumen Lumen	Tipo di luce Kelvin degrees Degrés Kelvin Temperatura de luz °K	Batteria Battery Batterie Bateria Batterie	Autonomia Runtime Autonomie Autonomia Autonomie	Materiale Material Materiiau Material Material	Apertura Fascio Kind of beam Type de faisceau Tipo de haz Ausstrahlungswinkel
SL373	9.5W Monocrystalline solar panel	40 SMD LED	15W	1600 Lm	4000K	7,4V 5400mAh Li-ion (replaciale)	Up to 5 nights (full charge, automatic light adjustment mode)	ABS+PC +Aluminium	Diffuse 120°

Descrizione / Description / Description / Descripción / Beschreibung:

Lampione 15W LED solare con sensore di movimento  
15W Solar LED light with PIR motion sensor  
Réverbère solaire LED 15W avec détecteur de mouvements  
Farola LED solar 15W con sensor de movimiento PIR  
15W Solar-LED-Straßenlaterne mit Bewegungssensor

Accessori inclusi / Accessories included / Accessoires fournis / Accesorios incluidos / Mitgeliefertes Zubehör:

- 2 zanche per montaggio su palo dritto.
- 1 zanca per montaggio su palo curvo.
- Viti, tasselli e chiave a brugola.
- 2 mounting brackets on straight pole.
- 1 mounting bracket on curved pole.
- Screws, dowels and Allen wrench.



Angolo di rilevazione / Degrees motion sensor / Angle / Grados de sensor / Erfassungswinkel	120°
Raggio d'azione / Detection range / Rayon d'action / Rayo de accion / Reichweite	< 6 m
Tempo di funzionamento / Working time / Temps de fonctionnement / Tiempo de funcionamiento / Betriebszeit	20 sec.

Modalità di installazione / Installationn way



Codice prodotto Item code Code Codigo Code	Lunghezza L1 Length Longueur Lungitud Länge	Larghezza L2 Width Largeur Ancho Breite	Altezza L3 Height Hauteur Altura Höhe	Imballo Packing Emballage Embalaje Verpackung	Inner Pces	Master Pces
SL373	492,5 mm	231,9 mm	58 mm	Colour box	1	8

SL373







## SOLAR NOVA

## SOLAR NOVA XL



SL528



SL532



Protection class



RGB



Codice Prod. Item code Code Codigo Code	Alimentazione Power source Alimentation Alimentación Stromversorgung	Tecnologia della Luce Light technology Technologie de la lumière Tecnología de iluminación Beleuchtungstechnologie	Potenza (W) Watt power Puissance Potencia Leistung	Lumen Lumen Lumen Lumen	Tipo di luce Kelvin degrees Degrés Kelvin Temperatura de luz °K	Batteria Battery Batterie Batería Batterie	Autonomia Runtime Autonomie Autonomía Autonomía	Materiale Material Materiau Material Material	Apertura Fascio Kind of beam Type de faisceau Tipo de haz Ausstrahlungswinkel
SL528	6V 1W Monocrystalline solar panel	2 x 5050 RGBW LED	0.4W	30 Lm	3000K (White) + RGB (7 colours)	3,7V 1200mAh Li-ion	6 hrs (when fully charged)	PE	Diffuse 270°
SL532	6V 1W Monocrystalline solar panel	2 x 5050 RGBW LED	0.4W	30 Lm	3000K (White) + RGB (7 colours)	3,7V 1200mAh Li-ion	6hrs (when fully charged)	PE	Diffuse 270°

Descrizione / Description / Description / Descripción / Beschreibung:

Accessori inclusi / Accessories included / Accessoires fournis / Accesorios incluidos / Mitgeliefertes Zubehör:

Sfera luminosa solare LED RGB  
RGB LED solar garden ball  
Sphère solaire LED RGB  
Solar LED-RGB-Lichtkugel  
Bola de led luminosa solar RGB



Telecomando  
Remote control  
(1 x CR2025 batteria inclusa / battery included)



Picchetto da giardino  
Ground spike



Codice prodotto Item code Code Codigo Code	Lunghezza L1 Length Longueur Longitud Länge	Larghezza L2 Width Largeur Ancho Breite	Altezza L3 Height Hauteur Altura Höhe	Imballo Packing Emballage Embalaje Verpackung	Inner Pcs	Master Pcs
SL528	250 mm	250 mm	250 mm	White box	-	4
SL532	300 mm	300 mm	300 mm	White box	-	2

SL528



SL532





Outdoor lighting

# SOLAR STONE



**REMOTE CONTROL (included)**



SL561



RGB



Protection class



Codice Prod. Item code Code Codigo Code	Alimentazione Power source Alimentation Alimentación Stromversorgung	Tecnologia della Luce Light technology Technologie de la lumière Tecnología de iluminación Beleuchtungstechnologie	Potenza (W) Watt power Puissance Potencia Leistung	Lumen Lumen Lumen Lumen	Tipo di luce Kelvin degrees Degrés Kelvin Temperatura de luz °K	Batteria Battery Batterie Bateria Batterie	Autonomia Runtime Autonomie Autonomía Autonomía	Materiale Material Materiiau Material Material	Apertura Fascio Kind of beam Type de faisceau Tipo de haz Ausstrahlungswinkel
SL561	6V 1,5W Monocrystalline solar panel	4 x 5050 RGBW LED	0.8W	30 Lm	3000K (White) + RGB (7 colours)	3,7V 1200mAh Li-ion	6 hrs (when fully charged)	PE	Diffuse 270°

**Descrizione / Description / Description / Descripción / Beschreibung:**

Sasso luminoso solare LED  
Solar LED stone  
Pierre solaire LED  
Piedra luminosa LED solar  
LED Solar-Lichtstein

**Accessori inclusi / Accessories included / Accessoires fournis / Accesorios incluidos / Mitgeliefertes Zubehör:**



**Telecomando**  
Remote control  
(1 x CR2025 batteria inclusa / battery included)



**Picchetto da giardino**  
Ground spike



Codice prodotto Item code Code Codigo Code	Lunghezza L1 Length Longueur Lungitud Länge	Larghezza L2 Width Largeur Ancho Breite	Altezza L3 Height Hauteur Altura Höhe	Imballo Packing Emballage Embalaje Verpackung	Inner Pces	Master Pces
SL561	400 mm	300 mm	150 mm	White box	-	2

SL561



# ABAT-JOUR



**NEW**



Protection class



SL2048



Codice Prod. Item code Code Codigo Code	Alimentazione Power source Alimentation Alimentación Stromversorgung	Tecnologia della Luce Light technology Technologie de la lumière Tecnología de iluminación Beleuchtungstechnologie	Potenza (W) Watt power Puissance Potencia Leistung	Lumen Lumen Lumen Lumen Lumen	Tipo di luce Kelvin degrees Degrés Kelvin Temperatura de luz °K	Batteria Battery Batterie Batería Batterie	Autonomia Runtime Autonomie Autonomía Autonomie	Materiale Material Materiau Material Material	Apertura Fascio Kind of beam Type de faisceau Tipo de haz Ausstrahlungswinkel
SL2048	5V 180mA Monocrystalline solar panel	SMD LED	5W	15 Lm 200 Lm	(11 LED da 0.2W) 2200K (10 LED da 0.5W) 4000K	3,7V 1800mAh Li-ion (18650 replaceable)	2 hrs	Aluminium + ABS + PC	Diffuse

**Descrizione** / Description / Description / Descripción / Beschreibung:

**Accessori inclusi** / Accessories included / Accessoires fournis / Accesorios incluidos / Mitgeliefertes Zubehör:

Lampada da tavolo solare LED  
Solar LED table lamp  
Lampe solaire LED de table  
Lámpara de mesa LED solar  
LED Solar-Tischlampe

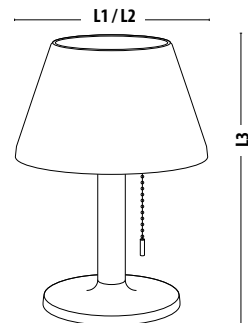

Codice prodotto Item code Code Codigo Code	Lunghezza L1 Length Longueur Lungitud Länge	Larghezza L2 Width Largeur Ancho Breite	Altezza L3 Height Hauteur Altura Höhe	Imballo Packing Emballage Embalaje Verpackung	Inner Pcs	Master Pcs
SL2048	200 mm	200 mm	280 mm	Colour box	-	4

SL2048





Outdoor lighting

SOLARE & AUTONOMO

Solar lighting / Éclairage solaire / Iluminación con carga solar / Solarbeleuchtung

# MINI EXTENZA SOLAR



SL2044



REMOTE CONTROL (included)



Protection class



RGB

Codice Prod.	Alimentazione	Tecnologia della Luce	Potenza (W)	Lumen	Tipo di luce	Batteria	Autonomia	Materiale	Apertura Fascio
Item code Code Codigo Code	Power source Alimentation Alimentación Stromversorgung	Light technology Technologie de la lumière Tecnología de iluminación Beleuchtungstechnologie	Watt power Puissance Potencia Leistung	Lumen Lumen Lumen Lumen	Kelvin degrees Degrés Kelvin Temperatura de luz °K	Battery Batterie Bateria Batterie	Runtime Autonomie Autonomia Autonomie	Material Materiau Material Material	Kind of beam Type de faisceau Tipo de haz Ausstrahlungswinkel
SL2044	6V 1W Monocrystalline solar panel	3 x 5050 RGB LED + 3 x 2835 White LED	0.6W	30 Lm	3000K (White) + RGB (7 colours)	3,7V 1200mAh Li-ion	6 hrs (when fully charged)	PE	Diffuse 270°

Descrizione / Description / Description / Descripción / Beschreibung:

Lampada da tavolo solare LED  
Solar LED table lamp  
Lampe solaire LED de table  
Lámpara de mesa LED solar  
LED Solar-Tischlampe

Accessori inclusi / Accessories included / Accessoires fournis / Accesorios incluidos / Mitgeliefertes Zubehör:



Telecomando  
Remote control  
(1 x CR2025 batteria inclusa / battery included)



Cavo USB  
Usb cable



Codice prodotto	Lunghezza L1	Larghezza L2	Altezza L3	Imballo	Inner Pces	Master Pces
Item code Code Codigo Code	Length Longueur Lungitud Länge	Width Largeur Ancho Breite	Height Hauteur Altura Höhe	Packing Emballage Embalaje Verpackung		
SL2044	200	200	360	White box	-	2

SL2044



# EXTENZA SOLAR



SL3432



Outdoor lighting



RGB



Protection class

Codice Prod. Item code Code Codigo Code	Alimentazione Power source Alimentation Alimentación Stromversorgung	Tecnologia della Luce Light technology Technologie de la lumière Tecnología de iluminación Beleuchtungstechnologie	Potenza (W) Watt power Puissance Potencia Leistung	Lumen Lumen Lumen Lumen Lumen	Tipo di luce Kelvin degrees Degrés Kelvin Temperatura de luz °K	Batteria Battery Batterie Batería Batterie	Autonomia Runtime Autonomie Autonomía Autonomie	Materiale Material Materiau Material Material	Apertura Fascio Kind of beam Type de faisceau Tipo de haz Ausstrahlungswinkel
SL3432	6V 1.5W Monocrystalline solar panel	6 x 5050 RGB LED + 15 x 2835 White LED	3W	White 1° step: 100 Lm White 2° step: 200 Lm White 3° step: 300 Lm	3000K (White) + RGB (7 colours)	3,7V 1800mAh Li-ion	8 hrs (Sunny days) 12 hrs (Rainy day, winter) 4 hrs (USB charge)	PE+Steel	Diffuse 270°

Descrizione / Description / Description / Descripción / Beschreibung:

Lampada da terra solare LED per esterni  
Outdoor LED solar floor lamp  
Lampadaire LED solaire  
Lámpara de pie LED solar para uso exterior  
LED Solar-Stehlampe für den Aussenbereich



Accessori inclusi / Accessories included / Accessoires fournis / Accesorios incluidos / Mitgeliefertes Zubehör:



**Telecomando**  
Remote control  
(1 x CR2025 batteria inclusa  
/ battery included)



**Cable USB**  
USB cable:  
2m

Codice prodotto Item code Code Codigo Code	Lunghezza L1 Length Longueur Lungitud Länge	Larghezza L2 Width Largeur Ancho Breite	Altezza L3 Height Hauteur Altura Höhe	Imballo Packing Emballage Embalaje Verpackung	Inner Pces	Master Pces
SL3432	240 mm	340 mm	1500 mm	White box	-	1

SL3432



## TL3430 - EXTENZA

Outdoor lighting



Protection class



Insulation class



TL3430



Codice Prodotto Item code Code Codigo Code	Alimentazione Power source Alimentation Alimentación Stromversorgung	Tecnologia della Luce Light technology Technologie de la lumière Tecnología de iluminación Beleuchtungstechnologie	Potenza (W) Watt power Puissance Potencia Leistung	Apertura Fascio Kind of beam Type de faisceau Tipo de haz Ausstrahlungswinkel	Materiale Material Material Material Material
TL3430	220-240V ~ 50 Hz	E27 Lamp holder (Bulb not included) - LED compatible	Max 15W LED	360°	PE

Descrizione / Description / Description / Descripción / Beschreibung:

Lampada da terra per esterni  
Outdoor floor lamp  
Lampadaire extérieure  
Outdoor Stehlampe  
Lampara de pie de exterior

Accessori inclusi / Accessories included / Accessoires fournis / Accesorios incluidos / Mitgeliefertes Zubehör:

Cavo di alimentazione 150 cm / Power supply cable 150 cm

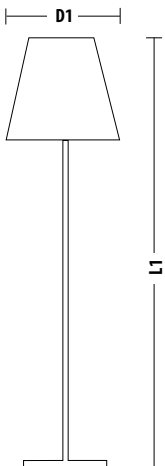

Codice Prodotto Item code Code Codigo Code	Diametro D1 Diameter Diamètre Diámetro Breite	Altezza L1 Height Hauteur Altura Höhe	Imballo Packing Emballage Embalaje Verpackung	Inner Pces	Master Pces
TL3430	340 mm	1500 mm	Colour box	-	1

TL3430



## SOLARE & AUTONOMO

Solar lighting / Eclairage solaire / Iluminacion con carga solar / Solarbeleuchtung

### SPK02 - BLOSSOM

Lampada solare LED da giardino  
Solar garden LED light  
Borne solaire LED  
Lampara LED con recarga solar para el jardin  
Solar LED-Gartenlampe



Solar  
Charging

SPK02



COD.								Packing	Inner Pcs	Master Pcs
<b>SPK02</b>	1 Standard LED	2 Lm	8 hrs	Diffuse Light	ø 56 x 260 mm	Ni-Mh AAA 1,2V 100mAh (included)	ABS	Display 20 pcs	20	40

### SPK03 - BLOSSOM

Lampada solare LED da giardino  
Solar garden LED light  
Borne solaire LED  
Lampara LED con recarga solar para el jardin  
Solar LED-Gartenlampe



Solar  
Charging

SPK03



COD.								Packing	Inner Pcs	Master Pcs
<b>SPK03</b>	1 Standard LED	2 Lm	8 hrs	Diffuse Light	ø 56 x 260 mm	Ni-Mh AAA 1,2V 100mAh (included)	ABS	Display 20 pcs	20	40

### SPK05 - POLE

Lampada solare LED da giardino  
Solar garden LED light  
Borne solaire LED  
Lampara LED con recarga solar para el jardin  
Solar LED-Gartenlampe



Solar  
Charging

SPK05



COD.								Packing	Inner Pcs	Master Pcs
<b>SPK05</b>	1 Standard LED	2 Lm	6 hrs	Diffuse Light	47 x 47 x 330 mm	1 x 1,2V 200mAh Ni-Mh (included)	ABS	Display 24 pcs	24	48



### SPK10 - GLOBE

Lampada solare LED da giardino  
 Solar garden LED light  
 Borne solaire LED  
 Lampara LED con recarga solar para el jardin  
 Solar LED-Gartenlampe



Solar Charging



SPK10



COD.								Packing	Inner Pces	Master Pces
SPK10	1 Standard LED	2 Lm	8 hrs	Diffuse Light	100 x 100 x 340 mm	1 x AAA 1,2V 100mAh Ni-Mh (included)	ABS	Display 20 pces	20	40

### SPK08 - BULB LIGHT

Lampada solare LED da giardino  
 Solar garden LED light  
 Borne solaire LED  
 Lampara LED con recarga solar para el jardin  
 Solar LED-Gartenlampe



Solar Charging



SPK08



COD.								Packing	Inner Pces	Master Pces
SPK08	4 micro LED	2 Lm	4 hrs	Diffuse Light	76 x 76 x 185 mm	1,2V 40 mAh Ni-Mh (included)	ABS	Display 12 pces	-	12



# SOLARE & AUTONOMO

Solar lighting / Eclairage solaire / Illuminacion con carga solar / Solarbeleuchtung



## SPK12 - OLYMPIA

Lampada solare LED da giardino  
Solar garden LED light  
Borne solaire LED  
Lampara LED con recarga solar para el jardin  
Solar LED-Gartenlampe



COD.									Packing	Inner Pces	Master Pces
SPK12	36 SMD LED	N/S	5 hrs	Diffuse Light	51 x 7,5 mm	1,2V 200mAh Ni-Mh	Amorphous solar panel	ABS	Display 12 pces	-	12

## SPK59 - OLYMPIA XL



COD.									Packing	Inner Pces	Master Pces
SPK59	36 SMD LED	N/S	5 hrs	Diffuse Light	ø95 x 590 mm	1,2V 200mAh Ni-Mh	Amorfoous solar panel	ABS	Colour box 2 pces	6	12



### SPK14 - DISCO

Segnapassi solare LED da muro  
LED solar wall lamp  
Applique solaire à LED  
Lámpara de pared solar LED  
Solar-LED-Wandsockel



**NEW**



Solar Charging

SPK14



COD.									Packing	Inner Pces	Master Pces
<b>SPK14</b>	1 SMD LED	2 Lm	6 hrs	Focus light	ø 75 mm	AAA 1.2V 100mAh Ni-Mh	Amorphous solar panel	ABS	Display 20 pces	20	40

### SPK16 - ENTERPRISE

Set di 2 Lampade solari LED da giardino  
Set of 2 LED solar garden lamps  
Set de 2 lampes de jardin solaires LED  
Juego de 2 luces LED solares para jardín  
Set mit 2 LED-Solar-Gartenleuchten



**NEW**



Solar Charging

SPK16



COD.									Packing	Inner Pces	Master Pces
<b>SPK16</b>	SMD LED	5 Lm	5 hrs	Diffuse Light	ø 112 x 21 mm	1,2V 500mAh Ni-Mh	Polycrystal silicon solar panel	ABS + PC	Colour box 2 pces	6	24

# Indoor lighting



# VELAMP® Una ricca gamma di lampadine LED

A grande richiesta, Velamp ti propone una ricca gamma di lampadine LED per soddisfare le richieste di:

- **Prezzo:** con la gamma SMD in termoplastica
- **Effetto luminoso:** con l'importanza data alle gamme filament e filament "opal" che danno un effetto visivo molto vicino alle lampadine ad incandescenza
- **Qualità:** gamma interamente certificata TÜV
- **Rotazioni:** Velamp ha particolarmente lavorato i suoi packaging per rendere l'esposizione più chiara e a maggior vendibilità

By popular demand, Velamp offers you a wide range of LED bulbs to meet the demands of:

- **Price:** with the thermoplastic SMD range
- **Luminous effect:** with the importance given to the "opal" filament and filament ranges which give a visual effect very close to incandescent bulbs
- **Quality:** fully TÜV certified range
- **Rotations:** Velamp has particularly worked on its packaging to make the display clearer and more salable

## Offriamo 5 gamme di prodotti:

## We offer 5 product ranges:



SMD

SFERA  
P45

GOCCIA  
A60

GOCCIA  
A65

OLIVA  
C37

SFERA  
P45

### Lampadine LED SMD

Diffusore opalizzato che rende la luce omogenea, non abbagliante, e ben diffusa (angolo 220°).

### SMD LED bulbs

Opalized diffuser that makes the light homogeneous, not glaring, and well diffused (angle 220°).

### 3 colori di luce:

**3 colors of light:**  
3000K / 4000K / 6500K

Fino a 20W  
Up to 20W



SMD SPOT

FLOOD  
PAR16



SPOT  
PAR16



### Lampadine LED SMD GU10

Disponibile nelle due varianti: lente direzionale (angolo 38°) per un angolo di luce focalizzato e diffusore opalizzato (angolo 120°) che rende la luce omogenea, non abbagliante, e ben diffusa.

### GU10 SMD LED Bulbs

Available in two variants: directional lens (38° angle) for a focused light angle and opalized diffuser (120° angle) which makes the light homogeneous, not glaring, and well diffused.

### 2 colori di luce:

**2 colors of light:**  
3000K / 4000K

Fino a 8W  
Up to 8W



Speciali

OVEN  
ST26

FRIDGE  
ST26

CAPSULA  
G9

CAPSULA  
G9

### Lampadine speciali:

Per tutte le applicazioni quotidiane di casa: lampadari, frigoriferi, forno...

### Special bulbs:

For all daily home applications: chandeliers, refrigerators, ovens...



## Crystal Filament



SFERA  
P45

GOCCIA  
A60

OLIVA  
C35

SFERA  
P45



### Lampadine LED a filamento

Diffusore trasparente che rende la luce molto somigliante alle vecchie lampadine ad incandescenza. La tecnologia "LED filament" dà un fascio iper diffuso a 330°.

### LED filament bulbs

Transparent diffuser that makes the light very similar to old incandescent bulbs. The "LED filament" technology gives a hyper diffused 330° beam.

2 colori di luce:  
2 colors of light:  
2700K / 4000K

Fino a 12W  
Up to 12W



## Opal Filament



SFERA  
P45

GOCCIA  
A60

Globo  
G125

OLIVA  
C35

SFERA  
P45



### Lampadine LED a filamento con diffusore "Opal"

Diffusore opalizzato che rende la luce molto omogenea e non abbagliante. L'effetto è molto somigliante alle vecchie lampadine ad incandescenza. La tecnologia "LED filament" dà un fascio iper diffuso a 330°.

### LED filament bulbs with "Opal" diffuser

Opalized diffuser that makes the light very homogeneous and not dazzling. The effect is very similar to old incandescent light bulbs. The "LED filament" technology gives a hyper diffused 330° beam.

3 colori di luce:  
3 colors of light:  
3000K / 4000K / 6500K

Fino a 18W  
Up to 18W



# SORGENTI LED CLASSICHE

Classic LED bulbs

SMD



## Descrizione / Description

Lampadina LED SMD. Con una vita utile di 20.000 ore, la lampadina può durare oltre 15 anni (con un uso giornaliero di 3 ore). Diffusore opalizzato che rende la luce omogenea, non abbagliante, e ben diffusa (angolo 180°, 200° o 220°). Perfetta per tutte le stanze di casa come cameretta, soggiorno, bagno... e per l'ufficio.

SMD LED Bulb. With a useful life of 20,000 hours, the bulb can last over 15 years (with a daily use of 3 hours). Opalized diffuser that makes the light homogeneous, not glaring, and well diffused (angle 180°, 200° or 220°). Perfect for all rooms in the house such as a bedroom, living room, bathroom ... and for the office.

## Caratteristiche / Features



Codice prodotto Item code Code article Código de producto Produktcode	Codice Ean Ean Code Code Ean Codigo Ean Eancode	Attacco Lamp holder Culot Watt Ataco Watt Halterung	Watt Watt Watt Watt	Equivalenza W Equivalence W Equivalencia W Äquivalenz W	Lumen Lumen Lumen Lumen	°K °K °K °K	Angolo (°) Degree Angle Ángulo Winkel	Absorbimento (A) Absorption Absorption Absorción Absorption	Classe energetica Energy class Classe énergétique Calificación energética Energieeffizienzklasse	Inner Qty	Master Qty	Forma della lampadina Bulb shape Forme de l'ampoule Forma de bulbo Zwiebelform
LB40675-30K	8003910108851	E27	6	42	490	3000K	200°	0,052	G	10	100	Sfera P45  45ø x 80
LB40675-40K	8003910108868	E27	6	42	490	4000K	200°	0,052	G	10	100	
LB40675-65K	8003910108875	E27	6	42	490	6500K	200°	0,052	G	10	100	
LB2095-30K	8003910108615	E27	9	60	820	3000K	200°	0,078	F	10	100	60ø x 108 
LB2095-40K	8003910108622	E27	9	60	820	4000K	200°	0,078	F	10	100	
LB2095-65K	8003910108639	E27	9	60	820	6500K	200°	0,078	F	10	100	
LB2125-30K	8003910108646	E27	11	75	1055	3000K	200°	0,104	F	10	100	Goccia A60  60ø x 110
LB2125-40K	8003910108653	E27	11	75	1055	4000K	200°	0,104	F	10	100	
LB2125-65K	8003910108660	E27	11	75	1055	6500K	200°	0,104	F	10	100	
LB2155-30K	8003910108677	E27	15	100	1521	3000K	200°	0,130	F	10	100	60ø x 123 
LB2155-40K	8003910108684	E27	15	100	1521	4000K	200°	0,130	F	10	100	
LB2155-65K	8003910108691	E27	15	100	1521	6500K	200°	0,130	F	10	100	
LB2205-30K	8003910108707	E27	20	142	2300	3000K	200°	0,173	E	10	100	Goccia A65  65ø x 133
LB2205-40K	8003910108714	E27	20	142	2300	4000K	200°	0,173	E	10	100	
LB2205-65K	8003910108721	E27	20	142	2300	6500K	200°	0,173	E	10	100	

# SORGENTI LED CLASSICHE

Classic LED bulbs



SMD







## Descrizione / Description

Lampadina LED SMD. Con una vita utile di 20.000 ore, la lampadina può durare oltre 15 anni (con un uso giornaliero di 3 ore). Diffusore opalizzato che rende la luce omogenea, non abbagliante, e ben diffusa (angolo 20°). Perfetta per tutte le stanze di casa come cameretta, soggiorno, bagno...e per l'ufficio.

Ampoules LED SMD. Avec une durée de vie utile de 20 000 heures, les ampoules peuvent durer plus de 15 ans (avec une utilisation quotidienne de 3 heures). Diffuseur opalisé qui rend la lumière homogène, non éblouissante et bien diffusée (angle 20°). Parfaites pour toutes les pièces de la maison: chambre, salon, salle de bain... et le bureau

## Caratteristiche / Features



Codice prodotto Item code Code article Código de producto Produktcode	Codice Ean Ean Code Code Ean Codigo Ean Eancode	Attacco Lamp holder Culot Ataco Halterung	Watt Watt Watt Watt Watt	Equivalenza W Equivalence W Equivalencia W Äquivalenz W	Lumen Lumen Lumen Lumen	*K °K °K °K °K	Angolo (°) Degree Angle Ángulo Winkel	Assorbimento (A) Absorption Absorption Absorption	Classe energetica Energy class Classe énergétique Calificación energética Energieeffizienzklasse	Inner Qty	Master Qty	Forma della lampadina Bulb shape Forme de l'ampoule Forma de bulbo Zwiebelform
LB4065F-30K	8003910108882	B22	6	42	490	3000K	200°	0,052	G	10	100	Sfera P45 
LB4065F-40K	8003910108899	B22	6	42	490	4000K	200°	0,052	G	10	100	
LB2095F-30K	8003910108738	B22	9	60	820	3000K	200°	0,078	F	10	100	60ø x 108 
LB2095F-40K	8003910108745	B22	9	60	820	4000K	200°	0,078	F	10	100	
LB2125F-30K	8003910108752	B22	11	75	1055	3000K	200°	0,104	F	10	100	Goccia A60 
LB2125F-40K	8003910108769	B22	11	75	1055	4000K	200°	0,104	F	10	100	
LB2155F-30K	8003910108776	B22	15	100	1521	3000K	200°	0,130	F	10	100	
LB2155F-40K	8003910108783	B22	15	100	1521	4000K	200°	0,130	F	10	100	60ø x 123 

# SORGENTI LED CLASSICHE

Classic LED bulbs



## SMD



E14



OLIVA  
C37



SFERA  
P45



### Descrizione / Description

Lampadina LED SMD. Con una vita utile di 20.000 ore, la lampadina può durare oltre 15 anni (con un uso giornaliero di 3 ore). Diffusore opalizzato che rende la luce omogenea, non abbagliante, e ben diffusa (angolo 220°). Perfetta per tutte le stanze di casa come camera, soggiorno, bagno...e per l'ufficio.

SMD LED Bulb. With a useful life of 20,000 hours, the bulb can last over 15 years (with a daily use of 3 hours). Opalized diffuser that makes the light homogeneous, not glaring, and well diffused (angle 220°). Perfect for all rooms in the house such as a bedroom, living room, bathroom ... and for the office.

### Caratteristiche / Features



Codice prodotto Item code Code article Código de producto Produktcode	Codice Ean Ean Code Code Ean Código Ean Eancode	Attacco Lamp holder Culot Ataco Halterung	Watt Watt Watt Watt	Equivalenza W Equivalence W Ecuivalencia W Äquivalenz W.	Lumen Lumen Lumen Lumen	°K °K °K °K	Angolo (°) Degree Angle Ángulo Winkel	Absorbimento (A) Absorption Absorption Absorción Absorption	Classe energetica Energy class Classe énergétique Calificación energética Energieeffizienzklasse	Inner Qty	Master Qty	Forma della lampadina Bulb shape Forme de l'ampoule Forma de bulbo Zwiebelform
LB3065-30K	8003910108790	E14	6	42	490	3000K	200°	0,052	G	10	100	Oliva C37 
LB3065-40K	8003910108806	E14	6	42	490	4000K	200°	0,052	G	10	100	
LB3065-65K	8003910108813	E14	6	42	490	6500K	200°	0,052	G	10	100	
LB4065-30K	8003910108820	E14	6	42	490	3000K	200°	0,052	G	10	100	Sfera P45 
LB4065-40K	8003910108837	E14	6	42	490	4000K	200°	0,052	G	10	100	
LB4065-65K	8003910108844	E14	6	42	490	6500K	200°	0,052	G	10	100	



# SORGENTI LED CLASSICHE

## Classic LED bulbs



# SMD



### Descrizione / Description

Lampadina LED SMD GU10. Con una vita utile di 20.000 ore, la lampadina può durare oltre 15 anni (con un uso giornaliero di 3 ore). Disponibile nelle due varianti: lente direzionale (angolo 38°) per un angolo di luce focalizzato e diffusore opalizzato (angolo 120°) che rende la luce omogenea, non abbagliante, e ben diffusa. Perfetta per tutte le stanze di casa come cameretta, soggiorno, bagno... e per l'ufficio.

SMD LED Bulb GU10. With a useful life of 20,000 hours, the bulb can last over 15 years (with a daily use of 3 hours). Available in two versions: directional lens (angle 38 °) for an angle of focused light and opalized diffuser (angle 120 °) which makes the light homogeneous, not glaring, and well diffused. Perfect for all rooms in the house such as a bedroom, living room, bathroom ... and for the office.

### Caratteristiche / Features



Codice prodotto Item code Code article Código de producto Produktcode	Codice Ean Ean Code Code Ean Código Ean Eancode	Attacco Lamp holder Culot Ataco Watt Halterung	Watt Watt Watt Watt	Equivalenza W Equivalence W Equivalencia W Äquivalenz W.	Lumen Lumen Lumen	°K °K °K °K	Angolo (°) Degree Angle Angulo Winkel	Assorbimento (A) Absorption Absorption Absorción Absorption	Classe energetica Energy class Classe énergétique Calificación energética Energieeffizienzklasse	Inner Qty	Master Qty	Forma della lampadina Bulb shape Forme de l'ampoule Forma de bulbo Zwiebelform
<b>LB106-30K</b>	8003910108905	GU10	6	42	<b>490</b>	<b>3000K</b>	110°	0,052	G	10	200	
<b>LB106-40K</b>	8003910108912	GU10	6	42	<b>490</b>	4000K	110°	0,052	G	10	200	
<b>LB106-65K</b>	8003910110069	GU10	6	40	<b>490</b>	<b>6500K</b>	110°	0,052	G	10	200	
<b>LB108-30K</b>	8003910108929	GU10	8.5	60	<b>806</b>	<b>3000K</b>	110°	0,069	F	10	200	
<b>LB108-40K</b>	8003910108936	GU10	8.5	60	<b>806</b>	4000K	110°	0,069	F	10	200	
<b>LB108-65K</b>	8003910110076	GU10	8.5	60	<b>806</b>	<b>6500K</b>	110°	0,069	F	10	200	
<b>LB156-30K</b>	8003910108943	GU10	6	40	<b>450</b>	<b>3000K</b>	38°	0,052	F	10	200	Spot PAR16  50ø x 58
<b>LB156-40K</b>	8003910108950	GU10	6	40	<b>450</b>	4000K	38°	0,052	F	10	200	
<b>LB158-30K</b>	8003910108967	GU10	8	55	<b>650</b>	<b>3000K</b>	38°	0,069	F	10	200	
<b>LB158-40K</b>	8003910108974	GU10	8	55	<b>650</b>	4000K	38°	0,069	F	10	200	

# SORGENTI LED FILAMENTO

## Filament LED bulbs

### Crystal Filament



#### Descrizione / Description

Lampadina LED a filamento. Con una vita utile di 20.000 ore, la lampadina può durare oltre 15 anni (con un uso giornaliero di 3 ore). Diffusore trasparente che rende la luce molto somigliante alle vecchie lampadine ad incandescenza. La tecnologia "LED filament" dà un fascio iper diffuso a 330°. Perfetta per tutte le stanze di casa come cameretta, soggiorno, bagno...e per l'ufficio.

LED filament bulb. With a useful life of 20,000 hours, the bulb can last over 15 years (with a daily use of 3 hours). Transparent diffuser that makes the light very similar to old incandescent bulbs. The "LED filament" technology gives a hyper diffused beam at 330°. Perfect for all rooms of the house such as a bedroom, living room, bathroom ... and for the office.

#### Caratteristiche / Features



Codice prodotto Item code Code article Código de producto Produktcode	Codice Ean Ean Code Code Ean Codigo Ean Eancode	Attacco Lamp holder Culot Ataco Halterung	Watt Watt Watt Watt Watt	Equivalenza W Equivalence W Equivalencia W Äquivalenz W.	Lumen Lumen Lumen Lumen Lumen	°K °K °K °K °K	Angolo (°) Degree Angle Angulo Winkel	Assorbimento (A) Absorption Absorption Absorción Absorption	Classe energetica Energy class Classe énergétique Calificación energética Energieeffizienzklasse	Inner Qty	Master Qty	Forma della lampadina Bulb shape Forme de l'ampoule Forma de bulbo Zwiebelform
LB4047C-27K	8003910109254	E27	4	40	470	2700K	330°	0,043	E	10	100	Sfera P45  45ø x 80
LB4047C-40K	8003910109261	E27	4	40	470	4000K	330°	0,043	E	10	100	
LB4067C-27K	8003910109292	E27	6	60	806	2700K	330°	0,052	E	10	100	
LB4067C-40K	8003910109308	E27	6	60	806	4000K	330°	0,052	E	10	100	
LB207C-27K	8003910108981	E27	7	60	806	2700K	330°	0,060	E	10	100	Goccia A60  60ø x 108
LB207C-40K	8003910108998	E27	7	60	806	4000K	330°	0,060	E	10	100	
LB208C-27K	8003910109032	E27	8	75	1055	2700K	330°	0,069	E	10	100	
LB208C-40K	8003910109049	E27	8	75	1055	4000K	330°	0,069	E	10	100	
LB212C-27K	8003910109087	E27	12	100	1521	2700K	330°	0,104	E	10	100	
LB212C-40K	8003910109094	E27	12	100	1521	4000K	330°	0,104	E	10	100	

# SORGENTI LED FILAMENTO

Filament LED bulbs

## Crystal Filament



E14

OLIVA  
C35

SFERA  
P45



### Descrizione / Description

Lampadina LED a filamento. Con una vita utile di 20.000 ore, la lampadina può durare oltre 15 anni (con un uso giornaliero di 3 ore). Diffusore trasparente che rende la luce molto somigliante alle vecchie lampadine ad incandescenza. La tecnologia "LED filament" dà un fascio iper diffuso a 330°. Perfetta per tutte le stanze di casa come cameretta, soggiorno, bagno...e per l'ufficio.

LED filament bulb. With a useful life of 20,000 hours, the bulb can last over 15 years (with a daily use of 3 hours). Transparent diffuser that makes the light very similar to old incandescent bulbs. The "LED filament" technology gives a hyper diffused beam at 330°. Perfect for all rooms of the house such as a bedroom, living room, bathroom ... and for the office.

### Caratteristiche / Features



Codice prodotto Item code Code article Código de producto Produktcode	Codice Ean Ean Code Code Ean Codigo Ean Eancode	Attacco Lamp holder Culot Ataco Halterung	Watt Watt Watt Watt	Equivalenza W Equivalence W Equivalencia W Äquivalenz W	Lumen Lumen Lumen Lumen	°K °K °K °K	Angolo (°) Degree Angle Angulo Winkel	Assorbimento (A) Absorption Absorption Absorción Absorption	Classe energetica Energy class Classe énergétique Calificación energética Energieeffizienzklasse	Inner Qty	Master Qty	Forma della lampadina Bulb shape Forme de l'ampoule Forma de bulbo Zwiebelform
LB304C-27K	8003910109131	E14	4	40	470	2700K	330°	0,043	E	10	100	Oliva C35  35ø x 98
LB304C-40K	8003910109148	E14	4	40	470	4000K	330°	0,043	E	10	100	
LB306C-27K	8003910109155	E14	6	60	806	2700K	330°	0,052	E	10	100	
LB306C-40K	8003910109162	E14	6	60	806	4000K	330°	0,052	E	10	100	
LB404C-27K	8003910109230	E14	4	40	470	2700K	330°	0,043	E	10	100	Sfera P45  45ø x 80
LB404C-40K	8003910109247	E14	4	40	470	4000K	330°	0,043	E	10	100	
LB406C-27K	8003910109278	E14	6	60	806	2700K	330°	0,052	E	10	100	
LB406C-40K	8003910109285	E14	6	60	806	4000K	330°	0,052	E	10	100	

# SORGENTI LED FILAMENTO

Filament LED bulbs

## Opal Filament



SFERA  
P45

GOCCIA  
A60

Globo  
G125



### Descrizione / Description

Lampadina LED a filamento con diffusore "Opal". Con una vita utile di 20.000 ore, la lampadina può durare oltre 15 anni (con un uso giornaliero di 3 ore). Diffusore opalizzato che rende la luce molto omogenea e non abbagliante. L'effetto è molto somigliante alle vecchie lampadine ad incandescenza. La tecnologia "LED filament" dà un fascio iper diffuso a 330°. Perfetta per tutte le stanze di casa come camera, soggiorno, bagno...e per l'ufficio.

LED filament bulb with "Opal" diffuser. With a useful life of 20,000 hours, the bulb can last over 15 years (with daily use of 3 hours). Opalized diffuser that makes the light very homogeneous and not dazzling. The effect is very similar to old incandescent light bulbs. The "LED filament" technology gives a hyper diffused 330° beam. Perfect for all rooms in the house such as a bedroom, living room, bathroom ... and for the office.

### Caratteristiche / Features



Codice prodotto Item code Code article Código de producto Produktcode	Codice Ean Ean Code Code Ean Codigo Ean Eancode	Attacco Lamp holder Culot Ataco Watt Halterung	Watt Watt Watt Watt	Equivalenza W Equivalence W Equivalence W Äquivalenz W	Lumen Lumen Lumen Lumen	°K °K °K °K	Angolo (°) Degree Angle Ángulo Winkel	Assorbimento (A) Absorption Absorption Absorption Absorption	Classe energetica Energy class Classe énergétique Calificación energética Energieeffizienzklasse	Inner Qty	Master Qty	Forma della lampadina Bulb shape Forme de l'ampoule Forma de bulbo Zwiebelform
LB4047M-30K	8003910109346	E27	4	40	470	3000K	330°	0,043	E	10	100	Sfera P45  45ø x 80
LB4047M-40K	8003910109353	E27	4	40	470	4000K	330°	0,043	E	10	100	
LB4047M-65K	8003910109360	E27	4	40	470	6500K	330°	0,043	E	10	100	
LB4067M-30K	8003910109407	E27	6	60	806	3000K	330°	0,052	E	10	100	
LB4067M-40K	8003910109414	E27	6	60	806	4000K	330°	0,052	E	10	100	
LB4067M-65K	8003910109421	E27	6	60	806	6500K	330°	0,052	E	10	100	
LB207M-30K	8003910109001	E27	7	60	806	3000K	330°	0,060	E	10	100	Goccia A60  60ø x 108
LB207M-40K	8003910109018	E27	7	60	806	4000K	330°	0,060	E	10	100	
LB207M-65K	8003910109025	E27	7	60	806	6500K	330°	0,060	E	10	100	
LB208M-30K	8003910109056	E27	8	75	1055	3000K	330°	0,069	E	10	100	
LB208M-40K	8003910109063	E27	8	75	1055	4000K	330°	0,069	E	10	100	
LB208M-65K	8003910109070	E27	8	75	1055	6500K	330°	0,069	E	10	100	
LB212M-30K	8003910109100	E27	12	100	1520	3000K	330°	0,104	E	10	100	Globo 125  125ø x 175
LB212M-40K	8003910109117	E27	12	100	1520	4000K	330°	0,104	E	10	100	
LB212M-65K	8003910109124	E27	12	100	1520	6500K	330°	0,104	E	10	100	
LB512M-30K	8003910109438	E27	12	100	1520	3000K	330°	0,104	E	10	40	
LB512M-40K	8003910109445	E27	12	100	1520	4000K	330°	0,104	E	10	40	
LB512M-65K	8003910109452	E27	12	100	1520	6500K	330°	0,104	E	10	40	
LB518M-30K	8003910109469	E27	18	150	2500	3000K	330°	0,156	D	10	40	
LB518M-40K	8003910109476	E27	18	150	2500	4000K	330°	0,156	D	10	40	
LB518M-65K	8003910109483	E27	18	150	2500	6500K	330°	0,156	D	10	40	

# SORGENTI LED FILAMENTO

## Filament LED bulbs

### Opal Filament





#### Descrizione / Description

Lampadina LED a filamento con diffusore "Opal". Con una vita utile di 20.000 ore, la lampadina può durare oltre 15 anni (con un uso giornaliero di 3 ore). Diffusore opalizzato che rende la luce molto omogenea e non abbagliante. L'effetto è molto somigliante alle vecchie lampadine ad incandescenza. La tecnologia "LED filament" dà un fascio iper diffuso a 330°. Perfetta per tutte le stanze di casa come camera, soggiorno, bagno...e per l'ufficio.

LED filament bulb with "Opal" diffuser. With a useful life of 20,000 hours, the bulb can last over 15 years (with daily use of 3 hours). Opalized diffuser that makes the light very homogeneous and not dazzling. The effect is very similar to old incandescent light bulbs. The "LED filament" technology gives a hyper diffused 330° beam. Perfect for all rooms in the house such as a bedroom, living room, bathroom ... and for the office.

#### Caratteristiche / Features



Codice prodotto Item code Code article Código de producto Produktcode	Codice Ean Ean Code Code Ean Codigo Ean Eancode	Attacco Lamp holder Culot Ataco Watt Halterung	Watt Watt Watt Watt	Equivalenza W Equivalence W Equivalence W Equivalencia W Äquivalenz W.	Lumen Lumen Lumen Lumen	°K °K °K °K	Angolo (°) Degree Angle Ángulo Winkel	Assorbimento (A) Absorption Absorption Absorción Absorption	Classe energetica Energy class Classe énergétique Calificación energética Energieeffizienzklasse	Inner Qty	Master Qty	Forma della lampadina Bulb shape Forme de l'ampoule Forma de bulbo Zwiebelform
LB304M-30K	8003910109179	E14	4	40	470	3000K	330°	0,043	E	10	100	Oliva C35 
LB304M-40K	8003910109186	E14	4	40	470	4000K	330°	0,043	E	10	100	
LB304M-65K	8003910109193	E14	4	40	470	6500K	330°	0,043	E	10	100	
LB306M-30K	8003910109209	E14	6	60	806	3000K	330°	0,052	E	10	100	
LB306M-40K	8003910109216	E14	6	60	806	4000K	330°	0,052	E	10	100	
LB306M-65K	8003910109223	E14	6	60	806	3000K	330°	0,052	E	10	100	
LB404M-30K	8003910109315	E14	4	40	470	3000K	330°	0,043	E	10	100	Sfera P45 
LB404M-40K	8003910109322	E14	4	40	470	4000K	330°	0,043	E	10	100	
LB404M-65K	8003910109339	E14	4	40	470	6500K	330°	0,043	E	10	100	
LB406M-30K	8003910109377	E14	6	60	806	3000K	330°	0,052	E	10	100	
LB406M-40K	8003910109384	E14	6	60	806	4000K	330°	0,052	E	10	100	
LB406M-65K	8003910109391	E14	6	60	806	6500K	330°	0,052	E	10	100	

## SORGENTI SPECIALI

Special bulbs



## Oven



Codice prodotto	Codice Ean	Attacco	Watt	Equivalenza W	Lumen	°K	Angolo (°)	Assorbimento	Classe energetica	Inner Qty	Master Qty	Forma della lampadina
Item code	Ean Code	Lamp holder	Watt	Equivalence W	Lumen	°K	Degree	(A) Absorption	Energy class			Bulb shape
Code article	Code Ean	Culot	Watt	Equivalence W	Lumen	°K	Angle	Absorption	Classe énergétique			Forme de l'ampoule
Código de producto	Código Ean	Ataco	Watt	Equivalencia W	Lumen	°K	Ángulo	Absorción	Calificación energética			Forma de bulbo
Produktcode	Eancode	Halterung	Watt	Äquivalenz W.	Lumen	°K	Winkel	Absorption	Energieeffizienzklasse			Zwiebelform

LB9030-27K 8003910109742 E14 15 15 100 2700K 300° - E 10 80 Oven ST26



## Fridge



### Descrizione / Description

Consente un risparmio energetico dell'88%, riducendo i costi operativi nel pieno rispetto dell'ambiente senza rinunciare alla praticità di utilizzo. Idonea per abat-jour, frigorifero e applicazioni domestiche

*It allows you to save an energy saving up to 88%, reduce operating costs while respecting the environment without sacrificing practicality of use. Suitable for lampshades, refrigerators and domestic applications*

Codice prodotto	Codice Ean	Attacco	Watt	Equivalenza W	Lumen	°K	Angolo (°)	Assorbimento	Classe energetica	Inner Qty	Master Qty	Forma della lampadina
Item code	Ean Code	Lamp holder	Watt	Equivalence W	Lumen	°K	Degree	(A) Absorption	Energy class			Bulb shape
Code article	Code Ean	Culot	Watt	Equivalence W	Lumen	°K	Angle	Absorption	Classe énergétique			Forme de l'ampoule
Código de producto	Código Ean	Ataco	Watt	Equivalencia W	Lumen	°K	Ángulo	Absorción	Calificación energética			Forma de bulbo
Produktcode	Eancode	Halterung	Watt	Äquivalenz W.	Lumen	°K	Winkel	Absorption	Energieeffizienzklasse			Zwiebelform

LB901F-30K 8003910109759 E14 3 20 200 3000K 300° - A+ 10 80 Fridge ST26



# SORGENTI LED SPECIALI

Special LED bulbs



SMD





## Descrizione / Description

Queste lampadine garantiscono un grande risparmio energetico rispetto alle G9 alogene (90%) e una illuminazione brillante grazie all'elegante design trasparente. Effetto naturale garantito per tutte le applicazioni decorative, illuminazione d'accento che crea atmosfera in tutta la casa, sale d'attesa, uffici negozi e ristoranti.

*These bulbs guarantee great energy savings compared to halogen G9s (up to 90%) and bright lighting thanks to the elegant transparent design. Natural effect guaranteed for all decorative applications, accent lighting that creates atmosphere throughout the house, waiting rooms, offices, shops and restaurants.*

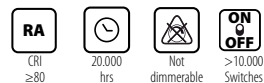
## Caratteristiche / Features



Codice prodotto Item code Code article Código de producto Produktcode	Codice Ean Ean Code Code Ean Código Ean Eancode	Attacco Lamp holder Culot Ataco Haltering	Watt Watt Watt Watt	Equivalenza W Equivalence W Equivalencia W Äquivalenz W	Lumen Lumen Lumen Lumen	°K °K °K °K	Angolo (°) Degree Angle Ángulo Winkel	Assorbimento (A) Absorption Absorption Absorción Absorption	Classe energetica Energy class Classe énergétique Calificación energética Energieeffizienzklasse	Inner Qty	Master Qty	Forma della lampadina Bulb shape Forme de l'ampoule Forma de bulbo Zwiebelform
LB993-30K	8003910109612	G9	3,5	30	300	3000K	300°	0,040	A+	10	100	Capsula G9  17ø x 50
LB993-40K	8003910109629	G9	3,5	30	300	4000K	300°	0,040	A+	10	100	
LB994-30K	8003910109636	G9	4,5	35	400	3000K	300°	0,048	A+	10	100	Capsula G9  16,2ø x 60
LB994-40K	8003910109643	G9	4,5	35	400	4000K	300°	0,048	A+	10	100	

# SCATOLE PARLANTI

Scatole chiare ed illustrative per aiutarti nella scelta del prodotto giusto!

Qualsiasi sia il negozio, bisogna scegliere il prodotto giusto in poco tempo. Velamp ha creato una scatola che permette, a te e al tuo cliente, di scegliere il prodotto giusto velocemente ed in autonomia.

La scatola è stata concepita e strutturata su 4 livelli di lettura:

- Colore principale della scatola per identificare subito il tipo di luce
- Forma della lampadina identificabile grazie all'apertura che consente di vedere il prodotto senza dover aprire la scatola
- Informazioni chiare su lumen e potenza equivalente
- Foto dell'attacco + scatola aperta sulla base per una conferma immediata

Wherever you are, you have to choose the right product in a short time. Velamp has designed a box that allows you and your customer to choose the right product quickly and independently.

The box is set on 4 reading levels:

- Main color of the box to immediately identify the temperature of light
- Bulb shape identifiable thanks to the opening that allows to see the product without having to open the box
- Clear information on lumens and equivalent power
- Photo of the socket + open box on the base for immediate confirmation of the socket



Appendibile / Hangable



Visione della base  
Vision of base

Etichetta energetica conforme alla normativa UE 2019/2015  
Energy label compliant with EU regulation 2019/2015



QR code per accesso alla scheda prodotto  
QR code for access to the data sheet

Identificativo del colore della luce con scala colori + colore packaging  
Light color identifier with color scale + packaging color

Tabella dati completi  
Complete data table



Codice a barre  
Ean code

Codice prodotto  
Item code



Forma della lampadina  
Bulb shape

Pittogrammi di sicurezza  
Safety pictograms



Classe energetica  
Energy class

Identificativo del colore della luce con scala colori + colore packaging  
Light color identifier with color scale + packaging color

Angolo / Degree

Tipo attacco  
Lamp holder type

Lumen / Watt

Equivalenza con incandescenza  
Equivalence with incandescent lamp



N° cicli accensione  
Number of cycles

Non dimmerabile  
Not dimmerable

Dimensioni della lampada  
Lamp dimensions



# IMPIANTI & LAY-OUTS



La chiarezza dell'impianto è un fattore chiave per la rotazione del banco lampadine. Velamp, forte della sua cultura espositiva, propone lay-out "chiavi in mano" che guidano il cliente nella ricerca del prodotto giusto. Questo per garantirvi rotazioni altissime e bassi resi.

*A clear and organized lay-out is a key factor for the rotation of the lamp shelf. Velamp, thanks to its lay out culture, offers to its customers ready to sell layouts that guide the customer in finding the right product. This is a guarantee of high rotations and low returns.*



# DURANDAL

Indoor lighting



CRI >80



30.000 hrs



Switch



Not Dimmable



Protection class



Insulation class



Energy class



RS SERIES

Codice Prodotto Item code Code Codigo Code	Alimentazione Power source Alimentation Alimentación Stromversorgung	Tecnologia della Luce Light technology Technologie de la lumière Tecnología de iluminación Beleuchtungstechnologie	Potenza (W) Watt power Puissance Potencia Leistung	Comparazione Cfl CFL equivalent Equivalence CFL Ecuivalencia CFL CFL Äquivalent	Lumen Lumen Lumen Lumen Lumen	Tipo di luce Kelvin degrees Kelvin Temperatura de luz °K	Materiale Material Materiu Material Material	Apertura Fascio Kind of beam Type de faisceau Tipo de haz Ausstrahlungswinkel	Collegamenti Connections Connexions Conexiones Anschlüsse
<b>RS4-4W</b>	220V-240V ~ 50/60 Hz	26 x 4014 SMD LED	4W	8W	480 Lm	4000K	PC	120°	max 100W
<b>RS8-8W</b>	220V-240V ~ 50/60 Hz	48 x 4014 SMD LED	8W	13W	960 Lm	4000K	PC	120°	max 100W
<b>RS10-10W</b>	220V-240V ~ 50/60 Hz	70 x 4014 SMD LED	10W	21W	1200 Lm	4000K	PC	120°	max 100W
<b>RS14-14W</b>	220V-240V ~ 50/60 Hz	90 x 4014 SMD LED	14W	28W	1680 Lm	4000K	PC	120°	max 100W

**Descrizione / Description / Description / Descripción / Beschreibung:**

Lampada sottopensile LED - Ideali per sostituire le vecchie reglette fluo T5. Con interruttore LED cabinet light - Ideal substitute to the old style T5 neon barlights. With switch  
Réglettes LED - Idéales pour la substitution des vieilles réglettes au néon de type T5. Avec interrupteur on-off  
Regletas led - Ideal para sustituir las regletas mas antiguas con tubos  
LED-Unterbauleuchte - Ideal als Ersatz für die alten Leuchten vom Typ T5. Mit Ein- und Ausschalter

**Accessori inclusi / Accessories included / Accessoires fournis / Accesorios incluidos / Mitgeliefertes Zubehör:**



**Kit di installazione**  
Installation kit

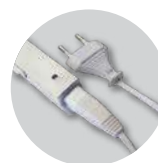

**Cavo di alimentazione**  
Power cable 150 cm



**Cavo di connessione**  
Connector 15 cm

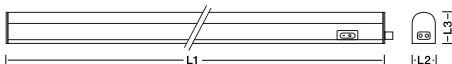

Codice Prodotto Item code Code Codigo Code	Lunghezza L1 Length Longueur Longitud Länge	Larghezza L2 Width Largeur Ancho Breite	Altezza L3 Height Hauteur Altura Höhe	Imballo Packing Emballage Embalaje Verpackung	Inner Pcs	Master Pcs
<b>RS4-4W</b>	313 mm	22 mm	30 mm	Colour box	10	30
<b>RS8-8W</b>	573 mm	22 mm	30 mm	Colour box	10	30
<b>RS10-10W</b>	873 mm	22 mm	30 mm	Colour box	10	30
<b>RS14-14W</b>	1173 mm	22 mm	30 mm	Colour box	10	30

**RS4-4W**



**RS8-8W**



**RS10-10W**



**RS14-14W**



## REGLETTE LED

LED bar lights / Réglettes LED / Regletas de LED / LED-Linienlampen

# PLAFONIERA PER TUBI LED T8



ONLY FOR  
LED TUBES

Indoor lighting



Protection  
class



Tubes  
not included



PI20258

Codice Prod. Item code Code Codigo Code	Alimentazione Power source Alimentation Alimentación Stromversorgung	Tecnologia della Luce Light technology Technologie de la lumière tecnología de iluminación Beleuchtungstechnologie	Formato Format Format Formato Format	Attacco Lamp holder Culot Ataco Halterung	Materiale Material Materiau Material Material
PI20258	220V-240V ~ 50 Hz	2 LED tubes 150 cm (not included)	T8	G13	Metal

### Descrizione / Description / Description / Descripción / Beschreibung:

Plafoniera da interno da usare esclusivamente con tubi LED T8.  
Prodotto senza alimentazione  
Light fitting for indoor use, compatible with T8 LED tube  
Item without power supply  
Réglette T8 pour usage intérieur, compatible exclusivement avec tubes LED.  
Produit fourni sans alimentation  
Regleta T8 para uso en interiores, sólo es compatible con tubos LED  
Producto suministrado sin alimentación  
Deckenleuchte T8 für den Innenbereich, nur mit LED Röhren T8 zu verwenden.  
Produkt ohne Stromzufuhr.

### Accessori inclusi / Accessories included / Accessoires fournis / Accesorios incluidos / Mitgeliefertes Zubehör:

Codice Prodotto Item code Code Codigo Code	Lunghezza L1 Length Longueur Lungitud Länge	Larghezza L2 Width Largeur Ancho Breite	Altezza L3 Height Hauteur Altura Höhe	Imballo Packing Emballage Embalaje Verpackung	Inner Pces	Master Pces
PI20258	1530 mm	102 mm	74 mm	Shrink	-	8



PI20258



## ICEBERG

Indoor lighting

**4000K**  
 COOL WHITE  
 LUCE NEUTRA

**3000K**  
 WARM LIGHT  
 LUCE CALDA

LED

38W



PANLEDO5-4000K



PANLEDO5-3000K



CRI &gt;80



25,000 hrs



Not Dimmable



Protection class



Insulation class



Containing product



intertek



Flicker-free



Codice Prodotto Item code Code Codigo Code	Alimentazione Power source Alimentation Alimentación Stromversorgung	Tecnologia della Luce Light technology Technologie de la lumière Tecnología de iluminación Beleuchtungstechnologie	Potenza (W) Watt power Puissance Potencia Leistung	Lumen Lumen Lumen Lumen	Tipo di luce Kelvin degrees Degrés Kelvin Temperatura de luz °K	Apertura Fascio Kind of beam Type de faisceau Tipo de haz Ausstrahlungswinkel	Materiale Material Materiu Material Material
PANLEDO5-4000K	220V-240V ~ 50/60 Hz	SMD 2835 LED	38W	3800 Lm	4000K	120° Diffuse	AL
PANLEDO5-3000K	220V-240V ~ 50/60 Hz	SMD 2835 LED	38W	3800 Lm	3000K	120° Diffuse	AL

## Descrizione / Description / Description / Descripción / Beschreibung:

Pannello LED da soffitto 60 x 60 cm - Backlight technology  
 60 x 60 cm LED panel (Backlight technology)  
 Panneau LED 60 x 60 cm (Backlight technology)  
 Panel LED para techo 60 x 60 cm (Backlight technology)  
 Decken-LED-Panel 60 x 60 cm (Backlight technology)

## Accessori inclusi / Accessories included / Accessoires fournis / Accesorios incluidos / Mitgeliefertes Zubehör:

Driver incluso  
 Driver Included  
 Driver fourni  
 Driver incluido  
 Driver inbegriffen

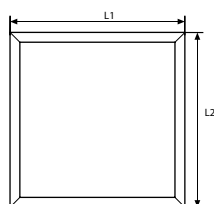
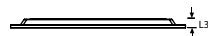

Codice Prodotto Item code Code Codigo Code	Lunghezza L1 Length Longueur Lungitud Länge	Larghezza L2 Width Largeur Ancho Breite	Altezza L3 Height Hauteur Altura Höhe	Imballo Packing Emballage Embalaje Verpackung	Inner Pcs	Master Pcs
PANLEDO5-4000K	595	595	32	Colour box	-	5
PANLEDO5-3000K	595	595	32	Colour box	-	5

PANLEDO5-4000K



PANLEDO5-3000K



# PANNELLI LED

LED panels / Panneaux LED / Paneles de LED / LED-panels

## ICEBERG



**4000K**  
COOL WHITE  
LUCE NEUTRA

**UGR<19**  
UNIFIED GLARE RATING



PANUGR-4000K



CRI >80



25,000 hrs



Not Dimmable



Protection class



Insulation class



Containing product



Codice Prodotto Item code Code Codigo Code	Alimentazione Power source Alimentation Alimentación Stromversorgung	Tecnologia della Luce Light technology Technologie de la lumière Tecnología de iluminación Beleuchtungstechnologie	Potenza (W) Watt power Puissance Potencia Leistung	Lumen Lumen Lumen Lumen Lumen	Tipo di luce Kelvin degrees Degrés Kelvin Temperatura de luz °K	Apertura Fascio Kind of beam Type de faisceau Tipo de haz Ausstrahlungswinkel	Materiale Material Materiau Material Material
PANUGR-4000K	220V-240V ~ 50/60 Hz	SMD 2835 LED	38W	3800 Lm	4000K	120° Diffuse	AL

### Descrizione / Description / Description / Descripción / Beschreibung:

Pannello LED da soffitto 60 x 60 cm - Backlight technology  
60 x 60 cm LED panel (Backlight technology)  
Panneau LED 60 x 60 cm (Backlight technology)  
Panel LED para techo 60 x 60 cm (Backlight technology)  
Decken-LED-Panel 60 x 60 cm (Backlight technology)

### Accessori inclusi / Accessories included / Accessoires fournis / Accesorios incluidos / Mitgeliefertes Zubehör:

Driver incluso  
Driver Included  
Driver fourni  
Driver incluido  
Driver inbegriffen

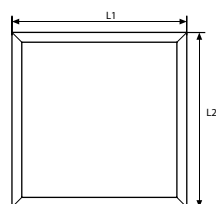
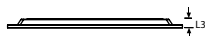

Codice Prodotto Item code Code Codigo Code	Lunghezza L1 Length Longueur Lungitud Länge	Larghezza L2 Width Largeur Ancho Breite	Altezza L3 Height Hauteur Altura Höhe	Imballo Packing Emballage Embalaje Verpackung	Inner Pces	Master Pces
PANUGR-4000K	595	595	32	Colour box	-	5

PANUGR-4000K





# MOON



Ø  
**29cm**

**20W**

ONLY  
65 mm  
**SLIM**



PTLED20W



CRI ≥80



25.000 hrs



Not Dimmable



Protection class



Insulation class



Containing product



Codice Prodotto Item code Code Codigo Code	Alimentazione Power source Alimentation Alimentación Stromversorgung	Tecnologia della Luce Light technology Technologie de la lumière Tecnología de iluminación Beleuchtungstechnologie	Potenza (W) Watt power Puissance Potencia Leistung	Lumen Lumen Lumen Lumen	Tipo di luce Kelvin degrees Degrés Kelvin Temperatura de luz °K	Apertura Fascio Kind of beam Type de faisceau Tipo de haz Ausstrahlungswinkel	Materiale Material Materiau Material Material
<b>PTLED20W</b>	220V-240V ~ 50/60 Hz	SMD 2835 LED	20W	1400 Lm	4000K	Diffuse 120°	MS + Metal

**Descrizione** / Description / Description / Descripción / Beschreibung:

Plafoniera LED tonda con diffusore in plastica  
LED round ceiling lamp with plastic diffuser  
Plafonnier LED rond, diffuseur en plastique  
Plafón LED circular, material difusor; plástico  
LED Deckenleuchte, rund, mit Diffusor aus Kunststoff

**Accessori inclusi** / Accessories included / Accessoires fournis / Accesorios incluidos / Mitgeliefertes Zubehör:

Driver incluso  
Driver Included  
Driver fourni  
Driver incluido  
Driver inbegriffen

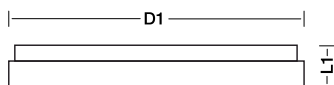

Codice Prodotto Item code Code Codigo Code	Diametro D1 Diameter Diamètre Diámetro Breite	Altezza L1 Height Hauteur Altura Höhe	Imballo Packing Emballage Embalaje Verpackung	Inner Pcs	Master Pcs
<b>PTLED20W</b>	29 cm	6,5 cm	Colour box	5	10

PTLED20W



# PLAFONIERE LED TONDE

LED ceiling lamps / Plafonniers à LED intégrées / Plafon LED / LED-Deckenlampe



Indoor lighting

## MOON XL



PTLED32W



CRI ≥80



25.000 hrs



Not Dimmable



Protection class



Insulation class



Containing product



Codice Prodotto Item code Code Codigo Code	Alimentazione Power source Alimentation Alimentación Stromversorgung	Tecnologia della Luce Light technology Technologie de la lumière Tecnología de iluminación Beleuchtungstechnologie	Potenza (W) Watt power Puissance Potencia Leistung	Lumen Lumen Lumen Lumen Lumen	Tipo di luce Kelvin degrees Degrés Kelvin Temperatura de luz °K	Apertura Fascio Kind of beam Type de faisceau Tipo de haz Ausstrahlungswinkel	Materiale Material Materiu Material Material
PTLED32W	220V-240V ~ 50/60 Hz	SMD 2835 LED	32W	2400 Lm	4000K	Diffuse 120°	MS + Metal

### Descrizione / Description / Description / Descripción / Beschreibung:

Plafoniera LED tonda con diffusore in plastica  
 LED round ceiling lamp with plastic diffuser  
 Plafonnier LED rond, diffuseur en plastique  
 Plafón LED circular, material difusor: plástico  
 LED Deckenleuchte, rund, mit Diffusor aus Kunststoff

### Accessori inclusi / Accessories included / Accessoires fournis / Accesorios incluidos / Mitgeliefertes Zubehör:

Driver incluso  
 Driver Included  
 Driver fourni  
 Driver incluido  
 Driver inbegriffen

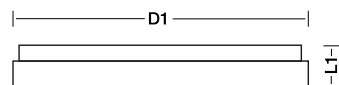

Codice Prodotto Item code Code Codigo Code	Diametro D1 Diameter Diamètre Diámetro Breite	Altezza L1 Height Hauteur Altura Höhe	Imballo Packing Emballage Embalaje Verpackung	Inner Pces	Master Pces
PTLED32W	39 cm	6,5 cm	Colour box	5	10

PTLED32W





**DIMMABLE + COLOUR CHANGE**

**3000K**  
WARM LIGHT  
LUCE CALDA

**4000K**  
COOL WHITE  
LUCE NEUTRA

**6500K**  
COLD LIGHT  
LUCE FREDDA

**STARRY**



Ø  
**46cm**

**36W**

ONLY  
85 mm  
**SLIM**



STARRY



CRI ≥80



25.000 hrs



Not Dimmable



Protection class



Insulation class



Containing product



Codice Prodotto Item code Code Codigo Code	Alimentazione Power source Alimentation Alimentación Stromversorgung	Tecnologia della Luce Light technology Technologie de la lumière Tecnología de iluminación Beleuchtungstechnologie	Potenza (W) Watt power Puissance Potencia Leistung	Lumen Lumen Lumen Lumen Lumen	Tipo di luce Kelvin degrees Degrés Kelvin Temperatura de luz °K	Apertura Fascio Kind of beam Type de faisceau Tipo de haz Ausstrahlungswinkel	Materiale Material Materiau Material Material
<b>STARRY</b>	220V-240V ~ 50/60 Hz	SMD 2835 LED	36W	2600 Lm	3000K / 4000K / 6500K: CCT	Diffuse 120°	PMMA + Metal

**Descrizione** / Description / Description / Descripción / Beschreibung:

Plafoniera LED tonda con diffusore in PMMA  
LED round ceiling lamp with PMMA diffuser  
Plafonnier LED rond, diffuseur en PMMA  
Plafon LED circular, material difusor: PMMA  
LED Deckenleuchte, rund, mit Diffusor aus PMMA

**Accessori inclusi** / Accessories included / Accessoires fournis / Accesorios incluidos / Mitgeliefertes Zubehör:



**Telecomando**

Remote control  
(2 x AAA batterie incluse / batteries included)

**Driver incluso**

Driver included

Codice Prodotto Item code Code Codigo Code	Diametro D1 Diameter Diamètre Diámetro Breite	Altezza L1 Height Hauteur Altura Höhe	Imballo Packing Emballage Embalaje Verpackung	Inner Pces	Master Pces
<b>STARRY</b>	46 cm	8,5 cm	Colour box	2	6

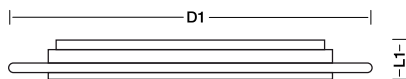

STARRY







## SIRIO



PT310



PT330



PT340



Protection class



Insulation class



Codice Prodotto Item code Code Codigo Code	Alimentazione Power source Alimentation Alimentación Stromversorgung	Tecnologia della Luce Light technology Technologie de la lumière Tecnología de iluminación Beleuchtungstechnologie	Potenza (W) Watt power Puissance Potencia Leistung	Apertura Fascio Kind of beam Type de faisceau Tipo de haz Ausstrahlungswinkel	Materiale Material Materiau Material Material
PT310	220V-240V ~ 50/60 Hz	1 x E27	Max 40W	Diffuse 120°	Glass + Metal
PT330	220V-240V ~ 50/60 Hz	1 x E27	Max 40W	Diffuse 120°	Glass + Metal
PT340	220V-240V ~ 50/60 Hz	2 x E27	2 x Max 40W	Diffuse 120°	Glass + Metal

Descrizione / Description / Description / Descripción / Beschreibung:

Plafoniera tonda con diffusore in alabastro  
 Round ceiling lamp with alabaster diffuser  
 Plafonnier rond, diffuseur en alabâtre  
 Plafón circular, material difusor: alabastro  
 Deckenleuchte, rund, mit Diffusor aus Alabaste

Accessori inclusi / Accessories included / Accessoires fournis / Accesorios incluidos / Mitgeliefertes Zubehör:

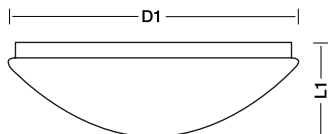

Codice Prodotto Item code Code Codigo Code	Diametro D1 Diameter Diamètre Diámetro Breite	Altezza L1 Height Hauteur Altura Höhe	Imballo Packing Emballage Embalaje Verpackung	Inner Pcs	Master Pcs
PT310	30 cm	8,5 cm	Colour box	-	5
PT330	30 cm	8,5 cm	Colour box	-	10
PT340	40 cm	11 cm	Colour box	-	5

PT310



PT330



PT340





## SAPHIR



Protection class



Insulation class



Codice Prodotto Item code Code Codigo Code	Alimentazione Power source Alimentation Alimentación Stromversorgung	Tecnologia della Luce Light technology Technologie de la lumière Tecnología de iluminación Beleuchtungstechnologie	Potenza (W) Watt power Puissance Potencia Leistung	Apertura Fascio Kind of beam Type de faisceau Tipo de haz Ausstrahlungswinkel	Materiale Material Materiu Material Material
PT313	220V-240V ~ 50/60 Hz	1 x E27	Max 40W	Diffuse 120°	Glass + Metal
PT333	220V-240V ~ 50/60 Hz	1 x E27	Max 40W	Diffuse 120°	Glass + Metal
PT343	220V-240V ~ 50/60 Hz	2 x E27	2 x Max 40W	Diffuse 120°	Glass + Metal

Descrizione / Description / Description / Descripción / Beschreibung:

Plafoniera tonda con diffusore in vetro satinato  
 Round satin glass ceiling light  
 Plafonnier rond, diffuseur en verre satiné  
 Plafón de techo redondo con difusor de vidrio esmerilado  
 Runde Deckenleuchte in Milchglas mit Diffusor

Accessori inclusi / Accessories included / Accessoires fournis / Accesorios incluidos / Mitgeliefertes Zubehör:

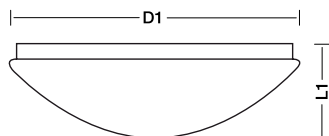

Codice Prodotto Item code Code Codigo Code	Diametro D1 Diameter Diamètre Diámetro Breite	Altezza L1 Height Hauteur Altura Höhe	Imballo Packing Emballage Embalaje Verpackung	Inner Pcs	Master Pcs
PT313	30 cm	8,5 cm	Colour box	-	5
PT333	30 cm	8,5 cm	Colour box	-	10
PT343	40 cm	11 cm	Colour box	-	5

PT313



PT333



PT343



# PLAFONIERE TONDE

Ceiling lamps / Plafonniers / Plafon / Deckenlampe

## SAPHIR



30cm



40cm



PT363



PT373



Protection class



Insulation class



Codice Prodotto Item code Code Codigo Code	Alimentazione Power source Alimentation Alimentación Stromversorgung	Tecnologia della Luce Light technology Technologie de la lumière Tecnología de iluminación Beleuchtungstechnologie	Potenza (W) Watt power Puissance Potencia Leistung	Apertura Fascio Kind of beam Type de faisceau Tipo de haz Ausstrahlungswinkel	Materiale Material Materiau Material Material
PT363	220V-240V ~ 50/60 Hz	1 x E27	Max 40W	Diffuse 120°	Glass + Metal
PT373	220V-240V ~ 50/60 Hz	2 x E27	Max 2 x 40W	Diffuse 120°	Glass + Metal

**Descrizione** / Description / Description / Descripción / Beschreibung:

Plafoniera quadrata con diffusore in vetro satinato  
 Square satin glass ceiling light  
 Plafonnier carré, diffuseur en verre satiné  
 Plafón de techo cuadrado con difusor de vidrio esmerilado  
 Quadratische Deckenleuchte in satiniertem Glas mit Diffusor

**Accessori inclusi** / Accessories included / Accessoires fournis / Accesorios incluidos / Mitgeliefertes Zubehör:

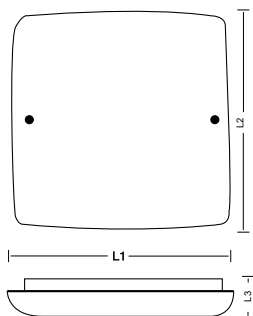

Codice Prodotto Item code Code Codigo Code	Lunghezza L1 Length Longueur Lungitud Länge	Larghezza L2 Width Largeur Ancho Breite	Altezza L3 Height Hauteur Altura Höhe	Imballo Packing Emballage Embalaje Verpackung	Inner Pces	Master Pces
PT363	30 cm	30 cm	9 cm	Colour box	-	5
PT373	40 cm	40 cm	10,5 cm	Colour box	-	5

PT363



PT373





**VEGA**



PT331



Protection class



Insulation class



Codice Prodotto Item code Code Codigo Code	Alimentazione Power source Alimentation Alimentación Stromversorgung	Tecnologia della Luce Light technology Technologie de la lumière Tecnología de iluminación Beleuchtungstechnologie	Potenza (W) Watt power Puissance Potencia Leistung	Apertura Fascio Kind of beam Type of faisceau Tipo de haz Ausstrahlungswinkel	Materiale Material Materiau Material Material
<b>PT331</b>	220V-240V ~ 50/60 Hz	1 x E27	Max 40W	Diffuse 120°	Glass + Metal

**Descrizione** / Description / Description / Descripción / Beschreibung:

Plafoniera tonda con diffusore in vetro  
Round ceiling lamp with glass diffuser  
Plafonnier rond, diffuseur en verre  
Plafon circular, material difusor: cristal  
Deckenleuchte, rund, mit Diffusor aus Glas

**Accessori inclusi** / Accessories included / Accessoires fournis / Accesorios incluidos / Mitgeliefertes Zubehör:

Codice Prodotto Item code Code Codigo Code	Diámetro D1 Diameter Diamètre Diámetro Breite	Altezza L1 Height Hauteur Altura Höhe	Imballo Packing Emballage Embalaje Verpackung	Inner Pces	Master Pces
<b>PT331</b>	30 cm	10 cm	Colour box	-	10

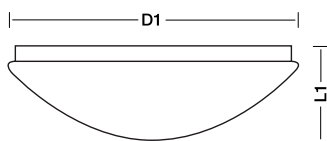

# PLAFONIERE TONDE

Ceiling lamps / Plafonniers / Plafon / Deckenlampe

## MIRA



PT342



Protection class



Insulation class



Indoor lighting

Codice Prodotto Item code Code Codigo Code	Alimentazione Power source Alimentation Alimentación Stromversorgung	Tecnologia della Luce Light technology Technologie de la lumière Tecnología de iluminación Beleuchtungstechnologie	Potenza (W) Watt power Puissance Potencia Leistung	Apertura Fascio Kind of beam Type de faisceau Tipo de haz Ausstrahlungswinkel	Materiale Material Materiu Material Material
<b>PT342</b>	220V-240V ~ 50/60 Hz	2 x E27	Max 2 x 40W	Diffuse 120°	Glass + Metal

**Descrizione** / Description / Description / Descripción / Beschreibung:

Plafoniera tonda con diffusore in vetro  
 Round ceiling lamp with glass diffuser  
 Plafonnier rond, diffuseur en verre  
 Pláfon circular, material difusor: cristal  
 Deckenleuchte, rund, mit Diffusor aus Glas

**Accessori inclusi** / Accessories included / Accessoires fournis / Accesorios incluidos / Mitgeliefertes Zubehör:

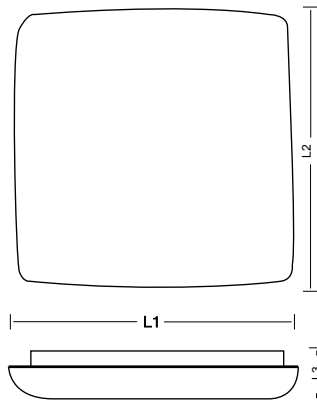

Codice Prodotto Item code Code Codigo Code	Lunghezza L1 Length Longueur Lungitud Länge	Larghezza L2 Width Largeur Ancho Breite	Altezza L3 Height Hauteur Altura Höhe	Imballo Packing Emballage Embalaje Verpackung	Inner Pces	Master Pces
<b>PT342</b>	43 cm	43 cm	10,5 cm	Colour box	-	5

PT342





## APOLUX - Pendant



SPH167



Protection class



Insulation class



Globe not included



Bulb not included



Codice Prodotto Item code Code Codigo Code	Alimentazione Power source Alimentation Alimentación Stromversorgung	Attacco Lamp holder Culot Ataco Halterung	Potenza (W) Watt power Puissance Potencia Leistung	Cavo Cable Cable Cable Kabel	Materiale Material Materiau Material Material	Imballo Packing Emballage Embalaje Verpackung	Inner Pces	Master Pces
SPH167	220V-240V ~ 50 Hz	E27	max 60W	100 cm, H03VV-F 2x0.75mm <sup>2</sup>	PP	Polybag	6	24

## Descrizione / Description / Description / Descripción / Beschreibung:

Sospensioni in metallo per lampade E27  
 E27 metal pendant lamp holders  
 Suspensions métallique pour ampoule E27  
 Suspensiones metálicas para lámparas E27  
 Metallaufhängungen für E27-Lampen

ø10 cm

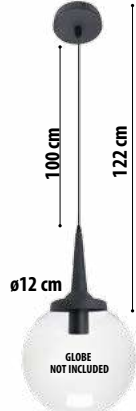

SPH167



8 003910 107908 &gt;

## APOLUX - Sfere



SPH251-U



SPH251-Y



SPH251-K



Bulb  
not included



Codice Prodotto Item code Code Codigo Code	Colore Colour Couleur Color Farbe	Materiale Material Materiau Material Material	Diametro D1 Width Largeur Ancho Breite	Altezza L1 Height Hauteur Altura Höhe	Imballo Packing Emballage Embalaje Verpackung	Inner Pces	Master Pces
SPH251-U	Blue	PMMA	250 mm	260 mm	Polybag	-	6
SPH251-Y	Yellow	PMMA	250 mm	260 mm	Polybag	-	6
SPH251-K	Pink	PMMA	250 mm	260 mm	Polybag	-	6

## Descrizione / Description / Description / Descripción / Beschreibung:

Sfera per interni ed esterni in PMMA  
Sphere for interiors and exteriors in PMMA  
Sphère pour intérieurs et extérieurs en PMMA  
Esfera para interiores y exteriores en PMMA  
Sphäre für Innen- und Außenbereiche in PMMA

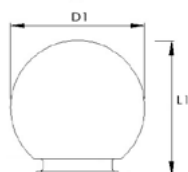



# SWAN 2



TL1602-B

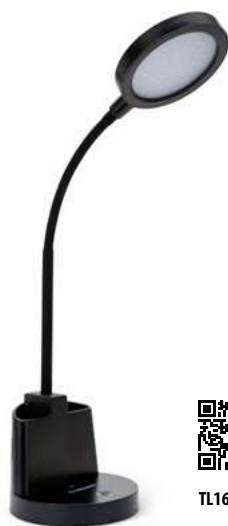

TL1602-N



CRI > 80



20.000 hrs



With adaptor



Insulation class



Containing product



intertek

Codice Prodotto Item code Code Codigo Code	Alimentazione Power source Alimentation Alimentación Stromversorgung	Tecnologia della Luce Light technology Technologie de la lumière Tecnología de iluminación Beleuchtungstechnologie	Potenza (W) Watt power Puissance Potencia Leistung	Lumen Lumen Lumen Lumen	Apertura Fascio Kind of beam Type de faisceau Tipo de haz Ausstrahlungswinkel	Tipo di luce Kelvin degrees Degrés Kelvin Temperatura de luz °K	Materiale Material Materiu Material Material
TL1602-B	230V ~ 50/60 Hz	2835 LED SMD	8W	510 Lm	Diffuse light	4000K	ABS
TL1602-N	230V ~ 50/60 Hz	2835 LED SMD	8W	510 Lm	Diffuse light	4000K	ABS

Descrizione / Description / Description / Descripción / Beschreibung:

Accessori inclusi / Accessories included / Accessoires fournis / Accesorios incluidos / Mitgeliefertes Zubehör:

Lampada da scrivania LED 7W con interruttore touch e portapenne  
 7W LED desk lamp with touch switch and pen holder  
 Lampe de bureau LED 7W avec interrupteur tactile et porte-CRAYONS  
 Lámpara de escritorio LED de 7W con interruptor táctil y portalápices  
 7W LED-Schreibtischlampe mit Touch-Schalter und Stifthalter



Adattatore  
Adaptor  
Adaptateur  
Adaptador  
Adapter

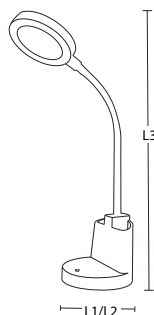

Codice Prodotto Item code Code Codigo Code	Lunghezza L1 Length Longueur Lungitud Länge	Larghezza L2 Width Largeur Ancho Breite	Altezza L3 Height Hauteur Altura Höhe	Imballo Packing Emballage Embalaje Verpackung	Inner Pcs	Master Pcs
TL1602-B	130 mm	130 mm	525 mm	Colour box	-	6
TL1602-N	130 mm	130 mm	525 mm	Colour box	-	6





# LAMPADE DA TAVOLO

Desk lamps / Lampes de bureau LED / Lampara de sobremesa con LED / Tischlampe

## SLIM



Indoor lighting



TL1606B



TL1606N



Dimmable



CRI > 80



30.000 hrs



With adaptor



Insulation class



Containing product



intertek



Codice Prodotto	Alimentazione	Tecnologia della Luce	Potenza (W)	Lumen	Apertura Fascio	Tipo di luce	Materiale
Item code Code Codigo Code	Power source Alimentation Alimentación Stromversorgung	Light technology Technologie de la lumière Tecnología de iluminación Beleuchtungstechnologie	Watt power Puissance Potencia Leistung	Lumen Lumen Lumen Lumen	Kind of beam Type de faisceau Tipo de haz Ausstrahlungswinkel	Kelvin degrees Degrés Kelvin Temperatura de luz °K	Material Materiu Material Material
<b>TL1606B</b>	100-240V ~ 50 Hz / 12V === 420mA	LED SMD	6W	510 Lm	Diffuse light	4000K	ABS
<b>TL1606N</b>	100-240V ~ 50 Hz / 12V === 420mA	LED SMD	6W	510 Lm	Diffuse light	4000K	ABS

Descrizione / Description / Description / Descripción / Beschreibung:

Lampada da tavolo LED 6W  
6W Desk lamp  
Lampe de bureau LED 6W  
Lampara de sobremesa con LED 6W  
LED-Tischlampe 6W

Accessori inclusi / Accessories included / Accessoires inclus / Accesorios incluidos / Mitgeliefertes Zubehör:



Adattatore  
Adaptor  
Adaptateur  
Adaptador  
Adapter

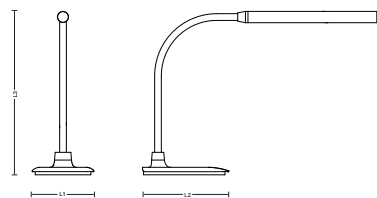

Codice prod.	Lunghezza L1	Larghezza L2	Altezza L3	Imballo	Inner Pcs	Master Pcs
Item code Code Codigo	Length Longueur Lungitud Länge	Width Largeur Ancho Breite	Height Hauteur Altura Höhe	Packing Emballage Embalaje Verpackung		
<b>TL1606B</b>	120 mm	167 mm	380 mm, max 695 mm	Colour box	4	24
<b>TL1606N</b>	120 mm	167 mm	380 mm, max 695 mm	Colour box	4	24





Indoor lighting

LAMPADIE DA TAVOLO

Desk lamps / Lampes de bureau LED / Lampara de sobremesa con LED / Tischlampe

## DROID 2



CRI > 80



25.000 hrs



With adaptor



Insulation class



Containing product



Codice Prodotto Item code Code Codigo Code	Alimentazione Power source Alimentation Alimentación Stromversorgung	Tecnologia della Luce Light technology Technologie de la lumière Tecnología de iluminación Beleuchtungstechnologie	Potenza (W) Watt power Puissance Potencia Leistung	Lumen Lumen Lumen Lumen	Apertura Fascio Kind of beam Type de faisceau Tipo de haz Ausstrahlungswinkel	Tipo di luce Kelvin degrees Degrés Kelvin Temperatura de luz °K	Materiale Material Materiu Material Material
<b>TL1614</b>	100-240V ~ 50 Hz / 12V === 420mA	LED SMD	7W	530 Lm	Diffuse light	3000K - 4000K - 6500K	ABS+AL

**Descrizione** / Description / Description / Descripción / Beschreibung:

Lampada da tavolo LED 7W  
7W Desk lamp  
Lampe de bureau LED 7W  
Lampara de sobremesa con LED 7W  
LED-Tischlampe 7W

**Accessori inclusi** / Accessories included / Accessoires fournis / Accesorios incluidos / Mitgeliefertes Zubehör:



Adattatore  
Adaptor  
Adaptateur  
Adaptador  
Adapter

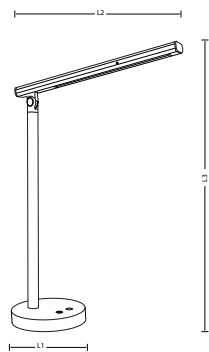

Codice Prodotto Item code Code Codigo Code	Lunghezza L1 Length Longueur Lungitud Länge	Larghezza L2 Width Largeur Ancho Breite	Altezza L3 Height Hauteur Altura Höhe	Imballo Packing Emballage Embalaje Verpackung	Inner Pcs	Master Pcs
<b>TL1614</b>	140 mm	300 mm	320 mm	Colour box	4	24

TL1614



# SPOT LED CON CLIP

LED Spot with clip / Spot LED avec clip / Faro LED con clip / LED Spot mit Clip

## CHARLY

LED



TL1401-B



TL1401-N



CRI > 80



30.000 hrs



Insulation class



Switch



Energy class

Codice Prodotto Item code Code Codigo Code	Alimentazione Power source Alimentation Alimentación Stromversorgung	Tecnologia della Luce Light technology Technologie de la lumière Tecnología de iluminación Beleuchtungstechnologie	Potenza (W) Watt power Puissance Potencia Leistung	Lumen Lumen Lumen Lumen Lumen	Apertura Fascio Kind of beam Type de faisceau Tipo de haz Ausstrahlungswinkel	Tipo di luce Kelvin degrees Degrés Kelvin Temperatura de luz °K	Cavo Cable Câble Cable Kabel	Materiale Material Materiu Material Material
TL1401-B	220-240V ~ 50 Hz	24 LED SMD 2835	4.8W	360	Diffuse	3000K	180 mm	ABS / Metal
TL1401-N	220-240V ~ 50 Hz	24 LED SMD 2835	4.8W	360	Diffuse	3000K	180 mm	ABS / Metal

Descrizione / Description / Description / Descripción / Beschreibung:

Spot LED con clip  
LED Spot with clip  
Spot LED avec clip  
Faro LED con clip  
LED Spot mit Clip

Accessori inclusi / Accessories included / Accessoires fournis / Accesorios incluidos / Mitgeliefertes Zubehör:



Interruttore + cavo  
Switch + cable  
Interrupteur + câble  
Conmutador + cable  
Schalter + kabel



Clip

Codice Prodotto Item code Code Codigo Code	Lunghezza L1 Length Longueur Lungitud Länge	Larghezza L2 Width Largeur Ancho Breite	Altezza L3 Height Hauteur Altura Höhe	Imballo Packing Emballage Embalaje Verpackung	Inner Pces	Master Pces
TL1401-B	90	70	150	Colour box	6	24
TL1401-N	90	70	150	Colour box	6	24

TL1401-B



TL1401-N

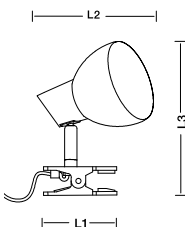



# MUSHROOM



TL1010-B



Insulation class



Bulb not included



Switch



intertek

Codice Prodotto Item code Code Codigo Code	Alimentazione Power source Alimentation Alimentación Stromversorgung	Attacco Lamp holder Culot Ataco Halterung	Cavo Cable Câble Cable Kabel	Materiale Material Materiau Material Material	Lunghezza L1 Length Longueur Lungitud Länge	Larghezza L2 Width Largeur Ancho Breite	Altezza L3 Height Hauteur Altura Höhe	Imballo Packing Emballage Embalaje Verpackung	Inner Pcs	Master Pcs
TL1010-B	230V ~ 50Hz	E14 (MAX 15W)	150 cm	ABS	160 mm	160 mm	25.5mm	Shrink	-	6

**Descrizione** / Description / Description / Descripción / Beschreibung:

Lampada da tavolo  
Desk lamp  
Lampe de bureau  
Lampara de sobremesa  
Tischlampe

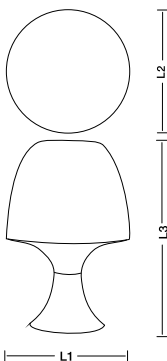

**Accessori inclusi** / Accessories included / Accessoires fournis / Accesorios incluidos / Mitgeliefertes Zubehör:



Interruttore + cavo  
Switch + cable  
Interrupteur + câble  
Conmutador + cable  
Schalter + kabel

TL1010-B



# LAMPADE DA TAVOLO

Desk lamps / Lampes de bureau / Lampara de sobremesa / Tischlampe

## CHARLESTON



TL1201-B



TL1201-N



TL1201-U



TL1201-S



Indoor lighting



Insulation class



Bulb  
not included



Switch



intertek



Codice Prodotto Item code Code Codigo Code	Alimentazione Power source Alimentation Alimentación Stromversorgung	Attacco Lamp holder Culot Ataco Halterung	Cavo Cable Câble Cable Kabel	Materiale Material Materiau Material Material	Lunghezza L1 Length Longueur Lungitud Länge	Larghezza L2 Width Largeur Ancho Breite	Altezza L3 Height Hauteur Altura Höhe	Imballo Packing Emballage Embalaje Verpackung	Inner Pces	Master Pces
TL1201-B	220V ~ 50 Hz	E27	150 cm	Metal + ABS	115 mm	130 mm	325 mm	Colour box	-	12
TL1201-N	220V ~ 50 Hz	E27	150 cm	Metal + ABS	115 mm	130 mm	325 mm	Colour box	-	12
TL1201-U	220V ~ 50 Hz	E27	150 cm	Metal + ABS	115 mm	135 mm	370 mm	Colour box	-	12
TL1201-S	220V ~ 50 Hz	E27	150 cm	Metal + ABS	115 mm	135 mm	370 mm	Colour box	-	12

Descrizione / Description / Description / Descripción / Beschreibung:

Accessori inclusi / Accessories included / Accessoires fournis / Accesorios incluidos / Mitgeliefertes Zubehör:

Lampada da tavolo  
Desk lamp  
Lampe de bureau  
Lampara de sobremesa  
Tischlampe

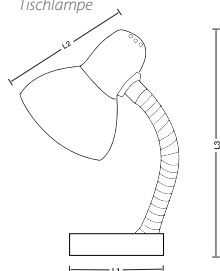

TL1201-B



TL1201-N



TL1201-U



TL1201-S





# CHARLESTON



Indoor lighting



TL1203-B



TL1203-N



Insulation class



Bulb  
not included



Switch



intertek

Codice Prodotto Item code Code Codigo Code	Alimentazione Power source Alimentación Alimentation Stromversorgung	Attacco Lamp holder Culot Ataco Halterung	Cavo Cable Câble Cable Kabel	Materiale Material Materiau Material Material	Lunghezza L1 Length Longueur Longitud Länge	Larghezza L2 Width Largeur Ancho Breite	Altezza L3 Height Hauteur Altura Höhe	Imballo Packing Emballage Embalaje Verpackung	Inner Pces	Master Pces
TL1203-B	220V ~ 50 Hz	E27	150 cm	Metal + ABS	115 mm	135 mm	370 mm	Colour box	-	12
TL1203-N	220V ~ 50 Hz	E27	150 cm	Metal + ABS	115 mm	135 mm	370 mm	Colour box	-	12

**Descrizione** / Description / Description / Descripción / Beschreibung:

Lampada da tavolo  
Desk lamp  
Lampe de bureau  
Lampara de sovremesa  
Tischlampe

**Accessori inclusi** / Accessories included / Accessoires fournis / Accesorios incluidos / Mitgeliefertes Zubehör:



Interruttore + cavo  
Switch + cable  
Interrupteur + câble  
Conmutador + cable  
Schalter + kabel

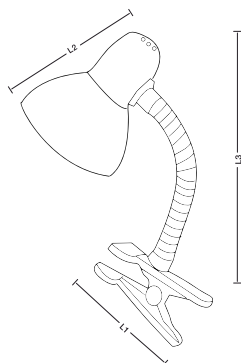

TL1203-B



TL1203-N



# LAMPADE DA TAVOLO

Desk lamps / Lampes de bureau / Lampara de sovremesa / Tischlampe

## CHARLESTON



Indoor lighting



Insulation class



Bulb not included



Switch



intertek



TL1207-N

Codice Prodotto Item code Code Codigo Code	Alimentazione Power source Alimentation Alimentación Stromversorgung	Attacco Lamp holder Culot Ataco Halterung	Cavo Cable Câble Cable Kabel	Materiale Material Materiau Material Material	Lunghezza L1 Length Longueur Lungitud Länge	Larghezza L2 Width Largeur Ancho Breite	Altezza L3 Height Hauteur Altura Höhe	Imballo Packing Emballage Embalaje Verpackung	Inner Pces	Master Pces
TL1207-N	220V ~ 50 Hz	E27	150 cm	Metal + ABS	115 mm	130 mm	325 mm	Colour box	-	6

Descrizione / Description / Description / Descripción / Beschreibung:

Lampada da tavolo  
Desk lamp  
Lampe de bureau  
Lampara de sovremesa  
Tischlampe

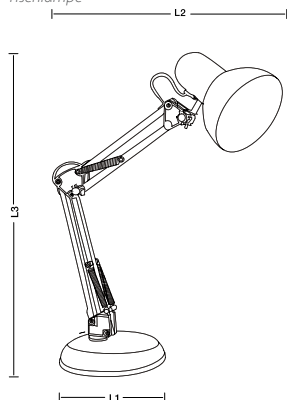

Accessori inclusi / Accessories included / Accessoires fournis / Accesorios incluidos / Mitgeliefertes Zubehör:



Interruttore + cavo  
Switch + cable  
Interrupteur + câble  
Commutador + cable  
Schalter + kabel

TL1207-N





# MAGNIFIER 4

Indoor lighting



10.000 hrs



on-off switch  
10.000



Not Dimmable



Insulation class



intertek



Energy class



Codice Prodotto Item code Code Codigo Code	Alimentazione Power source Alimentation Alimentación Stromversorgung	Tecnologia della Luce Light technology Technologie de la lumière Tecnología de iluminación Beleuchtungstechnologie	Potenza (W) Watt power Puissance Potencia Leistung	Lumen Lumen Lumen Lumen	Apertura Fascio Kind of beam Type de faisceau Tipo de haz Ausstrahlungswinkel	Tipo di luce Kelvin degrees Degrés Kelvin Temperatura de luz °K	Materiale Material Materiu Material Material
LE004LED	220V-240V ~ 50 Hz	30 x 0.2W SMD LED	6W	450 Lm	Diffuse light	6500K	PVC+Metal+Glass

Codice Prodotto Item code Code Codigo Code	Lunghezza L1 Length Longueur Lungitud Länge	Larghezza L2 Width Largeur Ancho Breite	Altezza L3 Height Hauteur Altura Höhe	Imballo Packing Emballage Embalaje Verpackung	Inner Pces	Master Pces
LE004LED	180 mm	180 mm	360 mm	Colour box	-	4

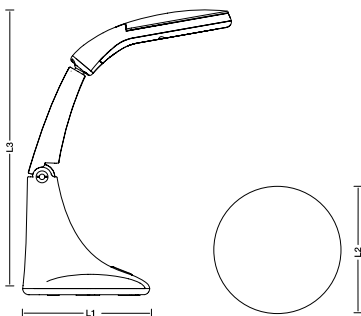

**Descrizione / Description / Description / Descripción / Beschreibung:**

Lampada con lente di ingrandimento 3-12 diottrie  
Magnifier lamp 3-12 diopter  
Lampe avec loupe 3-12 dioptries  
Lampara profesional con lupa, 3-12 dioptrias  
Lampe mit Vergrößerungsglas 3-12 Dioptrien

LE004LED





# LAMPADE CON LENTE

Magnifier lamps / Lampes avec loupe / Lamparas con lupa / Lupenleuchten

## LORD



25.000 hrs



Insulation class



Codice Prod. Item code Code Codigo Code	Alimentazione Power source Alimentation Alimentación Stromversorgung	Tecnologia della Luce Light technology Technologie de la lumière Tecnología de iluminación Beleuchtungstechnologie	Potenza (W) Watt power Puissance Potencia Leistung	Lumen Lumen Lumen Lumen	Apertura Fascio Kind of beam Type de faisceau Tipo de haz Ausstrahlungswinkel	Batteria Battery Batterie Batería Batterie	Autonomia Runtime Autonomie Autonomía Autonomie	Tipo di luce Kelvin degrees Degrés Kelvin Temperatura de luz °K	Materiale Material Materiau Material Material
LE008	5V --- 1A max	6 SMD LED	0.5W	60 Lm	Diffuse light	Battery: Li-Polymer 3,7V 400mAh	6 h	6000K	ABS

**Descrizione** / Description / Description / Descripción / Beschreibung:

Lampada LED con lente 3x/ 8x, ricaricabile  
LED lamp with 3x / 8x lens, rechargeable  
Lampe LED avec lentille 3x / 8x, rechargeable  
LED-Lampe mit 3X / 8X Linse, wiederaufladbar  
Lámpara LED con lente 3x / 8x, recargable

**Accessori inclusi** / Accessories included / Accessoires fournis / Accesorios incluidos / Mitgeliefertes Zubehör:



Cavo micro USB: 120 cm / USB cable: 120 cm

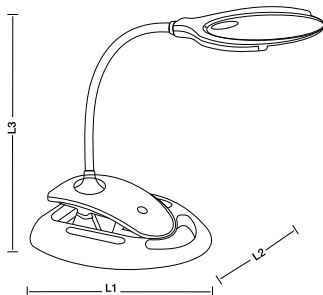

Codice Prodotto Item code Code Codigo Code	Lunghezza L1 Length Longueur Longitud Länge	Larghezza L2 Width Largeur Ancho Breite	Altezza L3 Height Hauteur Altura Höhe	Imballo Packing Emballage Embalaje Verpackung	Inner Pcs	Master Pcs
LE008	220 mm	135 mm	300 mm	Colour box	6	24

LE008





# TROOPER

Indoor lighting

2 LED

1.0X  
1.5X  
2.0X  
2.5X  
3.5X



25.000 hrs



Protection class



Codice Prod. Item code Code Codigo Code	Alimentazione Power source Alimentation Alimentación Stromversorgung	Tecnologia della Luce Light technology Technologie de la lumière Tecnología de iluminación Beleuchtungstechnologie	Potenza (W) Watt power Puissance Potencia Leistung	Lumen Lumen Lumen Lumen	Apertura Fascio Kind of beam Type de faisceau Tipo de haz Ausstrahlungswinkel	Batteria Battery Batterie Bateria Batterie	Autonomia Runtime Autonomie Autonomía Autonomie	Tipo di luce Kelvin degrees Degrés Kelvin Temperatura de luz °K	Materiale Material Materiau Material Material
LE035	Batteries	2 Standard LED	0.12W	12 Lm	Focus light	3 AAA/LR03 (not included)	24 h	6000K	ABS

**Descrizione** / Description / Description / Descripción / Beschreibung:

Occhiali LED con lente d'ingrandimento. 5 diottrie intercambiabili  
LED glasses with magnifying glass. 5 interchangeable diopters  
Lunettes LED avec loupe. 5 dioptries interchangeables  
Gafas LED con lupa. 5 dioptrías intercambiables  
LED-Brille mit Lupe. 5 austauschbare Dioptrien

**Accessori inclusi** / Accessories included / Accessoires fournis / Accesorios incluidos / Mitgeliefertes Zubehör:



5 Lenti / 5 Lens

1.0X - 1.5X - 2.0X - 2.5X - 3.5X

Banda elastica

Elastic band

Codice Prodotto Item code Code Codigo Code	Lunghezza L1 Length Longueur Lungitud Länge	Larghezza L2 Width Largeur Ancho Breite	Altezza L3 Height Hauteur Altura Höhe	Imballo Packing Emballage Embalaje Verpackung	Inner Pcs	Master Pcs
LE035	220	145	80	Colour box	6	48



LE035



## LAMPADE CONLENTE

Magnifier lamps / Lampes avec loupe / Lamparas con lupa / Lupenleuchten

# CROTALE



25.000 hrs



Insulation class



Codice Prod. Item code Code Codigo Code	Alimentazione Power source Alimentation Alimentación Stromversorgung	Tecnologia della Luce Light technology Technologie de la lumière Tecnología de iluminación Beleuchtungstechnologie	Potenza (W) Watt power Puissance Potencia Leistung	Lumen Lumen Lumen Lumen	Apertura Fascio Kind of beam Type de faisceau Tipo de haz Ausstrahlungswinkel	Batteria Battery Batterie Batería Batterie	Autonomia Runtime Autonomie Autonomía Autonomie	Tipo di luce Kelvin degrees Degrés Kelvin Temperatura de luz °K	Materiale Material Materiau Material Material
LE037	Batteries or 5V ~ 1A max	8 LED	0.4W	48 Lm	Diffuse light	3 x AAA/LR03 (not included)	30 h	6000K	ABS

**Descrizione** / Description / Description / Descripción / Beschreibung:

Lampada LED a mano o da tavolo con lente 5x/11x  
Hand and table LED lamp with 5x / 11x lens  
Lampe LED à main ou de table avec grossissement 5x / 11x  
Lampara LED de mano o de mesa con efecto lupa 5x / 11x  
Hand- und / oder Tisch-LED-Lampe mit 5x / 11x Linse

**Accessori inclusi** / Accessories included / Accessoires fournis / Accesorios incluidos / Mitgeliefertes Zubehör:



Cavo USB: 120 cm / USB cable: 120 cm



Codice Prodotto Item code Code Codigo Code	Lunghezza L1 Length Longueur Longitud Länge	Larghezza L2 Width Largeur Ancho Breite	Altezza L3 Height Hauteur Altura Höhe	Imballo Packing Emballage Embalaje Verpackung	Inner Pces	Master Pces
LE037	48 mm	195 mm	27 mm	Colour box	6	48

LE037



**IN287 - LINXLED**

Lente di ingrandimento 12 LED  
12 LED magnifying glass  
Loupe 12 LED  
Lupa con 12 LED  
Vergrößerungsglas 12 LED

IN287



x3



COD.									+	Packing	Inner Pcs	Master Pcs
<b>IN287</b>	12 LED SMD	15 Lm	N/S	12 hrs	Diffuse light	237 x 109 x 21,5 mm	2 x AA/LR6 (not included)	ABS	3 X Magnifier	Display 12 pcs	12	48

**IN288 - LINXLED**

Lente d'ingrandimento COB LED  
COB LED Magnifying glass  
Loupe COB LED  
Lupa de COB LED  
COB LED-Lupe

IN288



x3

COB LED



COD.									+	Packing	Inner Pcs	Master Pcs
<b>IN288</b>	COB LED	20 Lm	N/S	12 hrs	Diffuse light	237 x 109 x 21,5 mm	2 x AA/LR6 (not included)	ABS	3 X Magnifier	Display 12 pcs	12	48

**IN286 - WATSON**

Lente d'ingrandimento COB LED  
COB LED Magnifying glass  
Loupe COB LED  
Lupa de COB LED  
COB LED-Lupe

IN286



x3

COB LED

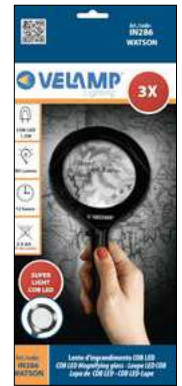

COD.									+	Packing	Inner Pcs	Master Pcs
<b>IN286</b>	COB LED	20 Lm	N/S	12 hrs	Diffuse light	237 x 109 x 21,5 mm	2 x AA/LR6 (not included)	ABS	3 X Magnifier	Colour box	12	48

## LUCI DA LETTURA

Reading lights / Lampes de lecture / Luces de lectura / Leselichter

### IN283 - LORD

Occhiali premontati da lettura  
Reading glasses  
Lunettes de lecture  
Gafas de lectura premontadas  
Vormontierte Lesebrille

+1.00

+1.50

+2.00

+2.50

+3.00

**5 DIOTTRIE A SCELTA**  
**5 DIOPTERS AVAILABLE**  
**5 DIOPTRIES AU CHOIX**  
**5 DIOPTRÍAS PARA ELEGIR**  
**5 DIOPTRIEN IHRER WAHL**

IN283



**4 COLORI A SCELTA**  
**4 COLOURS AVAILABLE**  
**4 COULEURS AU CHOIX**  
**4 COLORES PARA ELEGIR:**  
**4 FARBEN ZUR AUSWAHL**

COD.	Interpupillary distance	—	—	+	Packing	Inner Pcs	Master Pcs
IN283	62+/-1mm	131 x 136 x 22 mm	Glasses frame: Metal Lens: Acrylic	Folder	Display 20 pcs	20	240

### IN232 - GOOSE

Luce da lettura LED  
LED Booklight  
Lampe de lecture LED  
Luz de lectura LED  
LED-Leselampe



IN232



COD.	—	—	→	⌚	☀	—	—	—	Packing	Inner Pcs	Master Pcs
IN232	1 Super LED	6 Lm	N/S	13 hrs	Diffuse light	265 x 34 x 22 mm	2 x CR2016 (included)	ABS	Blister F2	12	72



**NEW**

**FAIRY**

**LED**



Insulation class



Rechargeable



IR236



Codice Prod. Item code Code Codigo Code	Alimentazione Power source Alimentation Alimentación Stromversorgung	Tecnologia della Luce Light technology Technologie de la lumière Tecnología de iluminación Beleuchtungstechnologie	Potenza (W) Watt power Puissance Potencia Leistung	Lumen Lumen Lumen Lumen	Apertura Fascio Kind of beam Type de faisceau Tipo de haz Ausstrahlungswinkel	Batteria Battery Batterie Bateria Batterie	Autonomia Runtime Autonomie Autonomía Autonomie	Tipo di luce Kelvin degrees Degrés Kelvin Temperatura de luz °K	Materiale Material Materiau Material Material
IR236	5V --- 1A max	COB LED	2W	150 Lm	Diffuse light	Li-Po 800 mAH (included)	6 hrs	4000K	ABS + AL

**Descrizione** / Description / Description / Descripción / Beschreibung:

Lampada da lettura COB LED ricaricabile  
 COB LED rechargeable reading lamp  
 Lampe de lecture rechargeable à COB LED  
 Lámpara de lectura recargable de COB LED  
 COB wiederaufladbare LED-Leselampe

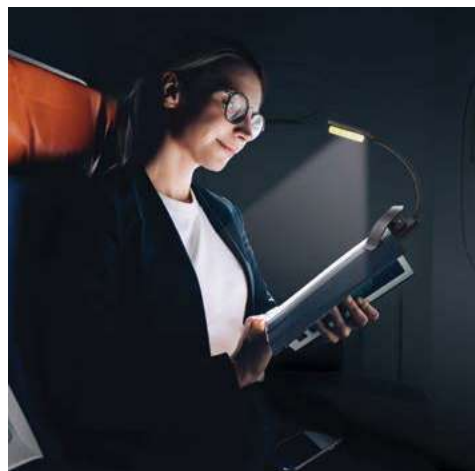

**Accessori inclusi** / Accessories included / Accessoires fournis / Accesorios incluidos / Mitgeliefertes Zubehör:



**Cavo micro USB: 100 cm**  
 USB cable: 100 cm



**Clip**  
 Clip

Codice Prodotto Item code Code Codigo Code	Lunghezza L1 Length Longueur Lungitud Länge	Larghezza L2 Width Largeur Ancho Breite	Altezza L3 Height Hauteur Altura Höhe	Imballo Packing Emballage Embalaje Verpackung	Inner Pces	Master Pces
IR236	45 mm	47 mm	347 mm	Blister FS	6	48

IR236



# LUCI DI SICUREZZA FISSE

Wall emergency lamps / Blocs de secours / Luminarias par iluminación de emergencia / Sicherheitswandleuchten

## KARY

LED

NON PERMANENTE + PERMANENTE



NEW



Protection class



Insulation class



Mechanical Resistance



ER116



Cod. Prod. Item code Code Codigo Code	Alimentazione Power source Alimentation Alimentación Stromversorgung	Tecnologia della Luce Light technology Technologie de la lumière Tecnología de iluminación Beleuchtungstechnologie	Potenza (W) Watt power Puissance Potencia Leistung	Lumen Lumen Lumen Lumen	Apertura Fascio Kind of beam Type de faisceau Tipo de haz Ausstrahlungswinkel	Batteria Battery Batterie Batería Batterie	Autonomia Runtime Autonomie Autonomía Autonomie	Tipo di luce Kelvin degrees Degrés Kelvin Temperatura de luz °K	Tipo Type Type Tipo Typ	Materiale Material Materiau Material Material
ER116	220V-240V ~ 50/60 Hz	LED SMD	2W	160 Lm	Diffuse light 120°	Li-ion 3,7V 0,7Ah (included)	3hrs	4000K	SA + SE	PC Stainles + Steel

Descrizione / Description / Description / Descripción / Beschreibung:

Lampada da incasso antiblack-out  
Antiblack-out recessed lamp  
Lampe encastrée anti coupures de courant  
Lámpara empotrada antiblack-out  
Antiblack-out Einbauleuchte

Accessori inclusi / Accessories included / Accessoires fournis / Accesorios incluidos / Mitgeliefertes Zubehör:

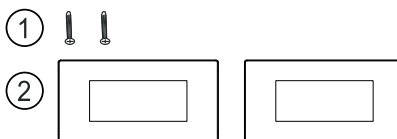

Viti + 2 cornici  
Screws + 2 covers

Codice Prodotto Item code Code Codigo Code	Lunghezza L1 Length Longueur Lungitud Länge	Larghezza L2 Width Largeur Ancho Breite	Altezza L3 Height Hauteur Altura Höhe	Imballo Packing Emballage Embalaje Verpackung	Inner Pces	Master Pces
ER116	171 mm	67 mm	25 mm	Colour box	6	24

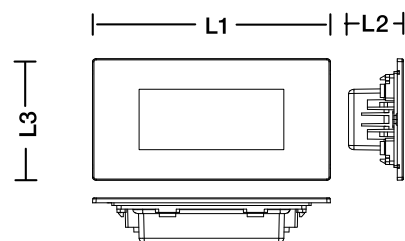

HOLLY



Not Dimmable



Protection class



Insulation class



Mechanical Resistance



Conforme EN 60598-2-22



ER122



Cod. Prod. Item code Code Codigo Code	Alimentazione Power source Alimentation Alimentación Stromversorgung	Tecnologia della Luce Light technology Technologie de la lumière Tecnología de iluminación Beleuchtungstechnologie	Potenza (W) Watt power Puissance Potencia Leistung	Lumen Lumen Lumen Lumen	Apertura Fascio Kind of beam Type de faisceau Tipo de haz Ausstrahlungswinkel	Batteria Battery Batterie Batería Batterie	Autonomia Runtime Autonomie Autonomía Autonomíe	Tipo di luce Kelvin degrees Degrés Kelvin Temperatura de luz °K	Tipo Type Type Tipo Typ	Materiale Material Materiau Material Material
ER122	220V-240V ~ 50/60 Hz	LED SMD 2835	max 3.5W	140 Lm	Diffuse light	Li-ion 2 pcs 1500mAh 7.4V (included)	2h	6500K	SA + SE	PC

Descrizione / Description / Description / Descripción / Beschreibung:

Lampada per illuminazione d'emergenza  
Self-contained luminaire for emergency lighting  
Bloc de secours non permanent  
Aparato para illumination de seguridad  
Lampe für Notbeleuchtung

Accessori inclusi / Accessories included / Accessoires fournis / Accesorios incluidos / Mitgeliefertes Zubehör:

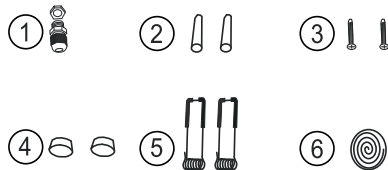

1 pressacavo, 2 tasselli, 2 viti, 2 tappi 2 clips  
1 cable gland, 2 dowels, 2 screws, 2 caps, 2 clips

INSTALLAZIONE SPORGENTE A PARETE



INSTALLAZIONE DA INCASSO E SOFFITTO



Codice Prodotto Item code Code Codigo Code	Lunghezza L1 Length Longueur Lungitud Länge	Larghezza L2 Width Largeur Ancho Breite	Altezza L3 Height Hauteur Altura Höhe	Imballo Packing Emballage Embalaje Verpackung	Inner Pces	Master Pces
ER122	292 mm	102 mm	32 mm	Colour box	6	24





# LUCI DI SICUREZZA FISSE

Wall emergency lamps / Blocs de secours / Luminarias par illuminacion de emergencia / Sicherheitswandleuchten

## STENNY



**NEW**



Not Dimmable



Protection class



Insulation class



Mechanical Resistance



Conforme EN 60598-2-22



ER127

Cod. Prod. Item code Code Codigo Code	Alimentazione Power source Alimentation Alimentación Stromversorgung	Tecnologia della Luce Light technology Technologie de la lumière Tecnología de iluminación Beleuchtungstechnologie	Potenza (W) Watt power Puissance Potencia Leistung	Lumen Lumen Lumen Lumen	Apertura Fascio Kind of beam Type de faisceau Tipo de haz Ausstrahlungswinkel	Batteria Battery Batterie Batería Batterie Li-ion	Autonomia Runtime Autonomie Autonomía Autonomie	Tipo di luce Kelvin degrees Degrés Kelvin Temperatura de luz °K	Tipo Type Type Tipo Typ	Materiale Material Material Material Material
ER127	220V-240V ~ 50/60 Hz	LED SMD 2835	4W	400 Lm	Diffuse light	7.4V 1.8Ah (included)	3h	6500K	SA + SE	PC

### Descrizione / Description / Description / Descripción / Beschreibung:

Lampada per illuminazione d'emergenza  
Self-contained luminaire for emergency lighting  
Bloc de secours non permanent  
Aparato para iluminación de seguridad  
Lampe für Notbeleuchtung

### Accessori inclusi / Accessories included / Accessoires fournis / Accesorios incluidos / Mitgeliefertes Zubehör:

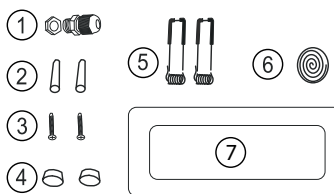

1 cornice, 1 pressacavo, 2 tasselli, 2 viti, 2 tappi 2 clips  
1 Frame, 1 cable gland, 2 dowels, 2 screws, 2 caps, 2 clips

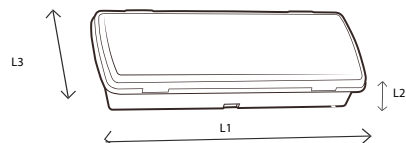

Codice Prodotto Item code Code Codigo Code	Lunghezza L1 Length Longueur Lungitud Länge	Larghezza L2 Width Largeur Ancho Breite	Altezza L3 Height Hauteur Altura Höhe	Imballo Packing Emballage Embalaje Verpackung	Inner Pces	Master Pces
ER127	270,5 mm	100 mm	54 mm	Colour box	6	24

ER127





# OVIDEA LED EVO

**320 LUMEN**

**LED TUBE TECHNOLOGY**



IR160EVO

Codice Prodotto Item code Code Codigo Code	Alimentazione Power source Alimentation Alimentación Stromversorgung	Tecnologia della Luce Light technology Technologie de la lumière Tecnología de iluminación Beleuchtungstechnologie	Potenza (W) Watt power Puissance Potencia Leistung	Lumen Lumen Lumen Lumen	Apertura Fascio Kind of beam Type de faisceau Tipo de haz Ausstrahlungswinkel	Batteria Battery Batterie Batería Batterie	Autonomia Runtime Autonomie Autonomía Autonomie	Tipo di luce Kelvin degrees Degrés Kelvin Temperatura de luz °K	Materiale Material Materiau Material Material
IR160EVO	230V ~ 50 Hz / 5V === 1000mA	SMD LED	4,5 W	320 Lm	Diffuse	3.7V 2Ah Li-ion battery (included)	2 hrs (100%) 5 hrs (50%)	6000K	PS+ABS

Descrizione / Description / Description / Descripción / Beschreibung:

Accessori inclusi / Accessories included / Accessoires fournis / Accesorios incluidos / Mitgeliefertes Zubehör:

Lanterna portatile ricaricabile antiblack-out  
Anti black-out portable rechargeable lantern  
Lampes portative rechargeable anti coupures de courant  
Lámpara LED recargable portátil de encendido automático  
Tragbare Antiblackout-Lampe, wiederaufladbar



220V ~ AC/DC Home adaptor



Codice Prodotto Item code Code Codigo Code	Lunghezza L1 Length Longueur Lungitud Länge	Larghezza L2 Width Largeur Ancho Breite	Altezza L3 Height Hauteur Altura Höhe	Imballo Packing Emballage Embalaje Verpackung	Inner Pcs	Master Pcs
IR160EVO	164 mm	104 mm	286 mm	Colour box	-	6

IR160EVO



## LUCI DI SICUREZZA PORTATILI

Portable emergency lamps / Lampes portatives rechargeables anti coupures de courant /  
Lamparas recargables portátiles anti black-out / Tragbare Notleuchten

# MINI OVIDEA LED



IR170EVO



Codice Prodotto Item code Code Codigo Code	Alimentazione Power source Alimentation Alimentación Stromversorgung	Tecnologia della Luce Light technology Technologie de la lumière Tecnología de iluminación Beleuchtungstechnologie	Potenza (W) Watt power Puissance Potencia Leistung	Lumen Lumen Lumen Lumen	Apertura Fascio Kind of beam Type de faisceau Tipo de haz Ausstrahlungswinkel	Batteria Battery Batterie Bateria Batterie	Autonomia Runtime Autonomie Autonomia Autonomie	Tipo di Luce Kelvin degrees Degrés Kelvin Temperatura de luz °K	Materiale Material Materiu Material Material
IR170EVO	220V ~ 50 Hz / 5V --- 1A	3W High power LED + LED Tube (COB)	3W	Spotlight: 100 Lm, LED tube: 170 Lm	Focus + Diffuse	Li-ion 3.7V 1.2Ah 18650 type (included)	Spotlight: 3 hrs LED tube: 2,5 hrs	6500K	ABS

**Descrizione** / Description / Description / Descripción / Beschreibung:

Lanterna portatile ricaricabile antiblack-out  
Anti black-out portable rechargeable lantern  
Lampes portative rechargeable anti coupures de courant  
Lámpara LED recargable portátil de encendido automatico  
Tragbare Antiblackout-Lampe, wiederaufladbar

**Accessori inclusi** / Accessories included / Accessoires fournis / Accesorios incluidos / Mitgeliefertes Zubehör:



220V ~ AC/DC Home adaptor



Codice Prodotto Item code Code Codigo Code	Lunghezza L1 Length Longueur Lungitud Länge	Larghezza L2 Width Largeur Ancho Breite	Altezza L3 Height Hauteur Altura Höhe	Imballo Packing Emballage Embalaje Verpackung	Inner Pces	Master Pces
IR170EVO	130 mm	75 mm	186 mm	Colour box	6	24

IR170EVO





# IRON LIGHT

Indoor lighting



**250  
LUMEN**

**LED**



IR312



Codice Prodotto Item code Code Codigo Code	Alimentazione Power source Alimentation Stromversorgung	Tecnologia della Luce Light technology Technologie de la lumière Tecnología de iluminación Beleuchtungstechnologie	Potenza (W) Watt power Puissance Potencia Leistung	Lumen Lumen Lumen Lumen	Apertura Fascio Kind of beam Type de faisceau Tipo de haz Ausstrahlungswinkel	Batteria Battery Batterie Bateria Batterie	Autonomia Runtime Autonomie Autonomía Autonomie	Tipo di luce Kelvin degrees Degrés Kelvin Temperatura de luz °K	Materiale Material Materiau Material Material
IR312	220V ~ 50/60 Hz / 5V = 150mA	21 X 5730 SMD LED	5W	250 Lm	Diffuse	3.7V 2000mAh Li-ion (included)	100% = 2,5 hrs 50% = 5 hrs	6000K	ABS + PS

**Descrizione / Description / Description / Descripción / Beschreibung:**

Lanterna portatile ricaricabile antiblack-out  
Anti black-out portable rechargeable lantern  
Lampes portative rechargeable anti coupures de courant  
Lámpara LED recargable portátil de encendido automatico  
Tragbare Antiblackout-Lampe, wiederaufladbar



**Accessori inclusi / Accessories included / Accessoires fournis / Accesorios incluidos / Mitgeliefertes Zubehör:**



220V ~ AC/DC Home adaptor

Codice Prodotto Item code Code Codigo Code	Lunghezza L1 Length Longueur Lungitud Länge	Larghezza L2 Width Largeur Ancho Breite	Altezza L3 Height Hauteur Altura Höhe	Imballo Packing Emballage Embalaje Verpackung	Inner Pces	Master Pces
IR312	126 mm	76 mm	190 mm	Colour box	6	24

IR312



## LUCI DI SICUREZZA PORTATILI

Portable emergency lamps / Lampes portatives rechargeables anti coupures de courant /  
Lámparas recargables portátiles anti black-out / Tragbare Notleuchten

### TWIX

### BIG TWIX

LED TUBE  
TECHNOLOGY

DIMMABLE

300  
LUMEN



IR162

500  
LUMEN



IR163



Indoor lighting

Codice Prod. Item code Code Codigo Code	Alimentazione Power source Alimentation Alimentación Stromversorgung	Tecnologia della Luce Light technology Technologie de la lumière Tecnología de iluminación Beleuchtungstechnologie	Potenza (W) Watt power Puissance Potencia Leistung	Lumen Lumen Lumen Lumen Lumen	Apertura Fascio Kind of beam Type de faisceau Tipo de haz Ausstrahlungswinkel	Batteria Battery Batterie Batería Batterie	Autonomia Runtime Autonomie Autonomía Autonomie	Materiale Material Matériau Material Material
IR162	220V ~ 50/60 Hz / 5V ~ 150mA	2 x 12 pcs SMD LED (5730)	8W	1 tube: 150Lm (max) 2 tubes: 300Lm (max)	Diffuse light	Lithium 3,7V 1500mAh (included)	10%: 14 hours 100%: 1 hour	ABS + PS
IR163	220V ~ 50/60 Hz / 5V ~ 150mA	2 x 24 pcs SMD LED (5730)	16W	1 tube: 250Lm (max) 2 tubes: 500Lm (max)	Diffuse light	Lithium 3,7V 2400mAh (included)	10%: 14 hours 100%: 1 hour	ABS + PS

Descrizione / Description / Description / Descripción / Beschreibung:

Accessori inclusi / Accessories included / Accessoires fournis / Accesorios incluidos / Mitgeliefertes Zubehör:

Lampada portatile ricaricabile anti black-out  
Antiblack-out portable rechargeable lantern  
Lampe portative rechargeable anti coupures de courant  
Lámpara LED recargable portátil de encendido automático  
Tragbare Antiblackout-Lampe, wiederaufladbar



220V ~ AC/DC Home adaptor



Codice Prodotto Item code Code Codigo Code	Lunghezza L1 Length Longueur Lungitud Länge	Larghezza L2 Width Largeur Ancho Breite	Altezza L3 Height Hauteur Altura Höhe	Imballo Packing Emballage Embalaje Verpackung	Inner Pces	Master Pces
IR162	75 mm	62 mm	230 mm	Colour box	6	24
IR163	75 mm	62 mm	402 mm	Colour box	6	24

IR162



IR163





## NIGHT GUARD 2

Punto luce e torcia antiblack-out  
 Antiblack-out nightlight & flashlight  
 Veilleuse & torche avec allumage automatique  
 en cas de coupure de courant  
 Punto Luz y linterna recargable anti black-out  
 Nachtlicht mit Antiblackout-Funktion



Codice Prodotto Item code Code Codigo Code	Alimentazione Power source Alimentation Alimentación Stromversorgung	Tecnologia della Luce Light technology Technologie de la lumière Tecnología de iluminación Beleuchtungstechnologie	Lumen Lumen Lumen Lumen	Tipo di fascio Kind of beam Type de faisceau Tipo de haz Ausstrahlungswinkel	Batteria Battery Batterie Bateria Batterie	Tipo di luce Kelvin degrees Degrés Kelvin Temperatura de luz °K	Autonomia Runtime Autonomie Autonomía Autonomie	Materiale Material Materiau Material Material
<b>R720</b> (vertical plug)	230V ~ 50Hz	6 LED (panel), 4 LED (torch)	40 Lm	Diffuse Light, Focus beam	Lithium-ion 3.7V 300mAh (included)	4000K	5 hrs	ABS + PC
<b>R720H</b> (horizontal plug)	230V ~ 50Hz	6 LED (panel), 4 LED (torch)	40 Lm	Diffuse Light, Focus beam	Lithium-ion 3.7V 300mAh (included)	4000K	5 hrs	ABS + PC



Codice Prodotto Item code Code Codigo Code	Lunghezza L1 Length Longueur Lungitud Länge	Larghezza L2 Width Largeur Ancho Breite	Altezza L3 Height Hauteur Altura Hohe	Imballo Packing Emballage Embalaje Verpackung	Inner Pces	Master Pces
<b>R720</b>	58,5 mm	75 mm	112 mm	Blister F4	6	48
<b>R720H</b>	58,5 mm	75 mm	112 mm	Blister F4	6	48



## LUCI NOTTURNE

Nightlights / Veilleuses / Luzes nocturnas / Nachtlampe

### MOON

Punto luce  
Nightlight  
Veilleuse  
Luz nocturna  
Nachtlampe



Insulation  
class



IL04



Codice Prodotto	Alimentazione	Tecnologia della Luce	Materiale	Lunghezza L1	Larghezza L2	Altezza L3	Imballo	Inner Pces	Master Pces	
Item code Code Codigo Code	Power source Alimentation Alimentación Stromversorgung	Light technology Technologie de la lumière Tecnología de iluminación Beleuchtungstechnologie	Material Materiau Material Material	Length Longueur Lungitud Länge	Width Largeur Ancho Breite	Height Hauteur Altura Höhe	Packing Emballage Embalaje Verpackung	Blister F1bis	12	120
<b>IL04</b>	230V ~ 50 Hz	Fluorescent bulb 0,3W	PC	43 mm	43 mm	53 mm				

IL04



### TWILIGHT

Punto luce LED con interruttore ON-OFF  
LED nightlight with ON-OFF switch  
Veilleuse LED avec interrupteur ON-OFF  
Luz nocturna con interruptor ON-OFF  
LED-Nachtlampe mit Ein-Aus-Schalter



Insulation  
class



IL09LED



Codice Prodotto	Alimentazione	Tecnologia della Luce	Materiale	Lunghezza L1	Larghezza L2	Altezza L3	Imballo	Inner Pces	Master Pces	
Item code Code Codigo Code	Power source Alimentation Alimentación Stromversorgung	Light technology Technologie de la lumière Tecnología de iluminación Beleuchtungstechnologie	Material Materiau Material Material	Length Longueur Lungitud Länge	Width Largeur Ancho Breite	Height Hauteur Altura Höhe	Packing Emballage Embalaje Verpackung	Blister F1bis	12	120
<b>IL09LED</b> (vertical plug)	230V ~ 50 Hz	2 LED	PC	66 mm	66 mm	65 mm				

IL09LED



**FROOT**

Punto luce LED con interruttore ON-OFF  
 LED nightlight with ON-OFF switch  
 Veilleuse LED avec interrupteur ON-OFF  
 Luz nocturna con interruptor ON-OFF  
 LED-Nachtlampe mit Ein-Aus-Schalter

**NEW****PERFETTO  
PER UN FRUTTO!****SPACE SAVER**Insulation  
class

IL29



Codice Prodotto Item code Code Codigo Code	Alimentazione Power source Alimentation Alimentación Stromversorgung	Tecnologia della Luce Light technology Technologie de la lumière Tecnología de iluminación Beleuchtungstechnologie	Materiale Material Materiau Material Material	Lunghezza L1 Length Longueur Lungitud Länge	Larghezza L2 Width Largeur Ancho Breite	Altezza L3 Height Hauteur Altura Höhe	Imballo Packing Emballage Embalaje Verpackung	Inner Pcs	Master Pcs
IL29	230V ~ 50/60 Hz	2 LED SMD	PC	70 mm	45 mm	23 mm	Blister F1bis	12	120

IL29

**FROOT**

Punto luce LED con interruttore ON-OFF  
 LED nightlight with ON-OFF switch  
 Veilleuse LED avec interrupteur ON-OFF  
 Luz nocturna con interruptor ON-OFF  
 LED-Nachtlampe mit Ein-Aus-Schalter

**NEW****PERFETTO  
PER UN FRUTTO!****SPACE SAVER**Insulation  
class

IL30



Codice Prodotto Item code Code Codigo Code	Alimentazione Power source Alimentation Alimentación Stromversorgung	Tecnologia della Luce Light technology Technologie de la lumière Tecnología de iluminación Beleuchtungstechnologie	Materiale Material Materiau Material Material	Lunghezza L1 Length Longueur Lungitud Länge	Larghezza L2 Width Largeur Ancho Breite	Altezza L3 Height Hauteur Altura Höhe	Imballo Packing Emballage Embalaje Verpackung	Inner Pcs	Master Pcs
IL30	230V ~ 50/60 Hz	2 LED SMD	PC	70 mm	45 mm	23 mm	Blister F1bis	12	120

IL30





## LUCI NOTTURNE

Nightlights / Veilleuses / Luzes nocturnas / Nachtlampe



### TOUCH LED

Punto luce LED con interruttore ON-OFF  
LED nightlight with ON-OFF switch  
Veilleuse LED avec interrupteur ON-OFF  
Luz nocturna con interruptor ON-OFF  
LED-Nachtlampe mit Ein-Aus-Schalter



IL28



Insulation class

Codice Prodotto Item code Code Codigo Code	Alimentazione Power source Alimentation Alimentación Stromversorgung	Tecnologia della Luce Light technology Technologie de la lumière Tecnología de iluminación Beleuchtungstechnologie	Materiale Material Materiau Material Material	Lunghezza L1 Length Longueur Lungitud Länge	Larghezza L2 Width Largeur Ancho Breite	Altezza L3 Height Hauteur Altura Höhe	Imballo Packing Emballage Embalaje Verpackung	Inner Pces	Master Pces
IL28	230V ~ 50/60 Hz	2 LED 0,5W	PC	54 mm	70 mm	54 mm	Blister F1bis	12	120

IL28



### DROP LED

Punto luce LED crepuscolare  
Crepuscolar LED nightlight  
Veilleuse crépusculaire LED  
Luz nocturna con sensor de oscuridad  
LED-Nachtlampe mit Dämmerungssensor



IL27



Insulation class

Codice Prodotto Item code Code Codigo Code	Alimentazione Power source Alimentation Alimentación Stromversorgung	Tecnologia della Luce Light technology Technologie de la lumière Tecnología de iluminación Beleuchtungstechnologie	Materiale Material Materiau Material Material	Lunghezza L1 Length Longueur Lungitud Länge	Larghezza L2 Width Largeur Ancho Breite	Altezza L3 Height Hauteur Altura Höhe	Imballo Packing Emballage Embalaje Verpackung	Inner Pces	Master Pces
IL27	230V ~ 50/60 Hz	2 LED 0,5W	PC	54 mm	70 mm	54 mm	Blister F1bis	12	120

IL27





Indoor lighting

### IL11EVO2 - CHIC 2

Luce LED con sensore di movimento  
 Motion sensor LED light  
 Lumière LED avec détecteur de mouvements  
 Luz LED con sensor de movimiento  
 LED-Leuchte mit Bewegungsmelder



IL11EVO2



COD.								+	Packing	Inner Pces	Master Pces
IL11EVO2	2 x 0,25W LED	50 Lm	>40 hrs	Diffuse Light	80 x 60 x 20 mm	3 x AAA/LR03 (not included)	ABS	Double sided tape, Screws (x1), Dowels (x1), Magnet	Blister F4	6	48

### LT011 - SMARTY

Luce LED con sensore di movimento  
 Motion sensor LED light  
 Lumière LED avec détecteur de mouvements  
 Luz LED con sensor de movimiento  
 LED-Leuchte mit Bewegungsmelder



LT011



COD.								+	Packing	Inner Pces	Master Pces
LT011	3W COB LED	200 Lm	15 hrs	Diffuse light	160 x 30.3 x 10.3 mm	3 x AAA / LR03 (not included)	ABS+AL	Velcro®, Magnet	Display: 6 pces of Blister F5	6	48

## LUCI PER ARMADI

Closet lighting / Lumières pour armoires / Luzes de armarios / Schrankbeleuchtung



### LT012 - LAGOON

Luce LED ricaricabile con sensore di movimento

Rechargeable motion sensor LED light

Lumière LED rechargeable avec détecteur de mouvements

Luz LED recargable con sensor de movimiento

Wiederaufladbares LED-Licht mit Bewegungssensor

**NEW**

Indoor lighting



LT012



COD.								+	Packing	Inner Pces	Master Pces
<b>LT012</b>	SMD LED	200 Lm	3 hrs	Diffuse Light	305 x 22 x 65 mm	Li-Po 1500mAh (included)	ABS + PC	USB cable, 3M <sup>®</sup> sticker, metal plate	Blister F8	4	24



**LT018 - SILK**

Kit striscia LED con sensore di movimento LED strip with PIR sensor  
 LED strip with PIR sensor  
 Ruban LED avec détecteur de mouvements  
 Kit de tiras led con sensor de movimiento  
 LED Strip mit PIR Bewegungssensor

Indoor lighting



LT018



COD.								+	Packing	Inner Pces	Master Pces
<b>LT018</b>	LED 2W	110 Lm	6 hrs	Diffuse Light	1000 x 8 x 3 mm	4 x AAA/LR03 (not included)	ABS+FPC	3000K warm white	Blister F6	6	48

**IL24WS - SMART LIGHT**

Mini barretta 6 LED  
 6 LED cabinet lamp  
 Mini réglette 6 LED  
 Mini regleta 6 LED  
 Schaltschrankleuchte 6 LED

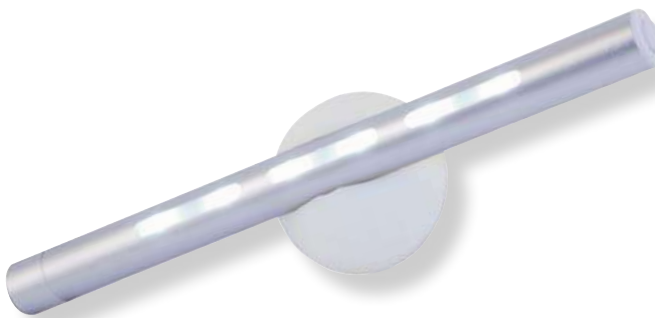

IL24WS



COD.								+	Packing	Inner Pces	Master Pces
<b>IL24WS</b>	6 LED SMD	15 Lm	15 hrs	Diffuse light	238 x 19 mm	3 x AAA/LR03 (not included)	AL+ABS	Double sided tape	Blister F6	12	48

## LUCI PER ARMADI

Closet lighting / Lumières pour armoires / Luzes de armarios / Schrankbeleuchtung



### IL84-R - RETRO'

Lampada LED con corda, appendibile

Hanging LED lamp

Ampoule LED avec cordon

Bombilla LED portátil con interruptor de cadena

LED-Hängelampe mit Kordel



IL84-R



COD.								+	Packing	Inner Pces	Master Pces
IL84-R	Standard LED 1W	50 Lm	40 hrs	Diffuse light	55 x 55 x 150 mm	3 x AAA/LR03 (not included)	ABS	Cable 105 cm (visible)	Blister F4	12	48

### IL84-B - RETRO'

Lampada LED con corda, appendibile

Hanging LED lamp

Ampoule LED avec cordon

Bombilla LED portátil con interruptor de cadena

LED-Hängelampe mit Kordel



IL84-B



COD.								+	Packing	Inner Pces	Master Pces
IL84-B	Standard LED 1W	50 Lm	40 hrs	Diffuse light	55 x 55 x 150 mm	3 x AAA/LR03 (not included)	ABS	Cable 105 cm (visible)	Blister F4	12	48



## IL05LED - PUSH LIGHT

Lampada a pressione LED  
 LED Push light  
 Lampe à pression LED  
 Lampara Led a presión  
 LED Leuchten zum Drücken



IL05LED



COD.								+	Packing	Inner Pces	Master Pces
<b>IL05LED</b>	3 Super LED	10 Lm	40 hrs	Diffuse Light	100 ø x 50 mm	2 x AA/LR6 (not included)	ABS+PS	Velcro®	Blister F4	12	72

## IL12 - MINI PUSH LIGHT LED

Push light LED  
 LED push light  
 Lampe à pression LED  
 Lampara LED a presión  
 LED Minileuchte zum Drücken



IL12



COD.								+	Packing	Inner Pces	Master Pces
<b>IL12</b>	1W COB LED	40 Lm	20 hrs	Diffuse light	ø75 x 25 mm	3 x AAA/LR03 (not included)	ABS	Double sided tape	Blister F2	12	120

## TORCE USO DOMESTICO

Flashlights for domestic use / Lampes torches pour usage domestique / Linternas para uso domestico / Taschenlampen für den Hausgebrauch



### ID72LED - LANTERNETTE EVO

Mini astuccio luminoso LED  
LED Pocket lamp  
Lampe de poche LED  
Petaca de LED  
Taschenlampe LED



ID72LED



COD.									Packing	Inner Pces	Master Pces
<b>ID72LED</b>	0,5W LED BULB	40 Lm	5 mt	40 hrs	Diffuse light	70 x 40 x 112 mm	3R12/3LR12 (not included)	Metal	Polybag	12	72

### D64 - COMPACT LED EVO

Mini astuccio luminoso 3LED  
3 LED mini pocket lamp  
Lampe de poche 3 LED  
Linterna super compacta 3 LED  
3 LED Taschenlampe



D64



COD.									Packing	Inner Pces	Master Pces
<b>D64</b>	3 LED Standard (0,3W TOTAL)	10 Lm	10 m	40 hrs	Focus light	57 x 104 x 28 mm	3 x AAA/LR03 (not included)	Metal	Blister F2	12	48



### IP05 - IMPULSE 2AA

Torcia LED 1W  
 1W LED flashlight  
 Torche LED 1W  
 Linterna LED 1W  
 Taschenlampe LED 1W



COD.										Packing	Inner Pces	Master Pces
IP05	1W High power LED	70 Lm	85 mt	10 hrs	Focus light	163 x 45 ø mm	2 x AA/LR6 (not included)	ABS+AL	Wrist band	Blister F6	6	24

### IP06 - IMPULSE 2D

Torcia LED 3W  
 3W LED flashlight  
 Torche LED 3W  
 Linterna LED 3W  
 Taschenlampe LED 3W

#### IMPUGNATURA ERGONOMICA

Ergonomic handle

#### CORPO IN ALLUMINIO

Aluminium body

#### TESTA ANTIURTO

Antishock head



#### RIFLETTORE ALTO RENDIMENTO

High performance reflector

COD.										Packing	Inner Pces	Master Pces
IP06	3W High power LED	110 Lm	120 mt	20 hrs	Focus light	200 x 65 ø mm	2 x D/LR20 (not included)	ABS+AL	Wrist band	Blister F6	6	24





## ***Home appliances & electrical materials***



## PR010-2

1000W  
2000W

Insulation class



Cod. Prod. Item code Code Codigo Code	Alimentazione Power source Alimentation Alimentación Stromversorgung	Potenza Power Puissance Potencia Leistung	Assorbimento Current Courant de fonctionnement Alimentación Betriebsstrom	Fusibile richiesto Required fuse Fusible Fusible Sicherung	Auto reset termostato Self-resetting Thermostat Déclanchement thermostat Termostato con rearme automático Auslösung des Thermostats	Vol. d'aria calda gen. Air output (m <sup>3</sup> /h) Courant d'air Vol. de salida de aire Luftstrom	Area di riscaldamento Heating area (m <sup>2</sup> ) Aire de chauffage Área de calefacción Bereich der Heizung	Temp. funzionamento Temperature range Temp. de fonctionnement Temp. de funcionamiento Betriebstemperatur	Materiale Material Matériau Material Material
PR010-2	220V-240V ~50/60Hz	1000W 2000W	8.7A	Yes	Yes	144 m <sup>3</sup> /h	12m <sup>2</sup>	0-110°	PP

## Descrizione / Description / Description / Descripción / Beschreibung:

Termoventilatore  
Fan heater  
Radiateur soufflant électrique  
Calentador  
Heizlüfter

## Accessori inclusi / Accessories included / Accessoires fournis / Accesorios incluidos / Mitgeliefertes Zubehör:

120 cm cable, H05VV-F 0.75mm<sup>2</sup> 2G  
Integrated thermostat  
Overheating protection

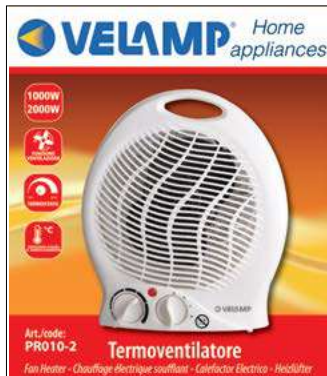

Codice Prodotto Item code Code Codigo Code	Lunghezza L1 Length Longueur Lungitud Länge	Larghezza L2 Width Largeur Ancho Breite	Altezza L3 Height Hauteur Altura Höhe	Imballo Packing Emballage Embalaje Verpackung	Master Pcs
PR010-2	225 mm	130 mm	265 mm	Colour box	8

PR010-2



# RISCALDATORI

Domestic fan heaters / Petit chauffage domestique / Calefactores domesticos / Kleine Heizlüfte

## PR012-2



1000W  
2000W

FAN  
FUNCTION

MIN MAX  
THERMOSTAT

OVER  
HEATING  
PROTECTION



Insulation class



Cod. Prod. Item code Code Codigo Code	Alimentazione Power source Alimentation Alimentación Stromversorgung	Potenza Power Puissance Potencia Leistung	Assorbimento Current Courant de fonctionnement Alimentación Betriebsstrom	Fusibile richiesto Required fuse Fusible Fusible Sicherung	Auto reset termostato Self-resetting Thermostat Déclanchement thermostat Termostato con rearme automático Auslösung des Thermostats	Vol. d'aria calda gen. Air output (m³/h) Courant d'air Vol. de salida de aire Luftstrom	Area di riscaldamento Heating area (m²) Aire de chauffage Área de calefacción Bereich der Heizung	Temp. funzionamento Temperature range Temp. de fonctionnement Temp. de funcionamiento Betriebstemperatur	Materiale Material Materiau Material Material
PR012-2	220V-240V ~50/60Hz	1000W 2000W	8.3A	Yes	Yes	180 m³/h	12m²	0-85°	PP

### Descrizione / Description / Description / Descripción / Beschreibung:

Termoventilatore oscillante  
Oscillating fan heater  
Chauffage électrique soufflant avec oscillation  
Calefactor Electrico Oscilante  
Heizlüfter

### Accessori inclusi / Accessories included / Accessoires fournis / Accesorios incluidos / Mitgeliefertes Zubehör:

120 cm cable, H05VV-F 0.75mm² 2G  
Integrated thermostat  
Overheating protection  
Safety shutdown



Codice Prodotto Item code Code Codigo Code	Lunghezza L1 Length Longueur Lungitud Länge	Larghezza L2 Width Largeur Ancho Breite	Altezza L3 Height Hauteur Altura Höhe	Imballo Packing Emballage Embalaje Verpackung	Master Pces
PR012-2	215 mm	180 mm	283 mm	Colour box	6

PR012-2



## PR014



Insulation class



Cod. Prod.	Alimentazione	Potenza	Assorbimento	Fusibile richiesto	Auto reset termostato	Vol. d'aria calda gen.	Area di riscaldamento	Temp. funzionamento	Materiale
Item code	Power source	Power	Current	Required fuse	Self-resetting Thermostat	Air output (m <sup>3</sup> /h)	Heating area (m <sup>2</sup> )	Temperature range	Material
Code	Alimentation	Puissance	Courant de fonctionnement	Fusible	Déclanchement thermostat	Courant d'air	Aire de chauffage	Temp. de fonctionnement	Materiau
Codigo	Alimentación	Potencia	Alimentación	Fusible	Termostato con rearme automático	Vol. de salida de aire	Área de calefacción	Temp. de funcionamiento	Materiau
Code	Stromversorgung	Leistung	Betriebsstrom	Sicherung	Auslösung des Thermostats	Luftstrom	Bereich der Heizung	Betriebstemperatur	Material
PR014	220V-240V ~50-60Hz	400W	1.74A	No	Yes	65 m <sup>3</sup> /h	10 m <sup>2</sup>	0-60°	ABS

Descrizione / Description / Description / Descripción / Beschreibung:

Accessori inclusi / Accessories included / Accessoires fournis / Accesorios incluidos / Mitgeliefertes Zubehör:

Stufa elettrica portatile - 400W con elementi in ceramica e display  
 Compact plug-in heater - 400W with ceramic elements and display  
 Radiateur électrique portable - 400W avec éléments céramique et display  
 Calentador de pared compacto - 400W con elementos de ceramica y pantalla  
 Kompakte Plug-In Heizung - 400W mit keramischen Elementen und Display



Codice Prodotto	Lunghezza L1	Larghezza L2	Altezza L3	Imballo	Inner Pces	Master Pces
Item code	Length	Width	Height	Packing		
Code	Longueur	Largeur	Hauteur	Emballage		
Codigo	Lungitud	Ancho	Altura	Embalaje		
Code	Länge	Breite	Höhe	Verpackung		
PR014	92 mm	82 mm	178 mm	Colour box	6	30

PR014



# RISCALDATORI

Domestic fan heaters / Petit chauffage domestique / Calefactores domesticos / Kleine Heizlüfte

## PR152

### SAFETY SHUTDOWN



Automatically shuts off if tipped



750W  
1500W

FAN  
FUNCTION

HEAT  
THERMOSTAT

°C  
OVER  
HEATING  
PROTECTION



Insulation class



Cod. Prod. Item code Code Codigo Code	Alimentazione Power source Alimentation Alimentación Stromversorgung	Potenza Power Puissance Courant de fonctionnement Alimentación Leistungsstrom	Assorbimento Current Courant de fonctionnement Alimentación Betriebsstrom	Fusibile richiesto Required fuse Fusible Fusible Sicherung	Auto reset termostato Self-resetting Thermostat Déclanchement thermostat Termostato con rearme automático Auslösung des Thermostats	Vol. d'aria calda gen. Air output (m³/h) Courant d'air Vol. de salida de aire Luftstrom	Area di riscaldamento Heating area (m²) Aire de chauffage Área de calefacción Bereich der Heizung	Temp. funzionamento Temperature range Temp. de fonctionnement Temp. de funcionamiento Betriebsstemperatur	Materiale Material Materiau Material Material
PR152	220V-240V ~50Hz	750W 1500W	6.5A	Yes	Yes	65 m³/h	12 m²	0-85°	PP

### Descrizione / Description / Description / Descripción / Beschreibung:

Termoventilatore ceramico  
Ceramic fan heater  
Radiateur soufflant céramique  
Calefactor eléctrico Cerámico  
Keramik Heizlüfter

### Accessori inclusi / Accessories included / Accessoires fournis / Accesorios incluidos / Mitgeliefertes Zubehör:

120 cm cable, H05VV-F 0.75mm² 2G  
Integrated thermostat  
Overheating protection  
Safety shutdown



Codice Prodotto Item code Code Codigo Code	Lunghezza L1 Length Longueur Lungitud Länge	Larghezza L2 Width Largeur Ancho Breite	Altezza L3 Height Hauteur Altura Höhe	Imballo Packing Emballage Embalaje Verpackung	Master Pcs
PR152	230 mm	150 mm	91 mm	Colour box	10

PR152



## PR170

## SAFETY SHUTDOWN



Automatically  
shuts off  
if tipped



400W  
800W

2  
DIFFERENT HEATS

METAL  
PROTECTION  
GRILL

CARRY  
HANDLE



Insulation class



Cod. Prod. Item code Code Codigo Code	Alimentazione Power source Alimentation Alimentación Stromversorgung	Potenza Power Puissance Potencia Leistung	Assorbimento Current Courant de fonctionnement Alimentación Betriebsstrom	Fusibile richiesto Required fuse Fusible Fusible Sicherung	Auto reset termostato Self-resetting Thermostat Déclanchement thermostat Termostato con rearme automático Auslösung des Thermostats	Area di riscaldamento Heating area (m <sup>2</sup> ) Aire de chauffage Área de calefacción Bereich der Heizung	Temp. funzionamento Temperature range Temp. de fonctionnement Temp. de funcionamiento Betriebstemperatur	Materiale Material Materiau Material Material
PR170	220V-240V ~ 50-60Hz	400W 800W	3.5A	No	No	8 m <sup>2</sup>	-	PP

## Descrizione / Description / Description / Descripción / Beschreibung:

Stufa elettrica al quarzo  
Radiant quartz heater  
Chauffage d'appoint quartz  
Estufa eléctrica de cuarzo  
Elektrischer Quartzofen

## Accessori inclusi / Accessories included / Accessoires fournis / Accesorios incluidos / Mitgeliefertes Zubehör:

120 cm cable, H05VV-F 0.75mm<sup>2</sup> 3G  
Safety shutdown



Codice Prodotto Item code Code Codigo Code	Lunghezza L1 Length Longueur Lungitud Länge	Larghezza L2 Width Largeur Ancho Breite	Altezza L3 Height Hauteur Altura Höhe	Imballo Packing Emballage Embalaje Verpackung	Master Pcs
PR170	250 mm	145 mm	360 mm	Colour box	10

PR170



# RISCALDATORI

Domestic fan heaters / Petit chauffage domestique / Calefactores domesticos / Kleine Heizlüfte

## PR162

### SAFETY SHUTDOWN



Automatically  
shuts off  
if tipped



Insulation class



400W  
800W  
1200W



Home appliances & electric materials

Cod. Prod. Item code Code Codigo Code	Alimentazione Power source Alimentation Alimentación Stromversorgung	Potenza Power Puissance Potencia Leistung	Assorbimento Current Courant de fonctionnement Alimentación Betriebsstrom	Fusibile richiesto Required fuse Fusible Fusible Sicherung	Auto reset termostato Self-resetting Thermostat Déclanchement thermostat Termostato con rearme automático Auslösung des Thermostats	Area di riscaldamento Heating area (m <sup>2</sup> ) Aire de chauffage Área de calefacción Bereich der Heizung	Temp. funzionamento Temperature range Temp. de fonctionnement Temp. de funcionamiento Betriebstemperatur	Materiale Material Matériau Material Material
PR162	220V-240V ~50/60Hz	400W 800W 1200W	5.2A	No	No	8-10 m <sup>2</sup>	-	PP

### Descrizione / Description / Description / Descripción / Beschreibung:

Pannello radiante con 3 lampade alogene  
3 halogen heating elements  
Radiateur halogène 3 puissances  
Estufa Halógena con 3 elementos calefactores  
Halogen-Heizkörper

### Accessori inclusi / Accessories included / Accessoires fournis / Accesorios incluidos / Mitgeliefertes Zubehör:

130 cm cable, H05VV-F 0.75mm<sup>2</sup> 3G  
Safety shutdown



Codice Prodotto Item code Code Codigo Code	Lunghezza L1 Length Longueur Lungitud Länge	Larghezza L2 Width Largeur Ancho Breite	Altezza L3 Height Hauteur Altura Höhe	Imballo Packing Emballage Embalaje Verpackung	Master Pces
PR162	305 mm	305 mm	720 mm	Colour box	1

PR162



## PR206T



Insulation class



Cod. Prod. Item code Code Codigo Code	Alimentazione Power source Alimentation Alimentación Stromversorgung	Potenza Power Puissance Potencia Leistung	Assorbimento Current Courant de fonctionnement Alimentación Betriebsstrom	Fusibile richiesto Required fuse Fusible Fusible Sicherung	Auto reset termostato Self-resetting Thermostat Déclanchement thermostat Termostato con rearme automático Auslösung des Thermostats	Vol. d'aria calda gen. Air output (m <sup>3</sup> /h) Courant d'air Vol. de salida de aire Luftstrom	Area di riscaldamento Heating area (m <sup>2</sup> ) Aire de chauffage Área de calefacción Bereich der Heizung	Temp. funzionamento Temperature range Temp. de fonctionnement Temp. de funcionamiento Betriebstemperatur	Materiale Material Materiau Material Material
PR206T	220V-240V ~50/60Hz	750W 1250W 2000W	8.7A	Yes	Yes	-	10-15 m <sup>2</sup>	0°-110°	Metal

## Descrizione / Description / Description / Descripción / Beschreibung:

Termoconvettore  
Convecter heater  
Convecteur mobile électrique  
Termoconvector  
Konvektor Heizkörper

## Accessori inclusi / Accessories included / Accessoires fournis / Accesorios incluidos / Mitgeliefertes Zubehör:

Cable: 1.4m H05VV-F 0.75mm<sup>2</sup> 3G  
Integrated thermostat  
Overheating protection  
Turbo function



Codice Prodotto Item code Code Codigo Code	Lunghezza L1 Length Longueur Lungitud Länge	Larghezza L2 Width Largeur Ancho Breite	Altezza L3 Height Hauteur Altura Höhe	Imballo Packing Emballage Embalaje Verpackung	Master Pcs
PR206T	530 mm	198 mm	380 mm	Colour box	1

PR206T





## VENTILATORI

Fans / Ventilateurs / Ventilador / Ventilator

### VENT-USB

#### ZEFF

Mini ventilatore da tavolo con connessione USB

Mini USB table fan

Mini ventilateur de table USB

Mini Hohe Geschwindigkeit Lüfter, mit einer USB

Mini ventilador de mesa con toma USB



#### VENT-USB



Codice Prod. Item code Code Codigo Code	Alimentazione Power source Alimentation Alimentación Stromversorgung	Velocità di funzionamento Working speeds Vitesse Velocidades Geschwindigkeiten	Potenza Power Puissance Potencia Leistung	Materiale Material Materiau Material Material	Lunghezza L1 Length Longueur Longitud Länge	Larghezza L2 Width Largeur Ancho Breite	Altezza L3 Height Hauteur Altura Höhe	Imballo Packing Emballage Embalaje Verpackung	Inner Pces	Master Pces
VENT-USB	5V ~ 1A max	1800/2200 rpm	2,5W	ABS	80 mm	148 mm	160 mm	Colour box	6	30

### IN292

Miniventilatore

Minifan

Miniventilateur

Mini ventilador

Miniventilator



#### IN292



Codice Prod. Item code Code Codigo Code	Alimentazione Power source Alimentation Alimentación Stromversorgung	Autonomia Runtime Autonomie Autonomía Autonomie	Materiale Material Materiau Material Material	Lunghezza L1 Length Longueur Longitud Länge	Larghezza L2 Width Largeur Ancho Breite	Altezza L3 Height Hauteur Altura Höhe	Imballo Packing Emballage Embalaje Verpackung	Inner Pces	Master Pces
IN292	2 x AA/LR6 (not included)	2,5 hrs	PS	70 mm	60 mm	100 mm	Display 12 pcs	12	72

### IN294

Miniventilatore con laccio da collo

Minifan with neck lace

Miniventilateur avec lacet tour de cou

Mini ventilador con collar

Miniventilator mit Halsband



#### IN294



Codice Prod. Item code Code Codigo Code	Alimentazione Power source Alimentation Alimentación Stromversorgung	Autonomia Runtime Autonomie Autonomía Autonomie	Materiale Material Materiau Material Material	Accessori forniti Accessories included Accessoires fournis Accesorios suministrados Mitgeliefertes Zubehör	Lunghezza L1 Length Longueur Longitud Länge	Larghezza L2 Width Largeur Ancho Breite	Altezza L3 Height Hauteur Altura Höhe	Imballo Packing Emballage Embalaje Verpackung	Inner Pces	Master Pces
IN294	2 x AA/LR6 (not included)	2,5 hrs	PS	Neck lace (40 cm)	60 mm	50 mm	90 mm	Display 12 pcs	12	72

**VENT-P23T4  
TERRAL 4**

Ventilatore da tavolo  
Desk fan  
Ventilateur de table  
Ventilador sobre mesa  
Tischventilator



VENT-P23T4



**VENT-P30T4  
ALIZE' 4**

Ventilatore da tavolo  
Desk fan  
Ventilateur de table  
Ventilador sobre mesa  
Tischventilator



VENT-P30T4



**VENT-P40T4  
ZONDA 4**

Ventilatore da tavolo  
Desk fan  
Ventilateur de table  
Ventilador sobre mesa  
Tischventilator



VENT-P40T4



Codice Prodotto	Alimentazione	Velocità di funzionamento	Potenza	Materiale	Lunghezza L1	Larghezza L2	Altezza L3	Imballo	Master
Item code	Power source	Working speeds	Power	Material	Length	Width	Height	Packing	Pces
Code	Alimentation	Vitesse	Puissance	Material	Longueur	Largeur	Hauteur	Emballage	
Codigo	Alimentación	Velocidades	Potencia	Material	Lungitud	Ancho	Altura	Embalaje	
Code	Stromversorgung	Geschwindigkeiten	Leistung	Material	Länge	Breite	Höhe	Verpackung	
VENT-P23T4	220V-240V ~50/60Hz	2100 / 2260 rpm	25W	ABS	2750mm	400 mm	210 mm	Colour box	6
VENT-P30T4	220V-240V ~50/60Hz	1074 / 1156 / 1260 rpm	40W	ABS	330mm	250 mm	480 mm	Colour box	1
VENT-P40T4	220V-240V ~50/60Hz	810 / 954 / 1250 rpm	40 W	ABS	415 mm	250 mm	530 mm	Colour box	1

# VENTILATORI

Fans / Ventilateurs / Ventilador / Ventilator

## VENT-P40C4 HURRICANE 4

Ventilatore a piantana  
Pedestal fan  
Ventilateur sur pied  
Ventilador sobre pié  
Standventilator

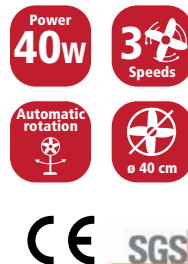

**MAX**  
**120 cm**  
MIN: 103 cm



### VENT-P40C4



Codice Prodotto Item code Code Codigo Code	Alimentazione Power source Alimentation Alimentación Stromversorgung	Velocità di funzionamento Working speeds Vitesses Velocidades Geschwindigkeiten	Potenza Power Puissance Potencia Leistung	Materiale Material Materiau Material Material	Lunghezza L1 Length Longueur Lungitud Länge	Larghezza L2 Width Largeur Ancho Breite	Altezza L3 Height Hauteur Altura Höhe	Imballo Packing Emballage Embalaje Verpackung	Master Pces
<b>VENT-P40C4</b>	220V-240V ~50/60Hz	810 / 954 / 1250 rpm	40W	ABS + Metal	600 mm	600 mm	1200 mm	Colour box	1

Home appliances & electric materials  
**VENT-P40RC**  
**ZEFIRO**

Ventilatore a piantana con telecomando  
*Pedestal fan with remote control*  
*Ventilateur sur pied avec télécommande*  
*Ventilador de pie con control remoto*  
*Standventilator mit Fernbedienung*



**MAX**  
**126 cm**  
MIN: 109 cm



VENT-P40RC



Codice Prodotto Item code Code Codigo Code	Alimentazione Power source Alimentation Alimentación Stromversorgung	Velocità di funzionamento Working speeds Vitesses Velocidades Geschwindigkeiten	Potenza Power Puissance Potencia Leistung	Materiale Material Materiau Material Material	Lunghezza L1 Length Longueur Lungitud Länge	Larghezza L2 Width Largeur Ancho Breite	Altezza L3 Height Hauteur Altura Höhe	Imballo Packing Emballage Embalaje Verpackung	Master Pces
VENT-P40RC	220V-240V ~50/60Hz	1055 / 1112 / 1322 rpm	45W	ABS	430 mm	400 mm	1260 mm	Colour box	2

# VENTILATORI

Fans / Ventilateurs / Ventilador / Ventilator

## VENT-M30T3 BORA 3

Ventilatore da tavolo  
Desk fan  
Ventilateur de table  
Ventilador sobre mesa  
Tischventilator



## VENT-M40C3 MISTRAL 3

Ventilatore a piantana  
Pedestal fan  
Ventilateur sur pied  
Ventilador sobre pié  
Standventilator



**MAX**  
130 cm  
MIN: 84 cm



### VENT-M30T3



### VENT-M40C3



Codice Prodotto Item code Code Codigo Code	Alimentazione Power source Alimentation Alimentación Stromversorgung	Velocità di funzionamento Working speeds Vitesses Velocidades Geschwindigkeiten	Potenza Power Puissance Potencia Leistung	Materiale Material Materiau Material Material	Lunghezza L1 Length Longueur Lungitud Länge	Larghezza L2 Width Largeur Ancho Breite	Altezza L3 Height Hauteur Altura Höhe	Imballo Packing Embalaje Verpackung	Master Pces
VENT-M30T3	220V-240V ~50Hz	950 / 1180 / 1280 rpm	35W	Metal	340 mm	260 mm	410 mm	Colour box	1
VENT-M40C3	220V-240V ~50Hz	950 / 1180 / 1280 rpm	50W	Metal	445 mm	410 mm	1300 mm	Colour box	1

**VENT-TURB4  
TRAMONTANA 4**

Ventilatore a turbina da pavimento  
High velocity floor fan  
Brasseur d'air  
Ventilador turbina de suelo  
Hochgeschwindigkeitsfan

Power  
**75W**

**3**  
Speeds

Adjustable  
tilt

ø 45 cm

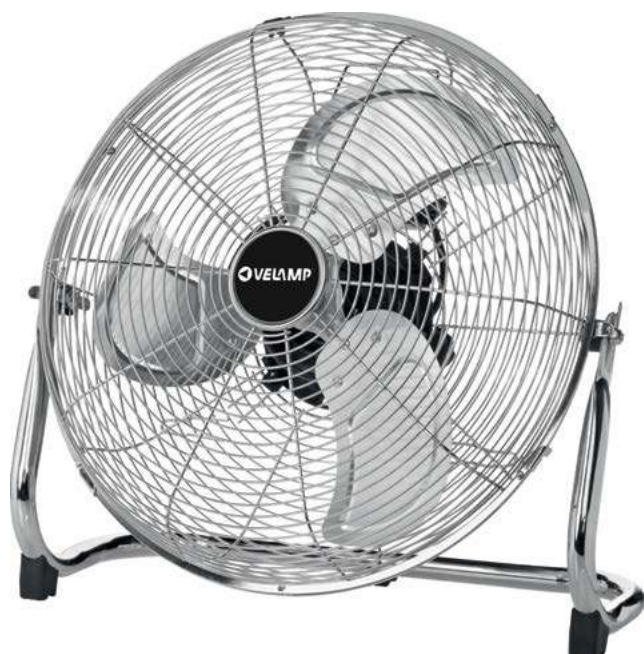

VENT-TURB4



Codice Prodotto	Alimentazione	Velocità di funzionamento	Potenza	Materiale	Lunghezza L1	Larghezza L2	Altezza L3	Imballo	Master Pces
Item code Code Codigo Code	Power source Alimentation Alimentación Stromversorgung	Working speeds Vitesses Velocidades Geschwindigkeiten	Power Puissance Potencia Leistung	Material Materiau Material Material	Length Longueur Lungitud Länge	Width Largeur Ancho Breite	Height Hauteur Altura Höhe	Packing Emballage Embalaje Verpackung	
<b>VENT-TURB4</b>	220V~240V ~50/60Hz	1050 / 1219 / 1327 rpm	75W	Metal	500 mm	200 mm	485 mm	Colour box	1

## VENTILATORI

Fans / Ventilateurs / Ventilador / Ventilator

### VENT-BOX-4 KATIA 4

Ventilatore da tavolo quadrato  
Box fan  
Ventilateur box  
Ventilador de sobremesa cuadrado  
Tischventilator



Power  
**40w** **3**  
Speeds

Rotating  
grill  
ø 30 cm

Timer  
**1h**

CE SGS

Home appliances & electric materials

#### VENT-BOX4



Codice Prodotto	Alimentazione	Velocità di funzionamento	Potenza	Materiale	Lunghezza L1	Larghezza L2	Altezza L3	Imballo	Master
Item code Code Codigo Code	Power source Alimentation Alimentación Stromversorgung	Working speeds Vitesses Velocidades Geschwindigkeiten	Power Puissance Potencia Leistung	Material Materiau Material Material	Length Longueur Lungitud Länge	Width Largeur Ancho Breite	Height Hauteur Altura Höhe	Packing Emballage Embalaje Verpackung	Pcs
<b>VENT-BOX4</b>	220V-240V ~50/60Hz	1040/1130/1270 rpm	40W	ABS	380 mm	140 mm	450 mm	Colour box	1

**VENT-COLT4  
PAMPERO 4**

Ventilatore a colonna con timer  
Tower fan with timer  
Ventilateur colonne avec programmateur  
Ventilador de columna con temporizador  
Säulenventilator

Power  
**45W**

**3**  
Speeds

Automatic  
rotation

Timer  
**2h**

CE SGS



**H**  
**73cm**



VENT-COLT4



Codice Prodotto	Alimentazione	Velocità di funzionamento	Potenza	Materiale	Lunghezza L1	Larghezza L2	Altezza L3	Imballo	Master
Item code	Power source	Working speeds	Power	Material	Length	Width	Height	Packing	Pces
Code	Alimentación	Vitesse	Puissance	Material	Longueur	Largeur	Hauteur	Emballage	
Codigo	Alimentación	Velocidades	Potencia	Material	Lungitud	Ancho	Altura	Embalaje	
Code	Stromversorgung	Geschwindigkeiten	Leistung	Material	Länge	Breite	Höhe	Verpackung	
<b>VENT-COLT4</b>	220V-240V ~50/60Hz	950 / 1150 / 1290 rpm	45W	ABS	220	220	730	Colour box	1



# VENTILATORI

Fans / Ventilateurs / Ventilador / Ventilator

## VENT-CEL32 IRMA 3



Luce accendibile separatamente:  
1 x E27 (max.60W - lampadina non inclusa)  
Independent light control:  
1 x E27 (max 60W – bulb not included)  
Lumière avec allumage indépendant:  
1 x E27 (max 60W – ampoule non fournie)  
Luzes encendibles separadamente:  
1 x e27 (max.60W - lámpara no incluida)  
Unabhängige Lichtkontrolle:  
1 x E27 (max 60W – Leuchtmittel nicht im Lieferumfang)



INCLUDED



VENT-CEL32



Codice Prodotto	Alimentazione	Velocità di funzionamento	Potenza	Materiale	Lunghezza L1	Larghezza L2	Altezza L3	Imballo	Master
Item code	Power source	Working speeds	Power	Material	Length	Width	Height	Packing	Pces
Code	Alimentation	Vitesse	Puissance	Material	Longueur	Largeur	Hauteur	Emballage	
Codigo	Alimentación	Velocidades	Potencia	Material	Lungitud	Ancho	Altura	Embalaje	
Code	Stromversorgung	Geschwindigkeiten	Leistung	Material	Länge	Breite	Höhe	Verpackung	
<b>VENT-CEL32</b>	220V-240V ~50Hz	130 / 210 / 285 rpm	60W	Metal + ABS	1200 mm	1200 mm	630 mm	Colour box	1

## VENT-CEL33 HAVANA 3



Luce accendibile separatamente:  
1 x E27 (max.60W - lampadina non inclusa)  
Independent light control:  
1 x E27 (max 60W – bulb not included)  
Lumière avec allumage indépendant:  
1 x E27 (max 60W – ampoule non fournie)  
Luzes encendibles separadamente:  
1 x e27 (max.60W - lámpara no incluida)  
Unabhängige Lichtkontrolle:  
1 x E27 (max 60W – Leuchtmittel nicht im Lieferumfang)

VENT-CEL33



Codice Prodotto	Alimentazione	Velocità di funzionamento	Potenza	Materiale	Lunghezza L1	Larghezza L2	Altezza L3	Imballo	Master
Item code	Power source	Working speeds	Power	Material	Length	Width	Height	Packing	Pces
Code	Alimentation	Vitesse	Puissance	Material	Longueur	Largeur	Hauteur	Emballage	
Codigo	Alimentación	Velocidades	Potencia	Material	Lungitud	Ancho	Altura	Embalaje	
Code	Stromversorgung	Geschwindigkeiten	Leistung	Material	Länge	Breite	Höhe	Verpackung	
<b>VENT-CEL33</b>	220V-240V ~50Hz	115 / 185 / 235 rpm	50W	Metal + MDF	1070 mm	1070 mm	630 mm	Colour box	1

## MINICOOL ADELY

Mini raffrescatore evaporativo  
Mini air cooler  
Mini ventilateur et rafraichisseur d'air  
Mini enfriador evaporativo  
Mini Verdunstungskühler



Codice Prodotto Item code Code Codigo Code	Alimentazione Power source Alimentation Alimentación Stromversorgung	Velocità di funzionamento Working speeds Vitesses Velocidades Geschwindigkeiten	Potenza Power Puissance Potencia Leistung	Materiale Material Materiau Material Material	Batteria Battery Batterie	Funzioni Functions Fonctions Función Funktionen
MINICOOL	5V ~ 1A max (not included)	3 speeds: 2200 / 3000 / 3350 rpm	Fan function: 5W Ionizer function: 1W	ABS	3V 2000mAh	<ul style="list-style-type: none"> <li>Fan function: 3 speeds</li> <li>Ionizer function:                             <ul style="list-style-type: none"> <li>Ions concentration : 1x106 PCS/cm<sup>3</sup></li> <li>Ozone concentration : &lt;0.03 PPM</li> </ul> </li> <li>Night light</li> </ul>



**Accessori inclusi / Accessories included / Accessoires fournis / Accesorios incluidos / Mitgeliefertes Zubehör:**  
Cavo USB incluso / 100 cm USB cable included

**Accessori compatibili / Compatible accessories / Accessoires compatibles / Accesorios compatibles / Kompatibles Zubehör:**

MINICOOL-PAD	12 Filtri in cotone per MINICOOL 12 Cotton filters for MINICOOL 12 Filtras en coton pour MINICOOL 12 Filtras en algodón para MINICOOL 12 Filter aus Baumwolle für MINICOOL	Polybag	 8 003910 107120 >
--------------	--	---------	--

MINICOOL



Codice Prodotto Item code Code Codigo Code	Lunghezza L1 Length Longueur Lungitud Länge	Larghezza L2 Width Largeur Ancho Breite	Altezza L3 Height Hauteur Altura Höhe	Imballo Packing Emballage Embalaje Verpackung	Inner Pcs	Master Pcs
MINICOOL	120 mm	127 mm	132 mm	Colour box	4	32

# VENTILATORI

Fans / Ventilateurs / Ventilador / Ventilator

## COOLER34 EMPEROR

Raffrescatore evaporativo

Aircooler

Ventilateur et rafraichisseur d'air

Enfriador evaporativo

Verdunstungskühler



Oscillating function

2 ice boxes included



COOLER34



Codice Prodotto	Alimentazione	Flusso d'aria	Potenza	Materiale	Lunghezza L1	Larghezza L2	Altezza L3	Imballo	Master
Item code Code Codigo Code	Power source Alimentation Alimentación Stromversorgung	Air flow Flux d'air Flujo de aire Lufstrom	Power Puissance Potencia Leistung	Material Materiau Material Material	Length Longueur Longitud Länge	Width Largeur Ancho Breite	Height Hauteur Altura Höhe	Packing Emballage Embalaje Verpackung	Pcs
<b>COOLER34</b>	220V-240V ~50/60Hz	300m³/h	75W	ABS	250 mm	270 mm	570 mm	Colour box	1



### REPEL01- MOSQUITO STOP

Dispositivo antizanzare  
 Mosquito repellent plug-in  
 Prise anti-moustiques  
 Dispositivo repelente de mosquitos  
 Mückenschutzgerät



REPEL01



Codice Prod. Item code Code Codigo Code	Alimentazione Power source Alimentation Alimentación Stromversorgung	Area protetta Designed to protect about Conçue pour environ Diseñado para aprox. Konzipiert für ca.	Consumo energetico Power consumption Consommation électrique Consumo de energía Energieverbrauch	Materiale Material Materiau Material Material	Lunghezza L1 Length Longueur Longitud Länge	Larghezza L2 Width Largeur Ancho Breite	Altezza L3 Height Hauteur Altura Höhe	Imballo Packing Emballage Embalaje Verpackung	Inner Pces	Master Pces
REPEL01	220-240V ~ 50/60Hz	15m <sup>2</sup>	0,5W	ABS	70	30	55	Blister	6	48

### REPEL02 - SMASH

Racchetta elettrica anti zanzare  
 Electric mosquito swatter  
 Raquette électrique anti-moustiques  
 Elektrische Mückenklatsche  
 Raqueta eléctrica antimosquitos



REPEL02



Codice Prod. Item code Code Codigo Code	Alimentazione Power source Alimentation Alimentación Stromversorgung	Tensione di funzionamento Working voltage Tension de fonctionnement Tensión de funcionamiento Betriebsspannung	Rete Net Grille Rejilla Gitter	Materiale Material Materiau Material Material	Lunghezza L1 Length Longueur Longitud Länge	Larghezza L2 Width Largeur Ancho Breite	Altezza L3 Height Hauteur Altura Höhe	Imballo Packing Emballage Embalaje Verpackung	Inner Pces	Master Pces
REPEL02	2 x AA/LR6 (not included)	1900V / 2100V	3 Layers	ABS / Metal	480	180	30	Polybag	12	36

# ANTIZANZARE

Mosquito killers / Moustiquaires électriques / Red mosquito eléctricos / Elektrisches Moskitonetz



## MK040 - MINIZAP



UV LED  
**1W**

**12m<sup>2</sup>**

NON TOXIC

NON ODOR

NO NOISE

NO RADIATION



Cod. Prod. Item code Code Codigo Code	Alimentazione Power source Alimentation Alimentación Stromversorgung	Tensione di funzionamento Working voltage Tension de fonctionnement Tensión de funcionamiento Betriebsspannung	Tecnologia Technologie Technologie Tecnología Technologie	Area protetta Designed to protect about Conçue pour environ Diseñado para aprox. Konzipiert für ca.	Consumo energetico Power consumption Consumation électrique Consumo de energía Energieverbrauch	Accessori forniti Accessories included Accessoires fournis Accesorios suministrados Mitgeliefertes Zubehör	Materiale Material Materiau Material Material
MK040	220-240V ~ 50/60Hz	800V / 1000V	4 UV LED (0,06W)	12m <sup>2</sup>	1W	1 Spazzola	ABS / Metal
MK040H	220-240V ~ 50/60Hz	800V / 1000V	4 UV LED (0,06W)	12m <sup>2</sup>	1W	1 Brush	ABS / Metal

**Descrizione** / Description / Description / Descripción / Beschreibung:

Zanzariera elettrica 1W  
Mosquito killer 1W  
Moustiquaire électrique 1W  
Red mosquito eléctrico 1W  
Elektrisches Moskitonetz 1W

**Accessori inclusi** / Accessories included / Accessoires fournis / Accesorios incluidos / Mitgeliefertes Zubehör:

1 spazzola  
1 Brush



Codice Prodotto Item code Code Codigo Code	Lunghezza L1 Length Longueur Lungitud Länge	Larghezza L2 Width Largeur Ancho Breite	Altezza L3 Height Hauteur Altura Höhe	Imballo Packing Emballage Embalaje Verpackung	Inner Pces	Master Pces
MK040	101	61	120	Colour box	6	60
MK040H	101	61	120	Colour box	6	60





ANTIZANZARE

Mosquito killers / Moustiquaires électriques / Red mosquito eléctricos / Elektrisches Moskitonetz

# MK180 GHOST

Home appliances & electric materials

**HOW DOES IT WORK?**

- THE UV LIGHT ATTRACTS INSECTS
- THEY ARE KILLED FROM THE ELECTRIC DISCHARGE
- THE FAN ASPIRATES THEM AND MAKES THEM FALL INTO THE TRAY



UV FLUORESCENT LAMP  
**14W**

**30m<sup>2</sup>**

NON TOXIC

NON ODOR

NO NOISE

NO RADIATION



Codice Prod. Item code Code Codigo Code	Alimentazione Power source Alimentation Alimentación Stromversorgung	Tensione di funzionamento Working voltage Tension de fonctionnement Tensión de funcionamiento Betriebsspannung	Tecnologia Technology Technologie Tecnología Technologie	Area protetta Designed to protect about Conçue pour environ Diseñado para aprox. Konzipiert für ca.	Consumo energetico Power consumption Consommation électrique Consumo de energía Energieverbrauch	Materiale Material Materiau Material Material
<b>MK180</b>	220-240V ~ 50/60Hz	800V / 1000V	1 Fluorescent UV lamp type: BL-2U-F9W	30m <sup>2</sup>	14W	ABS / Metal

**Descrizione** / Description / Description / Descripción / Beschreibung:

Zanzariera elettrica 14W  
Mosquito killer 14W  
Moustiquaire électrique 14W  
Red mosquito eléctrico 14W  
Elektrisches Moskitonetz 14W

**Accessori inclusi** / Accessories included / Accessoires fournis / Accesorios incluidos / Mitgeliefertes Zubehör:

1 spazzola  
1 Brush



Codice Prodotto Item code Code Codigo Code	Lunghezza L1 Length Longueur Lungitud Länge	Larghezza L2 Width Largeur Ancho Breite	Altezza L3 Height Hauteur Altura Höhe	Imballo Packing Emballage Embalaje Verpackung	Inner Pces	Master Pces
<b>MK180</b>	190	1110	223	Colour box	-	6

MK180



# ANTIZANZARE

Mosquito killers / Moustiquaires électriques / Red mosquito eléctricos / Elektrisches Moskitonetz



## MK170 BLACKZAP



UV  
FLUORESCENT  
LAMP  
**7W**

**25m<sup>2</sup>**

NON  
TOXIC

NON  
ODOR

NO  
NOISE

NO  
RADIATION



Codice Prod. Item code Code Codigo Code	Alimentazione Power source Alimentation Alimentación Stromversorgung	Tensione di funzionamento Working voltage Tension de fonctionnement Tensión de funcionamiento Betriebsspannung	Tecnologia Technology Technologie Tecnología Technologie	Area protetta Designed to protect about Conçue pour environ Diseñado para aprox. Konzipiert für ca.	Consumo energetico Power consumption Consommation électrique Consumo de energía Energieverbrauch	Materiale Material Materiau Material Material
<b>MK170</b>	220-240V ~ 50/60Hz	800V / 1000V	1 Fluorescent UV lamp type: PL1X7W	25m <sup>2</sup>	7W	ABS / Metal

### Descrizione / Description / Description / Descripción / Beschreibung:

Zanzariera elettrica 7W  
Mosquito killer 7W  
Moustiquaire électrique 7W  
Red mosquito eléctrico 7W  
Elektrisches Moskitonetz 7W

### Accessori inclusi / Accessories included / Accessoires fournis / Accesorios incluidos / Mitgeliefertes Zubehör:

1 spazzola  
1 Brush



Codice Prodotto Item code Code Codigo Code	Lunghezza L1 Length Longueur Lungitud Länge	Larghezza L2 Width Largeur Ancho Breite	Altezza L3 Height Hauteur Altura Höhe	Imballo Packing Emballage Embalaje Verpackung	Inner Pces	Master Pces
<b>MK170</b>	131	131	258	Colour box	6	24

MK170





# MK174E RATTAN

Home appliances & electric materials



UV  
FLUORESCENT  
LAMP  
**19W**

**80m<sup>2</sup>**

NON  
TOXIC

NON  
ODOR

NO  
NOISE

NO  
RADIATION



Codice Prod.	Alimentazione	Tensione di funzionamento	Tecnologia	Area protetta	Consumo energetico	Materiale
Item code Code Codigo Code	Power source Alimentation Alimentación Stromversorgung	Working voltage Tension de fonctionnement Tensión de funcionamiento Betriebsspannung	Technology Technologie Tecnología Betriebsspannung	Designed to protect about Conçue pour environ Diseñado para aprox. Konzipiert für ca.	Power consumption Consommation électrique Consumo de energía Energieverbrauch	Material Materiau Material Material
<b>MK174E</b>	220-240V ~ 50/60Hz	2700V / 3000V	1 Fluorescent UV lamp type: PL18W	80 m <sup>2</sup>	19W	ABS / Metal

**Descrizione** / Description / Description / Descripción / Beschreibung:

Zanzariera elettrica 19W  
Mosquito killer 19W  
Moustiquaire électrique 19W  
Red mosquito eléctrico 19W  
Elektrisches Moskitonetz 19W

**Accessori inclusi** / Accessories included / Accessoires fournis / Accesorios incluidos / Mitgeliefertes Zubehör:

1 spazzola e un gancio per sospensione  
1 Brush, 1 Hook for hanging



Codice Prodotto	Lunghezza L1	Larghezza L2	Altezza L3	Imballo	Inner Pces	Master Pces
Item code Code Codigo Code	Length Longueur Lungitud Länge	Width Largeur Ancho Breite	Height Hauteur Altura Höhe	Packing Emballage Embalaje Verpackung		
<b>MK174E</b>	165	165	310	Colour box	-	6

MK174E





# ANTIZANZARE

Mosquito killers / Moustiquaires électriques / Red mosquito eléctricos / Elektrisches Moskitonetz



## MK312 THUNDER MINI



UV  
FLUORESCENT  
TUBES  
**2x6W**

**30m<sup>2</sup>**

NON  
TOXIC

NON  
ODOR

NO  
NOISE

NO  
RADIATION



Home appliances & electric materials

Codice Prod. Item code Code Codigo Code	Alimentazione Power source Alimentation Alimentación Stromversorgung	Tensione di funzionamento Working voltage Tension de fonctionnement Tensión de funcionamiento Betriebsspannung	Tecnologia Technology Technologie Tecnología Technologie	Area protetta Designed to protect about Conçue pour environ Diseñado para aprox. Konzipiert für ca.	Consumo energetico Power consumption Consommation électrique Consumo de energía Energieverbrauch	Materiale Material Materiau Material Material
<b>MK312</b>	220-240V ~ 50/60Hz	2200V / 2500V	2 x 6W UV neon fluorescent tubes	30m <sup>2</sup>	12W	ABS, Metal

**Descrizione** / Description / Description / Descripción / Beschreibung:

Zanzariera elettrica 2X6W  
Mosquito killer 2X6W  
Moustiquaire électrique 2X6W  
Red mosquito eléctrico 2X6W  
Elektrisches Moskitonetz 2X6W

**Accessori inclusi** / Accessories included / Accessoires fournis / Accesorios incluidos / Mitgeliefertes Zubehör:

Catena per sospensione  
Hanging chain



Codice Prodotto Item code Code Codigo Code	Lunghezza L1 Length Longueur Lungitud Länge	Larghezza L2 Width Largeur Ancho Breite	Altezza L3 Height Hauteur Altura Höhe	Imballo Packing Emballage Embalaje Verpackung	Inner Pces	Master Pces
<b>MK312</b>	260	73	265	Colour box	-	6

MK312





# MK320 THUNDER MIDI



UV  
FLUORESCENT  
TUBES  
**2x10W**

**80m<sup>2</sup>**

**NON  
TOXIC**

**NON  
ODOR**

**NO  
NOISE**

**NO  
RADIATION**



Codice Prod. Item code Code Codigo Code	Alimentazione Power source Alimentation Alimentación Stromversorgung	Tensione di funziona- mento Working voltage Tension de fonctionnement Tensión de funcionamiento Betriebsspannung	Tecnologia Technology Technologie Tecnología Leuchtentechnologie	Area protetta Designed to protect about Conçue pour environ Diseñado para aprox. Konzipiert für ca.	Consumo energetico Power consumption Consommation électrique Consumo de energia Energieverbrauch	Accessori forniti Accessories included Accessoires fournis Accesorios suministrados Mitgeliefertes Zubehör	Materiale Material Materiau Material Material
<b>MK320</b>	220-240V ~ 50/60Hz	2200V / 2500V	2 x 10W UV neon fluorescent tubes	80m <sup>2</sup>	20W	Hanging Chain	ABS, Metal

**Descrizione** / Description / Description / Descripción / Beschreibung:

Zanzariera elettrica 2X10W  
Mosquito killer 2X10W  
Moustiquaire électrique 2X10W  
Red mosquito eléctrico 2X10W  
Elektrisches Moskitonetz 2X10W

**Accessori inclusi** / Accessories included / Accessoires fournis / Accesorios incluidos / Mitgeliefertes Zubehör:

Catena per sospensione  
Hanging chain



Codice Prodotto Item code Code Codigo Code	Lunghezza L1 Length Longueur Lungitud Länge	Larghezza L2 Width Largeur Ancho Breite	Altezza L3 Height Hauteur Altura Höhe	Imballo Packing Emballage Embalaje Verpackung	Inner Pces	Master Pces
<b>MK320</b>	379	72	264	Colour box	-	6

**MK320**



# ANTIZANZARE

Mosquito killers / Moustiquaires électriques / Red mosquito eléctricos / Elektrisches Moskitonetz



## MK340 THUNDER MAXI

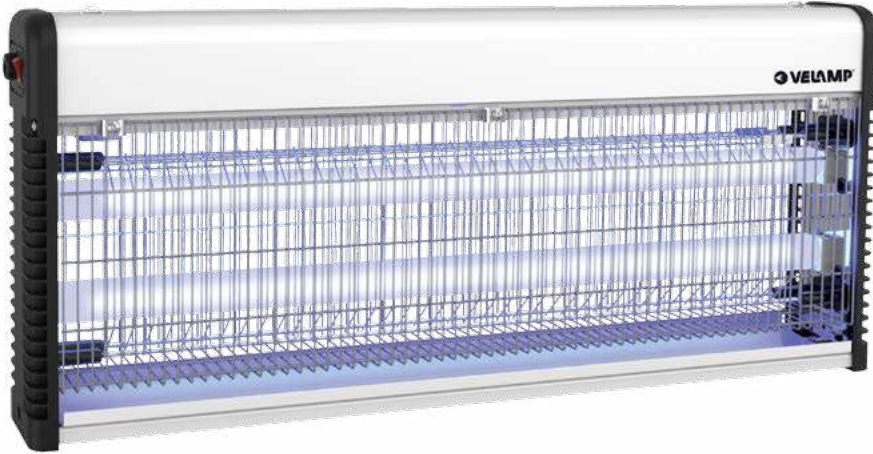

UV  
FLUORESCENT  
TUBES  
2x18W

150m<sup>2</sup>

NON  
TOXIC

NON  
ODOR

NO  
NOISE

NO  
RADIATION



Home appliances & electric materials

Codice Prod. Item code Code Codigo Code	Alimentazione Power source Alimentation Alimentación Stromversorgung	Tensione di funziona- mento Working voltage Tension de fonctionnement Tensión de funcionamiento Betriebsspannung	Tecnologia Technology Technologie Tecnología Leuchtentechnologie	Area protetta Designed to protect about Conçue pour environ Diseñado para aprox. Konzipiert für ca.	Consumo energetico Power consumption Consommation électrique Consumo de energia Energieverbrauch	Accessori forniti Accessories included Accessoires fournis Accesorios suministrados Mitgeliefertes Zubehör	Materiale Material Materiau Material Material
<b>MK340</b>	220-240V ~ 50/60Hz	2200V / 2500V	2 x 18W UV neon fluorescent tubes	150m <sup>2</sup>	36W	Hanging chain	ABS, Metal

**Descrizione** / Description / Description / Descripción / Beschreibung:

Zanzariera elettrica 2X18W  
Mosquito killer 2X18W  
Moustiquaire électrique 2X18W  
Red mosquito eléctrico 2X18W  
Elektrisches Moskitonetz 2X18W

**Accessori inclusi** / Accessories included / Accessoires fournis / Accesorios incluidos / Mitgeliefertes Zubehör:

Catena per sospensione  
Hanging chain



Codice Prodotto Item code Code Codigo Code	Lunghezza L1 Length Longueur Lungitud Länge	Larghezza L2 Width Largeur Ancho Breite	Altezza L3 Height Hauteur Altura Höhe	Imballo Packing Emballage Embalaje Verpackung	Inner Pces	Master Pces
<b>MK340</b>	637	72	264	Colour box	-	4

MK340



**DOM008 - KINY**

Campanello senza fili ad energia cinetica  
 AC wireless doorbell with kinetic energy  
 Carillon sans fil à énergie cinétique  
 Timbre inalámbrico de energía cinética  
 Drahtlose Türklingel mit kinetischer Energie



DOM008



(Button)

**NEW****180mt**

Codice Item code Code Codigo Code		Raggio d'azione Detection range Rayon d'action Rayo de accion Reichweite	Larghezza Width Largeur Ancho Breite	Lunghezza Length Longueur Lungitud Länge	Altezza Height Hauteur Altura Höhe	Materiale Material Materiau Material Material	Imballo Packing Emballage Embalaje Verpackung	Inner Pces	Master Pces
DOM008	10 melodies	180 m	Receiver: 57mm Transmitter: 40 mm	108 mm 90 mm	68 mm 23 mm	ABS	Hangable box	6	48

**DOM001 - DOORBELL**

Campanello senza fili a pile  
 Battery operated wireless doorbell  
 Carillon sans fil à piles  
 Timbre inalámbrico con pilas  
 Drahtlose Klingel, batteriebetrieben



DOM001



(Button)



Codice Item code Code Codigo Code		Raggio d'azione Detection range Rayon d'action Rayo de accion Reichweite	Larghezza Width Largeur Ancho Breite	Lunghezza Length Longueur Lungitud Länge	Altezza Height Hauteur Altura Höhe	Batterie Battery Batterie Batterie Batterie	Materiale Material Materiau Material Material	Imballo Packing Emballage Embalaje Verpackung	Inner Pces	Master Pces
DOM001	25 melodies	100 m	95 mm	30 mm	66 mm	Bell: 2 x AA (not included) Button: 1 x CR2032 (included)	ABS	Blister F4	6	48

## DOMOTICA

Domotics / Domotique / Domotica / Domotik

### THERM02 - COSY METEO

Stazione meteo da interno  
 Indoor weather station  
 Station météo d'intérieur  
 Estacion meteorológica inalámbrica para intern  
 Wetterstation für Inneno



THERM02



AG10



ALARM  
SNOOZE



12:02  
TIME



HOME  
TEMP



CALENDAR



HUMIDITY



LUNAR  
CALENDAR



TREND



Codice Item code Code Codigo Code	Larghezza Width Largeur Ancho Breite	Lunghezza Length Longueur Lungitud Länge	Altezza Height Hauteur Altura Höhe	Batterie Battery Baterie Baterie Batterie	Materiale Material Materiau Material Material	Imballo Packing Emballage Embalaje Verpackung	Inner Pces	Master Pces
THERM02	57 mm	50 mm	113 mm	1 X AG10 (included)	ABS	Blister F4	12	72

### CCTV01

Cartello di segnalazione area videosorveglianza



CCTV01



Codice Item code Code Codigo Code	Larghezza Width Largeur Ancho Breite	Altezza Height Hauteur Altura Höhe	Materiale Material Materiau Material Material	Imballo Packing Emballage Embalaje Verpackung	Inner Pces	Master Pces
CCTV01	200 mm	300 mm	Acrylic	Polybag	10	80

**MS002 - MOTION SENSOR 2**

Rilevatore di movimento ad infrarossi

*Infrared motion detector**Détecteur de mouvements infrarouge**Detector de movimiento infrarrojo**Infrarot-Bewegungsmelder*

MS002



Codice Item code Code Codigo Code	Alimentazione Power source Alimentation Alimentación Stromversorgung	Altezza d'install. Installation height Hauteur d'installation Altura para instalación Installationshöhe	Carico max. Max. load Charge max. Carga máx. Last max.	Sensibilità lum. Min. ambient light Sensibilité lumineuse min. Sensibilidad luminosa min. Lichtempfindlichkeit min.	Raggio d'azione Detection range Rayon d'action Rayo de acción Reichweite	Durata Working time Temps de fonct. Tiempo de func. Betriebsdauer	Apertura focale Angle Angle Abertura del foco Blendenöffnung	Materiale Material Materiau Material Material	Imballo Packing Emballage Embalaje Verpackung	Inner Pces	Master Pces
MS002	220V ~ 50 Hz	3,5 m (+/- 0,5 m)	1000W	3 Lux	max 12 m	8 sec - 7 min	140°-180°	ABS	Blister F4	6	36

**MS005 - MOTION SENSOR 2 BLACK**

Rilevatore di movimento ad infrarossi

*Infrared motion detector**Détecteur de mouvements infrarouge**Detector de movimiento infrarrojo**Infrarot-Bewegungsmelder*

MS005



Codice Item code Code Codigo Code	Alimentazione Power source Alimentation Alimentación Stromversorgung	Altezza d'install. Installation height Hauteur d'installation Altura para instalación Installationshöhe	Carico max. Max. load Charge max. Carga máx. Last max.	Sensibilità lum. Min. ambient light Sensibilité lumineuse min. Sensibilidad luminosa min. Lichtempfindlichkeit min.	Raggio d'azione Detection range Rayon d'action Rayo de acción Reichweite	Durata Working time Temps de fonct. Tiempo de func. Betriebsdauer	Apertura focale Angle Angle Abertura del foco Blendenöffnung	Materiale Material Materiau Material Material	Imballo Packing Emballage Embalaje Verpackung	Inner Pces	Master Pces
MS005	220V ~ 50 Hz	3,5 m (+/- 0,5 m)	1000W	3 Lux	max 12 m	8 sec - 7 min	140°-180°	ABS	Blister F4	6	36

# DOMOTICA

Domotics / Domoitique / Domotica / Domotik

## MS007 - CELENS

Rilevatore di movimento ad infrarossi da incasso  
 Recessed mounting infrared motion detector  
 Détecteur de mouvements infrarouge encastré  
 Detector de movimiento infrarrojo para techo  
 Einbaumontage Infrarot-Bewegungsmelder



MS007

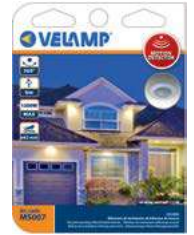

Codice Item code Code Codigo Code	Alimentazione Power source Alimentation Alimentación Stromversorgung	Altezza d'install. Installation height Hauteur d'installation Altura para instalación Installationshöhe	Carico max. Max. load Charge max. Carga máx. Last max.	Sensibilità lum. Min. ambient light Sensibilité lumineuse min. Sensibilidad luminosa min. Lichtempfindlichkeit min.	Durata Working time Temps de fonct. Tiempo de func. Betriebsdauer	Raggio d'azione Detection range Rayon d'action Rayo de acción Reichweite	Apertura focale Angle Angle Abertura del foco Blendenöffnung	Materiale Material Materiau Material Material	Imballo Packing Emballage Embalaje Verpackung	Inner Pcs	Master Pcs
MS007	220V ~ 50 Hz	2,2m - 4 m	1200W	3 Lux	10 sec - 7 min	max 6 m	360°	ABS	Blister F4	6	36

## MS012 - CIVETTA

Interruttore crepuscolare  
 Crepuscular detector switch  
 Interrupteur crépusculaire  
 Interruptor con sensor crepuscular  
 Dämmerungsschalter



MS012

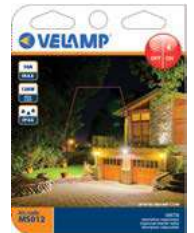

Codice Item code Code Codigo Code	Alimentazione Power source Alimentation Alimentación Stromversorgung	Altezza d'install. Installation height Hauteur d'installation Altura para instalación Installationshöhe	Assorbimento. max. Max. absorption Charge max. Carga máx. Stromaufnahme max.	Sensibilità lum. Min. ambient light Sensibilité lumineuse min. Sensibilidad luminosa min. Stromaufnahme max.	Carico max. Maximum load Charge maximale Carga máxima Maximale Last	Materiale Material Materiau Material Material	Imballo Packing Emballage Embalaje Verpackung	Inner Pcs	Master Pcs
MS012	220V ~ 50 Hz	1,8 - 2,5 m	10A	10-250 Lux	120 W (LED) (1000W for CFL Lamp)	ABS	Blister F4	6	36



## SH115 - WORLD TRAVEL ADAPTOR + USB

Adattatore da viaggio + USB  
Travel adaptor + USB  
Adaptateur de voyage + USB  
Adaptador de viaje + USB  
Adapter für Reisen + USB



SH115



Codice Prodotto Item code Code Codigo Code	Uso Use Utilisation Uso Verwendung	Materiale Material Materiu Material Material	Larghezza L1 Width Largeur Ancho Breite	Lunghezza L2 Length Longueur Lungitud Länge	Altezza L3 Height Hauteur Altura Höhe	Imballo Packing Emballage Embalaje Verpackung	Inner Pces	Master Pces
SH115	Indoor	PC	62,5 mm	57 mm	50 mm	Blister F2	6	48

## SH001 - MINI TIMER GIORNALIERO

Mini programmatore 24 ore con segmenti da 30 minuti



SH001



Codice Prodotto	Intervallo min. di programmazione	Spina	Potenza max	Uso	Materiale	Lunghezza L1	Larghezza L2	Altezza L3	Imballo	Inner Pces	Master Pces
SH001	30 min	16A	3600W	Interno	PC	54 mm	71 mm	102 mm	Blister F2	6	48

## SH005 - PROGRAMMATORE SETTIMANALE DIGITALE

Possibilità di programmare fino a 10 cicli ON/OFF al giorno  
Possibilità di programmare cicli ON/OFF diversi da un giorno all'altro  
Batteria inclusa (1xLR920)



SH005



Codice Prodotto	Intervallo min. di programmazione	Spina	Potenza max	Uso	Materiale	Lunghezza L1	Larghezza L2	Altezza L3	Imballo	Inner Pces	Master Pces
SH005	1 min	16A	3600W	Interno	PC	62 mm	71 mm	102 mm	Blister F4	6	48





## SH004

Programmatore giornaliero 24h da esterno

**NEW**

24 ORE



SPECIALE TEMPERATURE ESTREME  
-25 / +45°



SH004



Codice Prodotto	Intervallo min. di programmazione	Spina	Potenza max	Uso	Materiale	Lunghezza L1	Larghezza L2	Altezza L3	Imballo	Inner Pces	Master Pces
SH004	15 min	16A	3600W	Outdoor	PC	80 mm	70 mm	140 mm	Blister F4	6	48

## SH006

Presca elettrica con rilevatore crepuscolare e timer

**NEW**

CREPUSCOLARE  
OFF ON

TIMER  
2-4-6-8 ORE

FUNCTIONS	
OFF	ALWAYS OFF
ON	ALWAYS ON
DUSK-DAWN	☀ OFF ☾ ON
TIMER	⌚ 2 Hrs ON ⌚ 4 Hrs ON ⌚ 6 Hrs ON ⌚ 8 Hrs ON



SH006



Codice Prodotto	Intervallo min. di programmazione	Spina	Potenza max	Uso	Materiale	Lunghezza L1	Larghezza L2	Altezza L3	Imballo	Inner Pces	Master Pces
SH006	2 h	16A	1000W	Outdoor	PC	60 mm	70 mm	130 mm	Blister F4	6	48



Spina dritta 10A



PLUG-IT-10A



Codice Prodotto	Imballo	Inner Pcs	Master Pcs
PLUG-IT-10A	Bulk	25	500

Spina 90° 10A



PLUG-IT-10AK



Codice Prodotto	Imballo	Inner Pcs	Master Pcs
PLUG-IT-10AK	Bulk	25	500

Presse volante 10A



PLUG-IT-10F



Codice Prodotto	Imballo	Inner Pcs	Master Pcs
PLUG-IT-10F	Bulk	25	500

Spina dritta 16A



PLUG-IT-16A



Codice Prodotto	Imballo	Inner Pcs	Master Pcs
PLUG-IT-16A	Bulk	25	500

Spina 90° 16A



PLUG-IT-16AK



Codice Prodotto	Imballo	Inner Pcs	Master Pcs
PLUG-IT-16AK	Bulk	25	500

Presse volante 16A



PLUG-IT-16F



Codice Prodotto	Imballo	Inner Pcs	Master Pcs
PLUG-IT-16F	Bulk	25	500



Adattatore triplo 10A



ADAPT-3-10A



Codice Prodotto	Imballo	Inner Pces	Master Pces
ADAPT-3-10A	Bulk	25	200

Adattatore triplo 16A



ADAPT-3-16A



Codice Prodotto	Imballo	Inner Pces	Master Pces
ADAPT-3-16A	Bulk	25	200

Adattatore schuko 10A



ADAPT-IT-10S



Codice Prodotto	Imballo	Inner Pces	Master Pces
ADAPT-IT-10S	Bulk	25	200

Adattatore schuko 16A



ADAPT-IT-16S



Codice Prodotto	Imballo	Inner Pces	Master Pces
ADAPT-IT-16S	Bulk	25	200

Adattatore schuko + 2 prese 10A



ADAPT-3-10S



Codice Prodotto	Imballo	Inner Pces	Master Pces
ADAPT-3-10S	Bulk	25	200

Adattatore schuko + 2 prese bivalenti

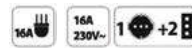

ADAPT-3-16S



Codice Prodotto	Imballo	Inner Pces	Master Pces
ADAPT-3-16S	Bulk	25	200



Multipresa con interruttore termico di sicurezza



SPINA PICCOLA 10A



MULTIT-I-102



Codice Prodotto	Lunghezza	Imballo	Inner Pces	Master Pces
MULTIT-I-102	1,5 m	Plastic hanger	5	30

Multipresa universale con cavo



MULTIT-I-S24



Codice Prodotto	Lunghezza	Imballo	Inner Pces	Master Pces
MULTIT-I-S24	1,5 m	Plastic hanger	5	25

Multipresa universale con cavo



MULTIT-I-S24K



Codice Prodotto	Lunghezza	Imballo	Inner Pces	Master Pces
MULTIT-I-S24K	1,5 m	Plastic hanger	5	25

Multipresa universale con cavo



MULTIT-I-S36



Codice Prodotto	Lunghezza	Imballo	Inner Pces	Master Pces
MULTIT-I-S36	1,5 m	Plastic hanger	5	25

Multipresa universale con cavo



MULTIT-I-S36K



Codice Prodotto	Lunghezza	Imballo	Inner Pces	Master Pces
MULTIT-I-S36K	1 m	Plastic hanger	5	25



Multipresa universale con cavo



MULTIT-I-S30



Codice Prodotto	Lunghezza	Imballo	Inner Pces	Master Pces
MULTIT-I-S30	1 m	Plastic hanger	5	25

Multipresa universale con cavo



MULTIT-I-S30K



Codice Prodotto	Lunghezza	Imballo	Inner Pces	Master Pces
MULTIT-I-S30K	1 m	Plastic hanger	5	25

Multipresa universale con cavo



MULTIT-I-S40



Codice Prodotto	Lunghezza	Imballo	Inner Pces	Master Pces
MULTIT-I-S40	1 m	Plastic hanger	5	25

Multipresa universale con cavo



MULTIT-I-S40K



Codice Prodotto	Lunghezza	Imballo	Inner Pces	Master Pces
MULTIT-I-S40K	1 m	Plastic hanger	5	25





Multipresa universale con cavo



MULTIT-I-S50



Codice Prodotto	Lunghezza	Imballo	Inner Pces	Master Pces
MULTIT-I-S50	1,5 m	Plastic hanger	5	25

Multipresa universale con cavo



MULTIT-I-S50K



Codice Prodotto	Lunghezza	Imballo	Inner Pces	Master Pces
MULTIT-I-S50K	1 m	Plastic hanger	5	25

Multipresa universale con cavo



MULTIT-I-S60



Codice Prodotto	Lunghezza	Imballo	Inner Pces	Master Pces
MULTIT-I-S60	1 m	Plastic hanger	5	25

Multipresa universale con cavo



MULTIT-I-S60K



Codice Prodotto	Lunghezza	Imballo	Inner Pces	Master Pces
MULTIT-I-S60K	1 m	Plastic hanger	5	25

Multipresa compact 6:

6 prese schuko bipasso con interruttori singoli e spina 16A salvaspazio H05VV-F 3G1mm2



**NEW**

MULTIT-I-S66



Codice Prodotto	Lunghezza	Imballo	Inner Pces	Master Pces
MULTIT-I-S66	1,5 m	Plastic hanger	5	30

Prolunga domestica



**PROLIT10A-3**



Codice Prodotto	Lunghezza	Sezione	Imballo	Inner Pces	Master Pces
<b>PROLIT10A-3</b>	3 m	3G0,75	Polybag appendibile	5	30

Prolunga domestica



**PROLIT10A-5**



Codice Prodotto	Lunghezza	Sezione	Imballo	Inner Pces	Master Pces
<b>PROLIT10A-5</b>	5 m	3G0,75	Polybag appendibile	5	30

Prolunga domestica



**PROLITS-5**



Codice Prodotto	Lunghezza	Sezione	Imballo	Inner Pces	Master Pces
<b>PROLITS-5</b>	5 m	3G1,5	Polybag appendibile	5	20

Prolunga domestica



**PROLIT10A-3K**



Codice Prodotto	Lunghezza	Sezione	Imballo	Inner Pces	Master Pces
<b>PROLIT10A-3K</b>	3 m	3G0,75	Polybag appendibile	5	30

Prolunga domestica



**PROLIT10A-5K**



Codice Prodotto	Lunghezza	Sezione	Imballo	Inner Pces	Master Pces
<b>PROLIT10A-5K</b>	5 m	3G0,75	Polybag appendibile	5	30





Prolunga domestica



PROLIT16A-3



Codice Prodotto	Lunghezza	Sezione	Imballo	Inner Pces	Master Pces
PROLIT16A-3	3 m	3G1	Polybag appendibile	5	30

Prolunga domestica



PROLIT16A-5



Codice Prodotto	Lunghezza	Sezione	Imballo	Inner Pces	Master Pces
PROLIT16A-5	5 m	3G1	Polybag appendibile	5	30

Prolunga domestica



PROLIT16A-10



Codice Prodotto	Lunghezza	Sezione	Imballo	Inner Pces	Master Pces
PROLIT16A-10	10 m	3G1	Polybag appendibile	5	30

Prolunga domestica



PROLIT16A-3K



Codice Prodotto	Lunghezza	Sezione	Imballo	Inner Pces	Master Pces
PROLIT16A-3K	3 m	3G1	Polybag appendibile	5	30

Prolunga domestica



PROLIT16A-5K



Codice Prodotto	Lunghezza	Sezione	Imballo	Inner Pces	Master Pces
PROLIT16A-5K	5 m	3G1	Polybag appendibile	5	30

Prolunga domestica



PROLIT16A-10K



Codice Prodotto	Lunghezza	Sezione	Imballo	Inner Pces	Master Pces
PROLIT16A-10K	10 m	3G1	Polybag appendibile	5	30





## DOMREEL-5-IT

Avvolgitore domestico con protezione termica  
Cavo 5m H05VV-F3G1.0mm<sup>2</sup>  
2300W max



DOMREEL-5-IT



Codice Prodotto	Tensione nominale	Cavo arrotolato	Cavo srotolato	Cavo	Lunghezza	n° prese	Materiale	Lunghezza	Larghezza	Altezza	Imballo	Master Pces
DOMREEL-5-IT	230V~	1000W	2300W	H05VV-F3G1.0mm <sup>2</sup>	5 m	4	PVC + PP	212 mm	202 mm	76 mm	Bulk	10

## DOMREEL-10-IT

Avvolgitore domestico con protezione termica  
Cavo 10m H05VV-F3G1.0mm<sup>2</sup>  
2300W max



DOMREEL-10-IT



Codice Prodotto	Tensione nominale	Cavo arrotolato	Cavo srotolato	Cavo	Lunghezza	n° prese	Materiale	Lunghezza	Larghezza	Altezza	Imballo	Master Pces
DOMREEL-10-IT	230V~	1000W	2300W	H05VV-F3G1.0mm <sup>2</sup>	10 m	4	PVC + PP	240 mm	80 mm	280 mm	Bulk	10



### REEL-IT-15

Avvolgicavo con protezione termica



15 m



REEL-IT-15



Codice Prodotto	Tensione nominale	Cavo arrotolato	Cavo srotolato	Cavo	Lunghezza	n° prese	Materiale	Lunghezza	Larghezza	Altezza	Imballo	Master Pces
REEL-IT-15	230V~	1100W	3200W	H05VV-F3G1.5mm <sup>2</sup>	15 m	4	PVC + PP	190 mm	255 mm	270 mm	Brown box	4

### REEL-IT-25

Avvolgicavo con protezione termica



25 m



REEL-IT-25



Codice Prodotto	Tensione nominale	Cavo arrotolato	Cavo srotolato	Cavo	Lunghezza	n° prese	Materiale	Lunghezza	Larghezza	Altezza	Imballo	Master Pces
REEL-IT-25	230V~	1100W	3200W	H05VV-F3G1.5mm <sup>2</sup>	25 m	4	PVC + PP	235 mm	175 mm	325 mm	Brown box	4

### REEL-IT-50

Avvolgicavo con protezione termica



50 m



REEL-IT-50



Codice Prodotto	Tensione nominale	Cavo arrotolato	Cavo srotolato	Cavo	Lunghezza	n° prese	Materiale	Lunghezza	Larghezza	Altezza	Imballo	Master Pces
REEL-IT-50	230V~	1100W	3200W	H05VV-F3G1.5mm <sup>2</sup>	50 m	4	PVC + PP	235 mm	175 mm	325 mm	Brown box	2



### REEL-22G

Avvolgicavo da giardino con protezione termica  
 Garden cable reel with thermal protection  
 Enrouleur de câble de jardin avec protection thermique  
 Enrollador de cable de jardín con protección térmica  
 Gartenseilrolle mit Wärmeschutz



20 m



REEL-22G



Codice Prodotto	Tensione nominale	Cavo arrotolato	Cavo srotolato	Cavo	Lunghezza	n° prese	Materiale	Lunghezza	Larghezza	Altezza	Imballo	Master Pces
REEL-22G	230V~	1100W	3200W	H05VV-F 2x1.5mm <sup>2</sup>	20 m	1	PP+PVC	220 mm	200 mm	310 mm	Brown box	1

### REEL-42G

Avvolgicavo da giardino con protezione termica  
 Garden cable reel with thermal protection  
 Enrouleur de câble de jardin avec protection thermique  
 Enrollador de cable de jardín con protección térmica  
 Gartenseilrolle mit Wärmeschutz



40 m



REEL-42G



Codice Prodotto	Tensione nominale	Cavo arrotolato	Cavo srotolato	Cavo	Lunghezza	n° prese	Materiale	Lunghezza	Larghezza	Altezza	Imballo	Master Pces
REEL-42G	230V~	1100W	3200W	H05VV-F 2x1.5mm <sup>2</sup>	40 m	1	PP+PVC	270 mm	180 mm	350 mm	Brown box	1

### PROHD16A-FR-20

Prolunga da giardino  
 Garden extension  
 Extension de jardin  
 Ampliación de jardín  
 Gartenerweiterung



20 m



PROHD16A-FR-20



Codice Prodotto	Lunghezza	Sezione	Imballo	Inner Pces	Master Pces
PROHD16A-FR-20	20 m	2x1,5	Polybag appendibile	-	6



Triplite frontale 3x6A

Triplite frontale 16A + 2x6A

Biplite 2P+T frontale 16A



ADAT-FR-1



Code produit Item code	Emballage Packing	Inner Pces	Master Pces
ADAT-FR-1	Bulk	10	100



ADAT-FR-2



Code produit Item code	Emballage Packing	Inner Pces	Master Pces
ADAT-FR-2	Bulk	10	100



ADAT-FR-3



Code produit Item code	Emballage Packing	Inner Pces	Master Pces
ADAT-FR-3	Bulk	10	100

Biplite 2P+T frontale 16A avec interrupteur



ADAT-FR-4



Code produit Item code	Emballage Packing	Inner Pces	Master Pces
ADAT-FR-4	Bulk	10	100

Triplite triangulaire 3x16A



TRIPLITE



Code produit Item code	Emballage Packing	Inner Pces	Master Pces
TRIPLITE	Bulk	10	60

Mini programmeur journalier 24 heures à segments



SH001H.FR



Code produit Item code	Intervalle min. de programmation Min. programming range	Fiche Plug	Puissance max Power	Utilisation Use	Matériau Material	Longueur L1 Length	Largeur L2 Width	Hauteur L3 Height	Emballage Packing	Inner Pces	Master Pces
SH001H.FR	30 min	16A	3600W	Indoor	PC	54 mm	71 mm	102 mm	Blister F2	6	48



## BLOCS MULTIPRISES



Bloc multiprise 3x10/16A (2P+T)  
Câble 1m H05VV-F3G1.0mm<sup>2</sup>



**MULTIP-FR-3**



Code produit Item code	Longueur du câble Length of cable	Emballage Packing	Inner Pcs	Master Pcs
<b>MULTIP-FR-3</b>	1 m	Plastic hanger	10	50

Bloc multiprise 4x10/16A (2P+T)  
Câble 1m H05VV-F3G1.0mm<sup>2</sup>



**MULTIP-FR-4**



Code produit Item code	Longueur du câble Length of cable	Emballage Packing	Inner Pcs	Master Pcs
<b>MULTIP-FR-4</b>	1 m	Plastic hanger	10	50

Bloc multiprise 5x10/16A (2P+T)  
Câble 1m H05VV-F3G1.0mm<sup>2</sup>



**MULTIP-FR-5**



Code produit Item code	Longueur du câble Length of cable	Emballage Packing	Inner Pcs	Master Pcs
<b>MULTIP-FR-5</b>	1 m	Plastic hanger	10	40

Bloc multiprise 3x10/16A (2P+T) avec interrupteur  
Câble 1m H05VV-F3G1.0mm<sup>2</sup>



**MULTIP-FR-I-3**



Code produit Item code	Longueur du câble Length of cable	Emballage Packing	Inner Pcs	Master Pcs
<b>MULTIP-FR-I-3</b>	1 m	Plastic hanger	10	50

Bloc multiprise 4x10/16A (2P+T) avec interrupteur  
Câble 1m H05VV-F3G1.0mm<sup>2</sup>



**MULTIP-FR-I-4**



Code produit Item code	Longueur du câble Length of cable	Emballage Packing	Inner Pcs	Master Pcs
<b>MULTIP-FR-I-4</b>	1 m	Plastic hanger	10	50

Bloc multiprise 5x10/16A (2P+T) avec interrupteur  
Câble 1m H05VV-F3G1.0mm<sup>2</sup>



**MULTIP-FR-I-5**



Code produit Item code	Longueur du câble Length of cable	Emballage Packing	Inner Pcs	Master Pcs
<b>MULTIP-FR-I-5</b>	1 m	Plastic hanger	5	40



## BLOCS MULTIPRISES



Home appliances & electric materials

Bloc 3 prises + 2 prises USB  
avec interrupteur  
Câble 1,5 m H05VV-F3G1.0mm<sup>2</sup>  
3680W. Max

Bloc 5 prises + 2 prises USB  
avec interrupteur  
Câble 1,5 m H05VV-F3G1.0mm<sup>2</sup>  
3680W. Max.



MULTIP-FR-USB3



Code produit Item code	Longueur du câble Length of cable	Emballage Packing	Inner Pces	Master Pces
MULTIP-FR-USB3	1,5 m	Plastic hanger	5	40



MULTIP-FR-USB5



Code produit Item code	Longueur du câble Length of cable	Emballage Packing	Inner Pces	Master Pces
MULTIP-FR-USB5	1,5m	Plastic hanger	5	40

Prolongateur 16A (2P+T)  
Câble H05VV-F3G1.5mm<sup>2</sup>  
3500W max



PRO16A-FR-3



PRO16A-FR-5



PRO16A-FR-10



Code produit Item code	Longueur du câble Length of cable	Emballage Packing	Inner Pces	Master Pces
PRO16A-FR-3	3 m	Plastic hanger	5	20
PRO16A-FR-5	5 m	Plastic hanger	5	20
PRO16A-FR-10	10 m	Plastic hanger	5	10



PROLONGATEURS



Prolongateur 6A  
Câble H03VVH2-F2X0.75mm<sup>2</sup>  
1250W max



PRO10A-FR-2



PRO10A-FR-5



Code produit Item code	Longueur du câble Length of cable	Emballage Packing	Inner Pcs	Master Pcs
PRO10A-FR-2	2 m	Plastic hanger	10	80
PRO10A-FR-5	5 m	Plastic hanger	10	50

Prolongateur 16A (2P+T)  
Câble 10m H07RN-F3G1.5mm<sup>2</sup>  
3500W max

Enrouleur domestique avec disjoncteur thermique.  
Câble 10m H05VV-F3G1.0mm<sup>2</sup>  
2300W max



PRO715-10F



DOMREEL-10



Code produit Item code	Longueur du câble Length of cable	Emballage Packing	Inner Pcs	Master Pcs
PRO715-10F	10 m	Plastic hanger	-	6

Code	Câble complètement enroulé	Câble complètement déroulé	Matériau	Emballage Packing	Master Pcs
DOMREEL-10	900W	2300W	PP	Bulk	10



### REEL-FR-15

Enrouleur bricolage avec disjoncteur thermique

15 m

REEL-FR-15



Code	Tension assignée	Câble complètement enroulé	Câble complètement déroulé	Câble	Longueur	Nombre de prises	Matériau	Largeur	Longueur	Hauteur	Imballo	Master Pces
REEL-FR-15	230V~	1100W	3200W	H05VV-F3G1.5mm <sup>2</sup>	15 m	4 prises 2P+T 16A	Fût et flasques: PP Support tubulaire: Acier	190 mm	255 mm	270 mm	Brown box	4

### REEL-FR-25

Enrouleur bricolage avec disjoncteur thermique

25 m

REEL-FR-25



Code	Tension assignée	Câble complètement enroulé	Câble complètement déroulé	Câble	Longueur	Nombre de prises	Matériau	Largeur	Longueur	Hauteur	Imballo	Master Pces
REEL-FR-25	230V~	1100W	3200W	H05VV-F3G1.5mm <sup>2</sup>	25 m	4 prises 2P+T 16A	Fût et flasques: PP Support tubulaire: Acier	230 mm	180 mm	360 mm	Brown box	1

### REEL-FR-40

Enrouleur bricolage avec disjoncteur thermique

40 m

REEL-FR-40



Code	Tension assignée	Câble complètement enroulé	Câble complètement déroulé	Câble	Longueur	Nombre de prises	Matériau	Largeur	Longueur	Hauteur	Imballo	Master Pces
REEL-FR-40	230V~	1100W	3200W	H05VV-F3G1.5mm <sup>2</sup>	40 m	4 prises 2P+T 16A	Fût et flasques: PP Support tubulaire: Acier	270 mm	180 mm	360 mm	Brown box	1





## MULTIMETRI DIGITALI

Digital multimeters / Multimètres digitaux / Multimetros digitales / Digitales Multimeter

### DMT600 - DIGITOP

Multimetro digitale 6 in 1  
6 in 1 Digital multimeter  
Multimètre digital 6 en 1  
Multimetro digital 6 en 1  
Digitales Multimeter 6 in 1

CE SGS

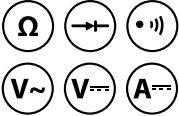

DMT600



COD.	DESCRIZIONE	Packing	Inner Pcs	Master Pcs
DMT600	68,5 x 124 x 27 mm	Blister	6	60

### DMT700 - DIGITOP

Multimetro digitale 7 in 1  
7 in 1 Digital multimeter  
Multimètre digital 7 en 1  
Multimetro digital 7 en 1  
Digitales Multimeter 7 in 1

CE SGS

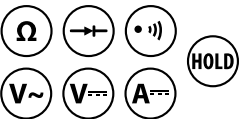

DMT700



COD.	DESCRIZIONE	Packing	Inner Pcs	Master Pcs
DMT700	78,5 x 130 x 33 mm	Blister	6	60

Home appliances & electric materials



## CF001 VOLTAGE TESTER XL

Cercafase 140mm  
Voltage tester  
Testeur de voltage  
Medidores de tensión  
Phasenprüfer

140 mm



CF001



COD.	LENGTH	Packing	Inner Pces	Master Pces
CF001	140 mm	Plastic hanger	12	288



## CF002 VOLTAGE TESTER XXL

Cercafase 190 mm  
Voltage tester  
Testeur de voltage  
Medidores de tensión  
Phasenprüfer

190 mm



CF002



COD.	LENGTH	Packing	Inner Pces	Master Pces
CF002	190 mm	Plastic hanger	12	288



## MORSETTIERE PER CAVI ELETTRICI

Terminals blocks / Bornes de raccordement / Regleta Clema / Anschlussklemme für elektrische Kontakte















## MORSETTIERE PER CAVI ELETTRICI

Terminals blocks / Bornes de raccordement / Regleta Clema / Anschlussklemme für elektrische Kontakte



All models except  
MG301



Codice Item code Code Codigo Code	A	Dimensioni Dimensions Dimensions Abmessungen	Materiale Materials Materiau Material	Codice ean Ean code Ean code Ean code Ean code	Imballo Packing Emballage Embalaje Verpackung	Inner Pces	Master Pces
MG303	3A	4 mm <sup>2</sup>	PP	 = 	Shrink 10 pcs = 	100	1000
MG306	6A	6 mm <sup>2</sup>	PP	 = 	Shrink 10 pcs = 	100	1000
MG310	10A	10 mm <sup>2</sup>	PP	 = 	Shrink 10 pcs = 	100	800
MG330	30A	16 mm <sup>2</sup>	PP	 = 	Shrink 10 pcs = 	100	400
MG360	60A	25 mm <sup>2</sup>	PP	 = 	Shrink 10 pcs = 	100	200



## FASCETTE PER CABLAGGIO IN NYLON 6.6

Nylon Cable ties / Serre-câbles en nylon / Bridas Nylon / Nylonkabelbinder

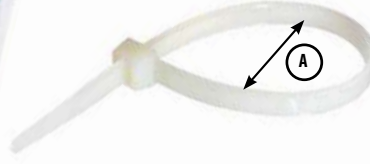

Codice Item code Code Codigo Code	Diametro massimo Max diameter A	Dimensioni Dimensions Dimensions Dimensiones Abmessungen	Materiale Material Materiu Material Material	Imballo Packing Emballage Embalaje Verpackung	Inner Pces	Master Pces	Codice ean Ean code Ean code Ean code Ean code
MG101	max 22 mm	2,5 x 100 mm	Nylon 6.6	Polybag 100 pcs	10	500	8 003910 101173 >
MG102	max 35 mm	2,5 x 150 mm	Nylon 6.6	Polybag 100 pcs	10	350	8 003910 101180 >
MG103	max 53 mm	2,5 x 200 mm	Nylon 6.6	Polybag 100 pcs	10	300	8 003910 101197 >
MG111	max 53 mm	3,6 x 200 mm	Nylon 6.6	Polybag 100 pcs	10	200	8 003910 101210 >
MG112	max 70 mm	3,6 x 280 mm	Nylon 6.6	Polybag 100 pcs	10	160	8 003910 101227 >
MG113	max 26 mm	4,6 x 120 mm	Nylon 6.6	Polybag 100 pcs	10	200	8 003910 101272 >
MG120	max 53 mm	4,8 x 200 mm	Nylon 6.6	Polybag 100 pcs	10	140	8 003910 101234 >
MG121	max 82 mm	4,8 x 300 mm	Nylon 6.6	Polybag 100 pcs	10	100	8 003910 101241 >
MG122	max 90 mm	4,8 x 350 mm	Nylon 6.6	Polybag 100 pcs	10	90	8 003910 101258 >
MG130	max 160 mm	7,6 x 550 mm	Nylon 6.6	Polybag 50 pcs	5	50	8 003910 101265 >
MG140	max 33 mm	6,8 x 150 mm	Nylon 6.6	Polybag 50 pcs	5	200	8 003910 101288 >

## FASCETTA BIANCA PER CABLAGGIO IN NYLON RIAPRIBILE

White releasable nylon cable ties / Serre-câbles blancs, en nylon, réutilisables / Bridas de cables reutilizables blancas, de nylon / Kabelbinder Nylon weiss mit Verschiebevorrichtung

Codice Item code Code Codigo Code	Diametro massimo Max diameter A	Dimensioni Dimensions Dimensions Dimensiones Abmessungen	Materiale Material Materiu Material Material	Imballo Packing Emballage Embalaje Verpackung	Inner Pces	Master Pces	Codice ean Ean code Ean code Ean code Ean code
MG199	max 35 mm	7,5 x 150 mm	Nylon 6.6	Polybag 50 pcs	5	200	8 003910 101319 >

**FASCETTE PER CABLAGGIO IN NYLON 6.6**  
Nylon Cable ties / Serre-câbles en nylon / Bidas Nylon / Nylonkabelbinder



Codice Item code Code Codigo Code	Diametro massimo Max diameter A	Dimensioni Dimensions Dimensions Dimensiones Abmessungen	Materiale Material Materiu Material Material	Imballo Packing Emballage Embalaje Verpackung	Inner Pces	Master Pces	Codice ean Ean code Ean code Ean code Ean code
MG201	max 22 mm	2,5 x 100 mm	Nylon 6.6	Polybag 100 pcs	10	500	8 003910 101074 >
MG202	max 35 mm	2,5 x 150 mm	Nylon 6.6	Polybag 100 pcs	10	350	8 003910 101081 >
MG203	max 53 mm	2,5 x 200 mm	Nylon 6.6	Polybag 100 pcs	10	300	8 003910 101098 >
MG211	max 53 mm	3,6 x 200 mm	Nylon 6.6	Polybag 100 pcs	10	200	8 003910 101111 >
MG212	max 70 mm	3,6 x 280 mm	Nylon 6.6	Polybag 100 pcs	10	160	8 003910 101128 >
MG220	max 53 mm	4,8 x 200 mm	Nylon 6.6	Polybag 100 pcs	10	140	8 003910 101135 >
MG221	max 82 mm	4,8 x 300 mm	Nylon 6.6	Polybag 100 pcs	10	100	8 003910 101142 >
MG222	max 90 mm	4,8 x 350 mm	Nylon 6.6	Polybag 100 pcs	10	90	8 003910 101159 >
MG230	max 160 mm	7,6 x 550 mm	Nylon 6.6	Polybag 50 pcs	5	50	8 003910 101166 >

**FASCETTE PER CABLAGGIO IN NYLON 6.6**

Nylon Cable ties / Serre-câbles en nylon / Bridas Nylon / Nylonkabelbinder

Home appliances & electric materials

**NEW**

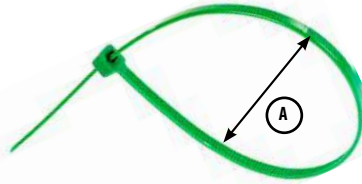

Codice Item code Code Codigo Code	Diametro massimo Max diameter A	Dimensioni Dimensions Dimensions Dimensions Abmessungen	Materiale Material Materiu Material Material	Imballo Packing Emballage Embalaje Verpackung	Inner Pces	Master Pces	Codice ean Ean code Ean code Ean code Ean code
MG272	max 22 mm	2,5 x 100 mm	Nylon 6.6	Polybag 100 pcs	10	500	8 003910 110212 >
MG271	max 53 mm	4,8 x 200 mm	Nylon 6.6	Polybag 100 pcs	10	140	8 003910 110205 >

**NEW**



**6 Colours available**



Kit contents:

2.5 x 100mm black, white, orange, yellow, green (60 pieces each),  
2.5 x 150mm red, yellow (50 pieces each),  
2.5 x 200mm white (50 pieces each), 3.6 x 200 mm black (50 pieces).

Codice Item code Code Codigo Code	Dimensioni Dimensions Dimensions Dimensions Abmessungen	Materiale Material Materiu Material Material	Imballo Packing Emballage Embalaje Verpackung	Inner Pces	Master Pces	Codice ean Ean code Ean code Ean code Ean code
MG280	<b>2,5 x 100 mm</b> black 60 pcs white 60 pcs orange 60 pcs yellow 60 pcs green 60 pcs  <b>2,5 x 150 mm</b> red 50 pcs yellow 50 pcs  <b>2,5 x 200 mm</b> white 50 pcs  <b>3,6 x 200 mm</b> black 50 pcs	Nylon 6.6	Plastic tube 500 pcs	10	40	8 003910 110193 >

## ACCESSORI VARI

Electrical accessories / Accessoires divers / Varios accesorios / Verschiedenes Zubehör

### CIP681

Connettore due poli IP68  
Connecteur IP68  
IP68 connector  
Conector bipolar IP68  
IP68 Verbinder für die Außenverkabelung



CIP681



Codice Prodotto	Imballo	Inner Pces	Master Pces
CIP681	Polybag appendibile	12	192

### CIP682

Connettore a T IP68  
Connecteur IP68  
IP68 connector  
IP68 Verbinder für die Außenverkabelung  
Conector en T IP68



CIP682



Codice Prodotto	Imballo	Inner Pces	Master Pces
CIP682	Polybag appendibile	12	96

### CIP607

Scatola di protezione spina e presa volante  
Waterproof box for sockets and plugs  
Boitier de protection étanche pour prises  
Caja de protección para clavija y toma  
Sicherheitsbox



CIP607



Codice Prodotto	Imballo	Inner Pces	Master Pces
CIP607	Shrink	10	50

### LHGU10

Portalamпада in ceramica per microiche / GU10  
con cavo 15 cm 2x0,75mm<sup>2</sup>  
Ceramic lamp holder for GU10 bulbs. With 15 cm 2x0,75mm<sup>2</sup> cable  
Douille GU10 en céramique avec câble 15 cm 2x0,75mm<sup>2</sup>  
Portalamparas  
Lampenfassung in Keramik für Dichroic LED / GU10 mit 15cm x 0,75mm 2 Kabel



LHGU10



Codice Prodotto	Imballo	Inner Pces	Master Pces
LHGU10	Bulk	50	1000

### START22

Starter 4-22W



4-22W

START22



Codice Prodotto	Imballo	Inner Pces	Master Pces
START22	Bulk	50	2000

### START65

Starter 4-65W



4-65W

START65



Codice Prodotto	Imballo	Inner Pces	Master Pces
START65	Bulk	50	2000

# CAT5E

## NETWORK CABLES

UTP Cat.5E Network cable  
CCA/PE High Density  
PVC 5.0 mm (external)



**305 meters**  
(1000 feet)

LANSEU-305



Codice Prodotto	Lunghezza	Imballo	Inner Pcs	Master Pcs
LANSEU-305	300m	Pull box	-	2

UTP Cat.5E Network cable  
CCA/PE High Density  
PVC 5.0 mm (external)



**100 meters**  
(328 feet)

LANSEU-100



Codice Prodotto	Lunghezza	Imballo	Inner Pcs	Master Pcs
LANSEU-100	100m	Shrink	-	4

FTP Cat.5E Network cable  
CCA/PE High Density  
PVC 5.0 mm (external)



**305 meters**  
(1000 feet)

LANSEF-305



Codice Prodotto	Lunghezza	Imballo	Inner Pcs	Master Pcs
LANSEF-305	300m	Pull box	-	2



Router



Computer



Printer



Office



Gaming



TV



CCTV



Voip

Connettori RJ45 CAT5E UTP da crimpare  
RJ45 CAT5E UTP crimp connectors  
Connecteurs RJ45 CAT5E UTP à sertir  
Conectores RJ45 CAT5E UTP para crimpar  
RJ45 CAT5E UTP Crimp Verbinder

**X 100**



LANCSU-100



Codice Prodotto	Pcs x imballo	Imballo	Inner Pcs	Master Pcs
LANCSU-100	100	Polybag	-	25

Connettori blindati RJ45 CAT5E FTP da crimpare  
RJ45 CAT5E FTP shielded crimp connectors  
Connecteurs blindés RJ45 CAT5E FTP à sertir  
Conectores RJ45 blindados CAT5E FTP para crimpar  
RJ45 CAT5E FTP Geschirmter Crimp-Verbinder

**X 100**



LANCSF-100



Codice Prodotto	Pcs x imballo	Imballo	Inner Pcs	Master Pcs
LANCSF-100	100	Polybag	-	25



NETWORK CABLES

CAT6



UTP Cat.6 Network cable  
CCA/PE High Density  
PVC 6.0 mm (external)



**305 meters**  
(1000 feet)

UTP Cat.6 Network cable  
CCA/PE High Density  
PVC 6.0 mm (external)



**100 meters**  
(328 feet)

LAN6U-305



LAN6U-100



Codice Prodotto	Lunghezza	Imballo	Inner Pcs	Master Pcs
LAN6U-305	300m	Pull box	-	2

Codice Prodotto	Lunghezza	Imballo	Inner Pcs	Master Pcs
LAN6U-100	100m	Shrink	-	4

FTP Cat6 Network cab  
CCA/PE High Density  
PVC 6.0 mm (external)



**305 meters**  
(1000 feet)

LAN6F-305



Codice Prodotto	Lunghezza	Imballo	Inner Pcs	Master Pcs
LAN6F-305	300m	Pull box	-	2

Connettori RJ45 CAT6 UTP da crimpare  
RJ45 CAT6 UTP crimp connectors  
Connecteurs RJ45 CAT6 UTP à sertir  
Conectores RJ45 CAT6 UTP para crimpar  
RJ45 CAT6 UTP Crimp Verbinder

**X 100**



LANC6U-100



Codice Prodotto	Pcs x imballo	Imballo	Inner Pcs	Master Pcs
LANC6U-100	100	Polybag	-	25



Connettori blindati RJ45 CAT6 FTP da crimpare  
RJ45 CAT6 FTP shielded crimp connectors  
Connecteurs blindés RJ45 CAT6 FTP à sertir  
Conectores RJ45 blindados CAT6 FTP para crimpar  
RJ45 CAT6 FTP Geschirmter Crimp-Verbinder

**X 100**



LANC6F-100



Codice Prodotto	Pcs x imballo	Imballo	Inner Pcs	Master Pcs
LANC6F-100	100	Polybag	-	25

Home appliances & electric materials

## DL101

Lampada da lavoro 24 led con gancio e calamita  
24 LED work light with hook and magnet  
Lampe de travail 24 LED avec aimant et crochet  
Lámpara para taller 24LED con iman y gancho  
Arbeitslampe 24 LED mit Haken und Magnet



DL101



COD.									+	Packing	Inner Pcs	Master Pcs
DL101	24 + 4 LED	12Lm	20 mt	16 hrs	Diffuse light	90 x 55 x 35 mm	3 x AAA/LR03 (not included)	Rubber ABS	Magnet Hook	Display 12 pcs	12	96

## DL104 - R2D2

Torcia LED + pannello luminoso COB. Con gancio e magnete.  
2 in 1 LED work light. With hook and magnet  
Lampe de travail LED 2 en 1. Avec aimant et crochet  
Linterna LED + Panel LED COB. Con gancho y imán  
LED-Taschenlampe + COB-Lichtpanel. Mit Haken und Magnet.



DL104



COD.									+	Packing	Inner Pcs	Master Pcs
DL104	3W LED COB	150Lm	10 mt	15 hrs	Focus + Diffuse light	69 x 98 x 34 mm	3 x AAA/LR03 (not included)	ABS	Magnet Hook	Display 12 pcs	12	96

## ESPOSITORI DA BANCO

Displays / Présentoirs / Expositores / Display

### IS463

Lampada da lavoro COB LED con gancio e calamita  
 COB LED work light with hook and magnet  
 Lampe de travail COB LED avec aimant et crochet  
 Lámpara para taller COB LED con iman y ganche  
 Arbeitslampe COB LED mit Haken und Magnet



IS463



COD.								+	Packing	Inner Pcs	Master Pcs
IS463	3W COBLED	200 Lm	8 hrs	Diffuse light	205 x 50 x 25 mm	4 x AAA/LR03 (not included)	ABS	Magnet Hook	Display 12 pcs	12	72

### IN322 - GRAM

Torcia 3 LED ricaricabile con dinamo  
 3 LED Hand Press Crank  
 Torche 3 LED avec dynamo  
 Linterna recargable de 3 LED con dínamo  
 Wiederaufladbare 3W LED-Leuchte mit Dynamo



IN322



COD.								+	Packing	Inner Pcs	Master Pcs
IN322	3 Standard LED	10 Lm	30 min	Diffuse	100 x 25 x 50 mm	3 x LR1130	ABS	Wrist band	Display 12 pcs	12	48

## DL202 - STICK

Torcia LED in ABS  
ABS LED flashlight  
Lampe torche LED en ABS  
Linterna ABS LED  
LED-Taschenlampe aus ABS



DL202



COD.									Packing	Inner Pces	Master Pces
DL202	1W SMD LED	60 Lm	10 m	24 hrs	Focus light	ø35 x 153 mm	2 x AA/ LR6 (not included)	ABS	Display 12 pcs	12	96

## IN238 - ACID

Torcia metallica 1 LED con clip  
1 LED metal flashlight with clip  
Torche métallique 1 LED avec clip  
Mini Linterna 1 LED con clip  
Metalltaschenlampe 1 LED mit Clip



IN238



COD.									+	Packing	Inner Pces	Master Pces
IN238	1 High power LED 0,5W	20 Lm	20 mt	30 hrs	Focus light	95 x ø 20 mm	1 x AA/LR6 (not included)	AL	Clip	Display 12 pcs	12	48

## ESPOSITORI DA BANCO

Displays / Présentoirs / Expositores / Display

### D86 - KALIBRO

Torcia LED in ABS  
 ABS LED flashlight  
 Lampe torche LED en ABS  
 Linterna ABS LED  
 LED-Taschenlampe aus ABS

**NEW**



COB  
LED

12 pcs  
DISPLAY



D86



COD.										Packing	Inner Pces	Master Pces
D86	2W COB LED	110 Lm	20 mt	12 hrs	Diffuse light	ø29 x 97 mm	3 x AAA/ LR03 (not included)	ABS	Wrist band	Display 12 pcs	12	48

### D85 - ODIN

Pochet lamp  
 Pocket lamp  
 Lampe de poche  
 Linterna de mano  
 Taschenlampe



12 pcs  
DISPLAY



D85



COD.										Packing	Inner Pces	Master Pces
D85	3W LED	120 Lm	110 mt	10 hrs	Focus light	35,5ø x 114 mm	3 AAA/LR6 (not included)	AL	Wrist band	Display 12 pcs	12	96

## D89 - THOR

Torcia LED con zoom + lanterna COB  
Flashlight with zoom + COB lantern  
Torche LED avec zoom + lanterne COB  
Linterna portátil LED COB  
Taschenlampe mit COB LED Panel



D89



COD.										Packing	Inner Pcs	Master Pcs
D89	1W LED	80 Lm	30 mt	5 hrs	Focus light Diffuse light	23 ø x 108 mm	1 AA/LR6 (not included)	AL	Clip	Display 12 pcs	12	96

## IN256 - BIG DADDY

Torcia cc  
COB flash  
Torche LE  
Linterna  
Taschenk



IN256



COD.								Packing	Inner Pcs	Master Pcs
IN256	3W COB LED / red blink	400 Lm	30 hrs	Diffuse light	191 x ø 33 mm	3 x AA / LR6 (not included)	AL	Display 12 pcs	12	48

## ESPOSITORI DA BANCO

Displays / Présentoirs / Expositores / Display

### IN221 - SURF

Portachiavi con pannello LED COB

COB LED keychain

Porte-clef LED COB

Ilavero con Luz LED COB

Schlüsselanhängen mit COB-LED-Panel

LED  
COB



IN221



COD.								+	Packing	Inner Pcs	Master Pcs
IN221	3W COB LED	100Lm	15 hrs	Diffuse light	70 x 35 x 15 mm	3 x AAA/ LR03 (not included)	ABS	Magnet	Display 12 pcs	12	48

### IN239 - MAVERICK

Torcia metallica 1 LED con clip

1 LED metal flashlight with clip

Torche métallique 1 LED avec clip

Mini Linterna 1 LED con clip

Metalltaschenlampe 1 LED mit Clip



IN239



COD.								Packing	Inner Pcs	Master Pcs
IN239	1 High power LED 0,2W	20Lm	10 hrs	Focus light	146 x 90 x 118 mm	1 x AAA/ LR03 (not included)	AL	Display 12 pcs	12	48

## IN229 - RED DOT 2

Puntatore laser con luce LED e UV  
Laser + LED + UV keychain  
Porte-cléfs pointeur + lumière LED + UV  
Super puntero Laser + luz LED+UV con llavero  
Laserpointer + LED + UV



IN229



COD.									Packing	Inner Pcs	Master Pcs
IN229	1 white LED 1 UV light 1 RED Laser	5 Lm	2 mt	29 hrs	Focus light	13 x 15 x 75 mm	3 x LR44 (included)	AL	Display 24 pcs	24	192

## IC207 - PUSHUP

Mini lanterna 3W  
Mini camping lantern 3 W  
Mini lanterne de camping 3W  
Mini linterna de camping 3 W  
Mini Campinglampe 3 W



IC207



COD.								Packing	Inner Pcs	Master Pcs
IC207	3W LED	200 Lm	5 hrs	Diffuse Light	97 x 68ø mm	3 x AAA/LR03 (not included)	ABS	Display 6 pcs	12	48



## ESPOSITORI DA BANCO

Displays / Présentoirs / Expositores / Display

### D83 - GYVER

Pinza multiuso  
Multitool  
Pinces multifonction  
Alicates multiherramientas  
Multifunktionale Zange

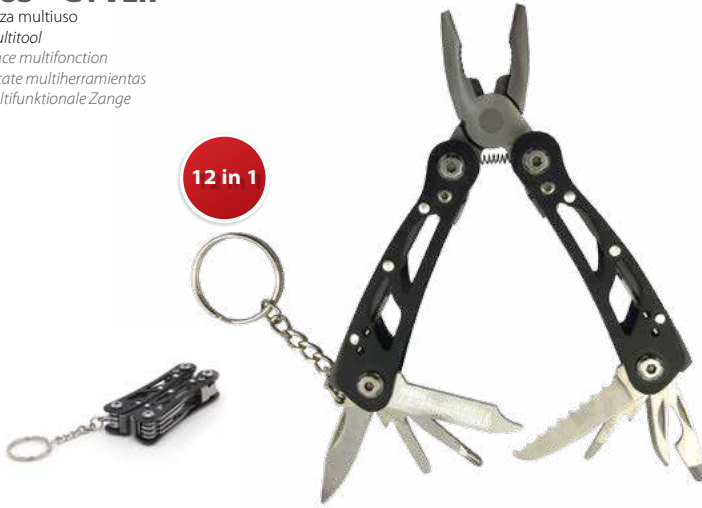

**NEW**

12 pcs  
DISPLAY



D83



COD.	Functions	Dimensioni	Materiale	Packing	Inner Pcs	Master Pcs
D83	Regular Pliers, Wire cutters, Mini flat screwdriver, Phillips Screwdriver, Big Sharp Knife, Filer, Punch needle, Saw, Sharp Knife, Can Opener, Maxi flat screwdriver, Keyring	42 x 17 x 71 mm	Metal	Display 12pcs	12	48

### IL01 - LUMINO RIUTILIZZABILE

Lumino votivo riutilizzabile a batterie  
Battery operated votive light  
Lumière votive à piles  
Lumino votivo LED de batería electrónica  
Votivlicht batteriebetrieben



REUSABLE

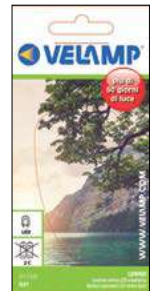

IL01



COD.	LED	Lumen	Tempo	Funzione	Dimensioni	Batteria	Materiale	Packing	Inner Pcs	Master Pcs
IL01	1 LED	5 Lm	15 days	Luce fissa (Fixed light)	115 x ø70 mm	2 x C / R14 (not included)	ABS	Color box	12	48

**IL019-R - LUMINO GRANDE**

Lumino votivo a batterie incluse "usa e getta"

Battery operated disposable votive light

Lumière votive jetable avec piles incluses

Lumino votivo LED desechable

„Einweg“-Votivlicht batteriebetrieben

**3 SOGGETTI ASSORTITI**  
**3 ASSORTED PICTURES**

IL019-R



COD.							Packing	Inner Pces	Master Pces
IL019-R	1 LED	90 days	Luce fissa (Fixed light)	152 x ø67 mm	2 x AA / LR6 (included)	PP+PET	Bulk	-	30

**IL019-B - LUMINO GRANDE**

Lumino votivo a batterie incluse "usa e getta"

Battery operated disposable votive light

Lumière votive jetable avec piles incluses

Lumino votivo LED desechable

„Einweg“-Votivlicht batteriebetrieben

**3 SOGGETTI ASSORTITI**  
**3 ASSORTED PICTURES**

IL019-B



COD.							Packing	Inner Pces	Master Pces
IL019-B	1 LED	120 days	Luce fissa (Fixed light)	152 x ø67 mm	2 x AA / LR6 (included)	PP+PET	Bulk	-	30

## LUMINI VOTIVI

Votive lights / Lumières votives / Velas votivas / Votivlichter



### IL018-R - LUMINO MEDIO

Lumino votivo a batterie incluse "usa e getta"

Battery operated disposable votive light

Lumière votive jetable avec piles incluses

Lumino votivo LED desechable

„Einweg“-Votivlicht batteriebetrieben



**3 SOGGETTI ASSORTITI**  
**3 ASSORTED PICTURES**

IL018-R



COD.							Packing	Inner Pces	Master Pces
IL018-R	1 LED	60 days	Luce intermittente (Blinking light)	129 x ø67 mm	2 x AA / R6 (included)	PP+PET	Bulk	-	30

### IL013-R - LUMINO PICCOLO

Lumino votivo a batterie incluse "usa e getta"

Battery operated disposable votive light

Lumière votive jetable avec piles incluses

Lumino votivo LED desechable

„Einweg“-Votivlicht batteriebetrieben



**3 SOGGETTI ASSORTITI**  
**3 ASSORTED PICTURES**

IL013-R



COD.							Packing	Inner Pces	Master Pces
IL013-R	1 LED	90 days	Luce fissa (Fixed light)	90 x ø 50 mm	2 x AA / LR6 (included)	PP	Bulk	-	20

**IL017 - ETERNITY**

Lumino votivo a batterie incluse "usa e getta"  
 Battery operated disposable votive light  
 Lumière votive jetable avec piles incluses  
 Lumino votivo LED desechable  
 „Einweg“-Votivlicht batteriebetrieben



**365**  
giorni  
di luce

IL017



COD.							Packing	Inner Pces	Master Pces
IL017	1 LED	365 days	Luce intermittente (Blinking light)	150 x ø 70 mm	1 x C / LR14 (included)	ABS+Glass	Bulk	-	8

**IL016 - INFINITY**

Lumino votivo a batterie incluse "usa e getta"  
 Battery operated disposable votive light  
 Lumière votive jetable avec piles incluses  
 Lumino votivo LED desechable  
 „Einweg“-Votivlicht batteriebetrieben



**365**  
giorni  
di luce

IL016



**3 SOGGETTI ASSORTITI**  
**3 ASSORTED PICTURES**

COD.							Packing	Inner Pces	Master Pces
IL016	1 LED	365 days	Luce intermittente (Blinking light)	100 x ø30 mm	2 x AA / LR6 (included)	PP	Bulk	6	18



**Batteries**



R03/4BP



R6/4BP



COD.	Type	Technology	Voltage (V)	Inner (pcs)	Master (pcs)
R03/4BP	AAA/MINISTILO/R03	Zinc-Carbon	1,5	12	144

COD.	Type	Technology	Voltage (V)	Inner (pcs)	Master (pcs)
R6/4BP	AA/STILO/R6	Zinc-Carbon	1,5	12	144



R14/2BP



R20/2BP



COD.	Type	Technology	Voltage (V)	Inner (pcs)	Master (pcs)
R14/2BP	C/1/2 TORCIA/R14	Zinc-Carbon	1,5	12	72

COD.	Type	Technology	Voltage (V)	Inner (pcs)	Master (pcs)
R20/2BP	D / TORCIA/R20	Zinc-Carbon	1,5	10	60



3R12/1BP



4R25/1B



COD.	Type	Technology	Voltage (V)	Inner (pcs)	Master (pcs)
3R12/1BP	3R12/PIATTA/3R12	Zinc-Carbon	4,5	10	120

COD.	Technology	Voltage (V)	Master (pcs)	Pallet (pcs)
4R25/1B	Zinc-Carbon	6V	24	1152

# PILE ALKALINE

Alkaline / Alkaline / Alkalinas / Alkaline



LR03/4BP



COD.	Type	Technology	Voltage (V)	Inner (pcs)	Master (pcs)
LR03/4BP	AAA/MINISTILO/LR03	Alkaline	1,5	12	144



LR6/4BP



COD.	Type	Technology	Voltage (V)	Inner (pcs)	Master (pcs)
LR6/4BP	AA/STILO/LR6	Alkaline	1,5	12	144



LR03/8BP



COD.	Type	Technology	Voltage (V)	Inner (pcs)	Master (pcs)
LR03/8BP	AAA/MINISTILO/LR03	Alkaline	1,5	10	120



LR6/8BP



COD.	Type	Technology	Voltage (V)	Inner (pcs)	Master (pcs)
LR6/8BP	AA/STILO/LR6	Alkaline	1,5	10	60

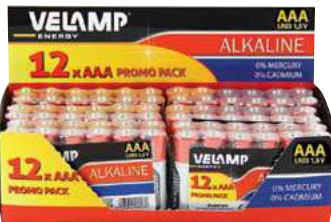

LR03/12PACK



COD.	Type	Technology	Voltage (V)	Inner (pcs)	Master (pcs)
LR03/12PACK	AAA/MINISTILO/LR03	Alkaline	1,5	6	96



LR6/12PACK



COD.	Type	Technology	Voltage (V)	Inner (pcs)	Master (pcs)
LR6/12PACK	AA/STILO/LR6	Alkaline	1,5	6	48



LR03/24BOX



COD.	Type	Technology	Voltage (V)	Inner (pcs)	Master (pcs)
LR03/24BOX	AAA/MINISTILO/LR03	Alkaline	1,5	6	48



LR6/24BOX



COD.	Type	Technology	Voltage (V)	Inner (pcs)	Master (pcs)
LR6/24BOX	AA/STILO/LR6	Alkaline	1,5	6	36



LR14/2BP



COD.	Type	Technology	Voltage (V)	Inner (pcs)	Master (pcs)
LR14/2BP	C/1/2 TORCIA/LR14	Alkaline	1,5	12	72



LR20/2BP



COD.	Type	Technology	Voltage (V)	Inner (pcs)	Master (pcs)
LR20/2BP	D/TORCIA/LR20	Alkaline	1,5	10	60



6LR61/1BP



COD.	Type	Technology	Voltage (V)	Inner (pcs)	Master (pcs)
6LR61/1BP	9V / TRANSISTOR/6LR61	Alkaline	9	12	144



LR23A



COD.	Type	Technology	Voltage (V)	Inner (pcs)	Master (pcs)
LR23A	12V/TELECOMANDO/23A	Alkaline	12	12	144



## PILE LITIO

Lithium / Lithium / Litio / Lithium

### B23716

Batteria al litio ricaricabile  
Rechargeable lithium battery  
Batterie Lithium rechargeable  
Bateria al Litio recargable  
Wiederaufladbare Lithium-Batterie



### 23717.R

Batteria al litio ricaricabile  
Rechargeable lithium battery  
Batterie Lithium rechargeable  
Bateria al Litio recargable  
Wiederaufladbare Lithium-Batterie



B23716



COD.	Type	Technology	Voltage (V)	Capacity (mAh)	Inner (pcs)	Master (pcs)
B23716	18650	Lithium	3.7V	2200mAh	12	192

23717.R



COD.	Type	Technology	Voltage (V)	Capacity (mAh)	Inner (pcs)	Master (pcs)
23717.R	18650	Lithium	3.7V	3250mAh	5	50

### CBT06

Carica batterie  
Battery charger  
Chargeur de batterie  
Cargador de batería  
Akkuladegerät

Only for  
Li-ion  
batteries



CBT06



COD.	Dimensions (mm)	Packing	Inner (pcs)	Master (pcs)
CBT06	45 x 29 x 101 mm	Colour box	6	24

### BATTIR867

Batteria al litio ricaricabile  
Rechargeable lithium battery  
Batterie Lithium rechargeable  
Bateria al Litio recargable  
Wiederaufladbare Lithium-Batterie

FOR IR867



BATTIR867



COD.	Type	Technology	Voltage (V)	Capacity (mAh)	Inner (pcs)	Master (pcs)
BATTIR867	18650x2	Lithium	7.4V	4400mAh	10	10

### BATTIR666

Batteria al litio ricaricabile  
Rechargeable lithium battery  
Batterie Lithium rechargeable  
Bateria al Litio recargable  
Wiederaufladbare Lithium-Batterie

FOR DOOMSTER SERIES



BATTIR666



COD.	Type	Technology	Voltage (V)	Capacity (mAh)	Inner (pcs)	Master (pcs)
BATTIR666	18650	Lithium	3.7V	2200mAh	5	50



**BATT3744**

Batteria al litio ricaricabile  
 Rechargeable lithium battery  
 Batterie Lithium rechargeable  
 Bateria al Lito recargable  
 Wiederaufladbare Lithium-Batterie



BATT3744



**BATT7480**

Batteria al litio ricaricabile  
 Rechargeable lithium battery  
 Batterie Lithium rechargeable  
 Bateria al Lito recargable  
 Wiederaufladbare Lithium-Batterie



BATT7480



COD.	Type	Technology	Voltage (V)	Capacity (mAh)	Inner (pcs)	Master (pcs)
BATT3744	18650x2	Lithium	3,7V	4400mAh	5	50

COD.	Type	Technology	Voltage (V)	Capacity (mAh)	Inner (pcs)	Master (pcs)
BATT7480	18650x8	Lithium	7,4V	8000mAh	5	50

**COMPATIBILITA' BATTERIE / BATTERY COMPATIBILITY**

CODICE CODE	4R25	LR20	BATTIR666 Li-ion 3.7V 2Ah	23716.R Li-ion 3.7 2.2Ah	B23716 Li-ion 3.7 2.2Ah	23717.R Li-ion 3.7V 3250mAh	BATT3744 Li-ion 3.7V 4.4Ah	BATTIR867 Li-ion 7.4V 4Ah	BATT7480 Li-ion 7.4V 8Ah	23722 Pb 6V 4Ah
IR554			√				√			
IR558			√				√			
IR666-5W			√				√			
IR666-10W			√				√			
ST999-5L			√				√			
ST999-10L			√				√			
R930								√		
IR867								√		
IR882			√				√			
IS342				√	√	√				
ST223								√	√	
ST225								√	√	
SL320				√	√	√				
SL420				√	√	√				
SL2048				√	√	√				
PS0705				√	√	√				
SL237				√	√	√				
SL238				√	√	√				
SL368				√	√	√				
SL360				√	√	√				
SI362				√	√	√				
IS340				√	√	√				
IMR90				√	√	√				
ST201				√	√	√				
IR547				√	√	√				
IR666-DRY	√	√								
R920										√

## BATTERIE AL PIOMBO RICARICABILI

Rechargeable lead acid batteries / Batteries au plomb rechargeables / Baterias recargables al plomo / Wiederaufladbare Bleibatterien



## CR24X

24 pieces button cell set

CR2025



COD.	Type	Technology	Voltage (V)	Capacity (mAh)	Inner (pcs)	Master (pcs)
CR2025	Button Cell	Lithium	3		50	1000

CR2016



COD.	Type	Technology	Voltage (V)	Capacity (mAh)	Inner (pcs)	Master (pcs)
CR2016	Button Cell	Lithium	3	75	50	1000

CR2032

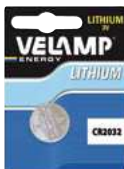

COD.	Type	Technology	Voltage (V)	Capacity (mAh)	Inner (pcs)	Master (pcs)
CR2032	Button Cell	Lithium	3	210	50	1000



CR24X



COD.	Type	Technology	Voltage (V)	Capacity (mAh)	Inner (pcs)	Master (pcs)
CR24X	Button Cell	Lithium / Alkaline	1,5V / 3V	AG1/364/LR621 13mAh x2 AG3/392/LR41 40mAh x2 AG4/377/LR626 19mAh x2 AG5/393/LR754 60mAh x2 AG8/391/LR1120 45mAh x2 AG10/389/LR1130 70mAh x2 AG12/386/LR43 100mAh x2 AG13/357/LR44 150mAh x2 CR1620 / 70mAh x2 CR2016 / 70mAh x2 CR2025 / 150mAh x2 CR2032 / 200mAh x2	25	100

## BATTERIE RICARICABILI

Rechargeable / Rechargeables / Recargables / Wiederaufladbar

HR03/4BP

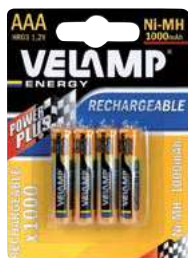

COD.	Type	Technology	Voltage (V)	Capacity (mAh)	Inner (pcs)	Master (pcs)
HR03/4BP	AAA/MINISTILO/HR03	Ni-Mh	1,2	1000	12	144

HR6-2600/2BP



COD.	Type	Technology	Voltage (V)	Capacity (mAh)	Inner (pcs)	Master (pcs)
HR6-2600/2BP	AA/STILO/HR6	Ni-Mh	1,2	2600	12	120



23719



COD.	Type	Technology	Dimensions (mm)	Inner (pcs)	Master (pcs)
23719	4V 4,5Ah	Lead acid	46 x 46 x 106	5	50



23720



COD.	Type	Technology	Dimensions (mm)	Inner (pcs)	Master (pcs)
23720	6V 1,3Ah	Lead acid	98 x 24 x 59	-	20

23729



COD.	Type	Technology	Dimensions (mm)	Inner (pcs)	Master (pcs)
23729	6V 2,8Ah	Lead acid	66 x 33 x 103	-	10

23725



COD.	Type	Technology	Dimensions (mm)	Inner (pcs)	Master (pcs)
23725	6V 3,2Ah	Lead acid	134 x 34 x 67	10	20

23722



COD.	Type	Technology	Dimensions (mm)	Inner (pcs)	Master (pcs)
23722	6V 4Ah	Lead acid	71 x 48 x 108	-	20

23726



COD.	Type	Technology	Dimensions (mm)	Inner (pcs)	Master (pcs)
23726	6V 7Ah	Lead acid	151 x 35 x 98	-	10

23723



COD.	Type	Technology	Dimensions (mm)	Inner (pcs)	Master (pcs)
23723	12V 1,3Ah	Lead acid	98 x 44 x 58	-	20

# BATTERIE AL PIOMBO RICARICABILI

Rechargeable lead acid batteries / Batteries au plomb rechargeables / Baterias recargables al plomo / Wiederaufladbare Bleibatterien



Home appliances & electric materials

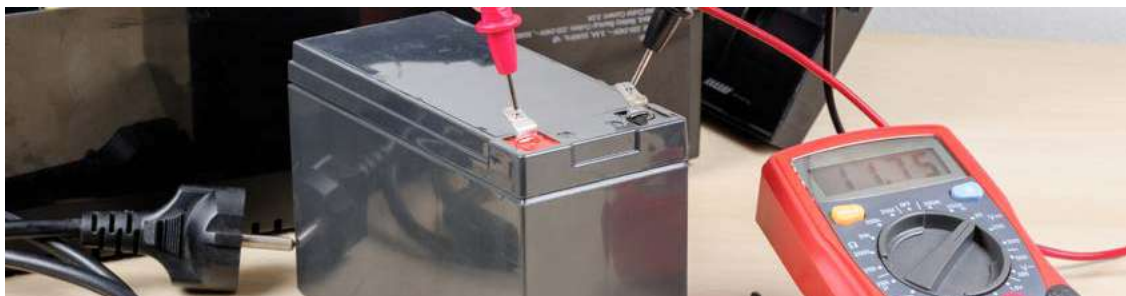

COD.	Type	Technology	Dimensions (mm)	Inner (pcs)	Master (pcs)
23724	12V 2,2 Ah	Lead acid	178 x 35 x 67	-	20



COD.	Type	Technology	Dimensions (mm)	Inner (pcs)	Master (pcs)
23728	12V 7Ah	Lead acid	150 x 165 x 100	-	10



COD.	Type	Technology	Dimensions (mm)	Inner (pcs)	Master (pcs)
23732	12V 9Ah	Lead acid	151 x 65 x 100	-	10



COD.	Type	Technology	Dimensions (mm)	Inner (pcs)	Master (pcs)
23731	12V 12 Ah	Lead acid	151 x 98 x 101	-	4



COD.	Type	Technology	Dimensions (mm)	Inner (pcs)	Master (pcs)
23735	12V 18Ah	Lead acid	180 x 77 x 168	-	2



COD.	Type	Technology	Dimensions (mm)	Inner (pcs)	Master (pcs)
23734	12V 26Ah	Lead acid	166 x 175 x 125	-	1

# Energizer®



NLR61



COD.	Type	Technology	Voltage (V)	Inner (pcs)	Master (pcs)
NLR61	LR61	Alkaline	9	-	12

NLR6X4



COD.	Type	Technology	Voltage (V)	Inner (pcs)	Master (pcs)
NLR6X4	AA/STILO/LR6	Alkaline	1,5	-	24

NLR6X5



COD.	Type	Technology	Voltage (V)	Inner (pcs)	Master (pcs)
NLR6X5	AA/STILO/LR6	Alkaline	1,5	-	24

NLR03X4



COD.	Type	Technology	Voltage (V)	Inner (pcs)	Master (pcs)
NLR03X4	AAA/MINISTILO/LR03	Alkaline	1,5	-	12

NLR03X5



COD.	Type	Technology	Voltage (V)	Inner (pcs)	Master (pcs)
NLR03X5	AAA/MINISTILO/LR03	Alkaline	1,5	-	24

NLR14



COD.	Type	Technology	Voltage (V)	Inner (pcs)	Master (pcs)
NLR14	C/MEZZATORCIA/LR14	Alkaline	1,5	-	12

NLR20



COD.	Type	Technology	Voltage (V)	Inner (pcs)	Master (pcs)
NLR20	D/TORCIA/LR20	Alkaline	1,5	6	12

NLR44X2



COD.	Type	Technology	Voltage (V)	Inner (pcs)	Master (pcs)
NLR44X2	LR44	Alkaline	1,5	10	100

NCR2032X2

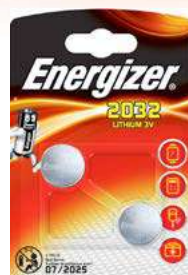

COD.	Type	Technology	Voltage (V)	Inner (pcs)	Master (pcs)
NCR2032X2	CR2032	Lithium	3	10	140

NCR2016X2

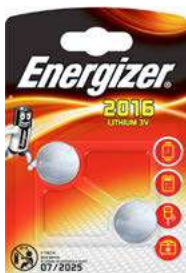

COD.	Type	Technology	Voltage (V)	Inner (pcs)	Master (pcs)
NCR2016X2	CR2016	Lithium	3	10	140

NCR2025X2

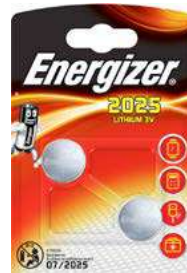

COD.	Type	Technology	Voltage (V)	Inner (pcs)	Master (pcs)
NCR2025X2	CR2025	Lithium	3	10	140



EXPO BANCO

8 facings

688251



ANTENNA DISPLAY















16 facings

688249



# GRADO DI PROTEZIONE IP

INDEX OF PROTECTION - GRADO DE PROTECCIÓN IP - INDICE DE PROTECTION

1 Cifra: protezione contro il contatto di corpi solidi 1st figure: protection against solid bodies 1er chiffre (dizaine): protection contre les solides. 1ª Cifra: Protección contra el contacto de cuerpos sólidos			2 Cifra: protezione dalla penetrazione di liquidi 2nd figure: protection against liquids 2º Cifra: Protección contra la penetración de líquidos. 2e chiffre (unité): protection contre l'intrusion d'eau.		
IP	TESTS		IP	TESTS	
0		Nessuna protezione No protection Aucune protection. Ninguna protección	0		Nessuna protezione No protection Aucune protection. Ninguna protección
1		Protezione contro corpi solidi di dimensioni superiori a 50 mm (dal contatto accidentale con le mani) Protected against solid bodies larger than 50 mm (eg.: accidental contact with the hand) Protégé contre les corps solides supérieurs à 50 mm Protección contra cuerpos sólidos de dimensiones superiores a 50 mm (por contacto accidental con las manos)	1		Protezione dalla caduta verticale di gocce d'acqua (condensa) Protected against vertically-falling drops of water (condensation) Protégé contre les chutes verticales de gouttes d'eau Protección de la caída vertical de gotas de agua (agua de condensación)
2		Protezione contro corpi solidi di dimensioni superiori a (dal contatto accidentale con le mani) 12,5 mm Protected against solid bodies larger than 12,5 mm (eg.: accidental contact with the hand) Protégé contre les corps solides supérieurs à 12,5 mm Protección contra cuerpos sólidos de dimensiones superiores a 12,5 mm (por contacto accidental con las manos)	2		Protezione dalla caduta di gocce d'acqua inclinazione max 15° Protected against drops of water falling at up to 15° from the vertical Protégé contre les chutes de gouttes d'eau jusqu'à 15° de la verticale Protección de la caída de gotas de agua, inclinación max 15°
3		Protezione contro corpi solidi di dimensioni superiori a 2,5 mm (utensili, cavi) Protected against solid bodies larger than 2,5 mm (tools, wires) Protégé contre les corps solides supérieurs à 2,5 mm Protección contra cuerpos sólidos de dimensiones superiores a 2,5 mm (útiles, cables)	3		Protezione dalla caduta di gocce d'acqua inclinazione max 60° Protected against drops of rainwater at up to 60° from the vertical Protégé contre l'eau en pluie jusqu'à 60° de la verticale Protección de la caída de gotas de agua, inclinación max 60°
4		Protezione contro corpi solidi di dimensioni superiori a 1 mm (piccoli utensili, cavi sottili) Protected against solid bodies larger than 1 mm (fine tools, small wires) Protégé contre les corps solides supérieurs à 1 mm Protección contra cuerpos sólidos de dimensiones superiores a 1 mm (pequeños utensilios, cables finos)	4		Protezione contro gli spruzzi d'acqua provenienti da tutte le direzioni Protected against projections of water from all directions Protégé contre les projections d'eau de toutes directions Protección contra las rociadas de agua desde de todas las direcciones
5		Protezione contro la polvere (no deposito dannoso) Protected against dust (no harmful deposit) Protégé contre les poussières et autres résidus microscopiques Protección contra los polvo (no depósito dañino)	5		Protezione contro getti d'acqua provenienti da tutte le direzioni Protected against jets of water from all directions Protégé contre les jets d'eau de toutes directions à la lance Protección contra chorros de agua desde todas las direcciones
6		Protezione completa dalla polvere Completely protected against dust Totalement protégé contre les poussières Protección completa contra los polvos.	6		Protezione contro ondate o getti d'acqua potenti Completely protected against jets of water or similar force to heavy seas. Protégé contre les forts jets d'eau de toutes directions à la lance Protección contra olas o poderosos chorros de agua.
			7		Protezione contro gli effetti dell'immersione Protected against the effects of immersion Protégé contre les effets de l'immersion temporaire (jusqu'à 1 m) et pendant 30 minutes. Protección contra los efectos de la inmersión
			8		Protezione contro gli effetti della prolungata immersione a condizioni particolari. Protected against effects of prolonged immersion under specified conditions Matériel submersible dans des conditions spécifiées en durée et en pression (immersion prolongée)4 au-delà de 1 m. Protección contra los efectos de inmersión prolongada en condiciones especiales

## LEGENDA SIMBOLI CONTENUTI NELLE TABELLE INFORMATIVE DEI PRODOTTI

Legend of symbols used in the catalogue - Légende des symboles utilisés - Símbolos de los caracteres contenido en los ficheros de los productos - Legende der verwendeten Symbole

	<b>Tecnologia della Luce</b> / Light technology / Technologie de la lumière / Tecnología de iluminación / Beleuchtungstechnologie
	<b>Lumen</b> / Lumen / Lumen / Lumen / Lumen
	<b>Portata</b> / Range / Distance d'éclairage / Alcance alumbrado / Reichweite
	<b>Autonomia</b> / Runtime / Autonomie / Autonomía / Autonomía / Autonomie
	<b>Fascio di luce</b> / Kind of beam / Type de faisceau / Tipo de haz / Tipo de haz / Ausstrahlungswinkel
	<b>Dimensioni prodotto</b> / Product dimensions / Dimensions/ Dimensiones producto/ Dimensiones producto / Abmessungen
	<b>Batteria</b> / Battery / Batterie / Batería / Batería / Batterie
	<b>Materiale</b> / Material / Matériau / Material / Material
	<b>Accessori inclusi</b> / Accessories included / Accessoires fourni / Accesorios incluidos / Mitgeliefertes Zubehör
<b>IP</b>	<b>Grado di protezione</b> / Protection degré / Degré de protection / Estandeidad / Schutzklasse
	<b>Alimentazione</b> / Power source / Alimentation / Alimentación / Stromversorgung
N/S	<b>Non significativo</b> / Not significant / Non significatif / No significativo / Nicht signifikant



# GRADO DI RESISTENZA MECCANICA

DEGREE OF PROTECTION AGAINST MECHANICAL WEAR & TEAR EN 62262 - GRADO DE RESISTENCIA MECÁNICA - INDICE DE RÉSISTANCE MÉCANIQUE

L'indicazione della resistenza meccanica IK è composta dalle lettere IK e il suo livello in una scala di undici gradi (da "00" a "10").

Più alto è il valore numerico del parametro IK, maggiore è la sua resistenza meccanica.

The Mechanical Protection ratings are defined by an IK rating, and IK ratings indicate how much impact energy an object can withstand. This energy is measured in joules, and the test is quite simply hitting the object with a known weight dropped from a known distance.

L'indice de résistance mécanique IK est composé des lettres IK et d'une échelle de 11 degrés (de «00» à «10»). Plus l'indice est élevé, meilleure est la résistance mécanique.

La indicación de la resistencia mecánica IK es compuesta por las letras IK y su nivel en una escala de once grados (de "00" a "10"). Cuanto mayor sea el valor numérico del parámetro IK, mayor será su resistencia mecánica.

Livello IK	Test	Equivalente dell'impatto h (cm) Mechanical Protection Weight x Swing	Resistenza all'impatto Impact energy (J)
00		Nessuna protezione - No protection - Aucune résistance - Ninguna protección	0 J
01		Equivalente dell'impatto di un oggetto di 0,25 kg da un'altezza di 56 mm Equivalent to impact of 0.25 kg mass dropped from 56 mm above impacted surface Équivalent à l'impact d'une masse de 0,25kg tombant d'une hauteur de 56mm. Equivalente al impacto de un objeto de 0,25 kg desde una altura de 56 mm.	Protetto contro l'impatto di 0,14 joules. Protected against 0,14 joules impact. Résistance à un impact de 0,14 joules Protegido contra el impacto de 0,14 joules
02		Equivalente dell'impatto di un oggetto di 0,25 kg da un'altezza di 80 mm. Equivalent to impact of 0.25 kg mass dropped from 80 mm above impacted surface Équivalent à l'impact d'une masse de 0,25kg tombant d'une hauteur de 80mm. Equivalente al impacto de un objeto de 0,25 kg desde una altura de 80 mm.	Protetto contro l'impatto di 0,2 joules. Protected against 0,2 joules impact. Résistance à un impact de 0,2 joules Protegido contra el impacto de 0,2 joules
03		Equivalente dell'impatto di un oggetto di 0,25 kg da un'altezza di 140 mm. Equivalent to impact of 0.25 kg mass dropped from 140 mm above impacted surface Équivalent à l'impact d'une masse de 0,25kg tombant d'une hauteur de 140mm. Equivalente al impacto de un objeto de 0,25 kg desde una altura de 140 mm	Protetto contro l'impatto di 0,35 joules. Protected against 0,35 joules impact. Résistance à un impact de 0,35 joules Protegido contra el impacto de 0,35 joules
04		Equivalente dell'impatto di un oggetto di 0,25 kg da un'altezza di 200 mm. Equivalent to impact of 0.25 kg mass dropped from 200 mm above impacted surface Équivalent à l'impact d'une masse de 0,25kg tombant d'une hauteur de 200mm. Equivalente al impacto de un objeto de 0,25 kg desde una altura de 200 mm	Protetto contro l'impatto di 0,50 joules. Protected against 0,50 joules impact. Résistance à un impact de 0,5 joules Protegido contra el impacto de 0,50 joules
05		Equivalente dell'impatto di un oggetto di 0,25 kg da un'altezza di 280 mm. Equivalent to impact of 0.25 kg mass dropped from 280 mm above impacted surface Équivalent à l'impact d'une masse de 0,25kg tombant d'une hauteur de 280mm. Equivalente al impacto de un objeto de 0,25 kg desde una altura de 280 mm	Protetto contro l'impatto di 0,70 joules. Protected against 0,70 joules impact. Résistance à un impact de 0,7 joules Protegido contra el impacto de 0,70 joules
06		Equivalente dell'impatto di un oggetto di 0,25 kg da un'altezza di 400 mm. Equivalent to impact of 0.25 kg mass dropped from 400 mm above impacted surface. Équivalent à l'impact d'une masse de 0,25kg tombant d'une hauteur de 400mm. Equivalente al impacto de un objeto de 0,25 kg desde una altura de 400 mm.	Protetto contro l'impatto di 1 joules. Protected against 1 joules impact. Résistance à un impact de 1 joule Protegido contra el impacto de 1 joule.
07		Equivalente dell'impatto di un oggetto di 0,5 kg da un'altezza di 400 mm. Equivalent to impact of 0.5 kg mass dropped from 400 mm above impacted surface Équivalent à l'impact d'une masse de 0,5kg tombant d'une hauteur de 400mm. Equivalente al impacto de un objeto de 0,5 kg desde una altura de 400 mm.	Protetto contro l'impatto di 2 joules. Protected against 2 joules impact. Résistance à un impact de 2 joules Protegido contra el impacto de 2 joules.
08		Equivalente dell'impatto di un oggetto di 1,7 kg da un'altezza di 300 mm. Equivalent to impact of 1,7 kg mass dropped from 300 mm above impacted surface Équivalent à l'impact de un objeto de 1,7 kg desde una altura de 300mm. Équivalent à l'impact d'une masse de 1,7kg tombant d'une hauteur de 300mm.	Protetto contro l'impatto di 5 joules. Protected against 5 joules impact. Résistance à un impact de 5 joules Protegido contra el impacto de 5 joules.
09		Equivalente dell'impatto di un oggetto di 5 kg da un'altezza di 200 mm. Equivalent to impact of 5 kg mass dropped from 200 mm above impacted surface Équivalent à l'impact d'une masse de 5kg tombant d'une hauteur de 200mm. Equivalente al impacto de un objeto de 5 kg desde una altura de 200 mm	Protetto contro l'impatto di 10 joules. Protected against 10 joules impact. Résistance à un impact de 10 joules Protegido contra el impacto de 10 joules
10		Equivalente dell'impatto di un oggetto di 5 kg da un'altezza di 400 mm. Equivalent to impact of 5 kg mass dropped from 40 mm above impacted surface Équivalent à l'impact d'une masse de 5kg tombant d'une hauteur de 400mm. Equivalente al impacto de un objeto de 5 kg desde una altura de 400 mm	Protetto contro l'impatto di 20 joules. Protected against 20 joules impact. Résistance à un impact de 20 joules Protegido contra el impacto de 20 joules.

Codice articolo	EAN	Imballo	Inner	Master	Peso Kg	Pag.
8003910923225	20999	White Box	1	50	0,200	23
8003910902206	23719	Bulk	5	50	0,440	250
8003910006799	23720	Bulk	20	20	0,270	250
8003910900172	23722	Bulk	20	20	0,660	250
8003910006805	23723	Bulk	20	20	0,500	250
8003910006812	23724	Bulk	20	20	0,850	251
8003910107427	23725	Bulk	10	20	0,614	250
8003910001046	23726	Bulk	10	10	1,111	250
8003910006829	23728	Bulk	10	10	1,850	251
8003910108059	23729	Bulk	10	10	0,504	250
8003910104563	23731	Bulk	4	4	3,538	251
8003910108288	23732	Bulk	10	10	2,473	251
8003910108295	23734	Bulk	1	1	8,080	251
8003910104556	23735	Bulk	2	2	5,000	251
7638900882490	688249	Bulk	1	1	0,000	253
7638900882513	688251	Bulk	1	1	0,000	253
8003910105621	23717.R	Bulk	50	500	0,052	247
8003910900561	3R12/1BP	Blister 1 pce	10	120	0,080	244
8003910900615	4R25/1B	Bulk	24	24	0,480	244
8003910900059	6LR61/1BP	Blister 1 pce	12	144	0,047	246
8003910904323	ADAPT-3-10A	Bulk	25	200	0,040	209
8003910904347	ADAPT-3-10S	Bulk	25	200	0,006	209
8003910904330	ADAPT-3-16A	Bulk	25	200	0,040	209
8003910904354	ADAPT-3-16S	Bulk	25	200	0,058	209
8003910904309	ADAPT-IT-10S	Bulk	25	200	0,039	209
8003910904316	ADAPT-IT-16S	Bulk	25	200	0,035	209
8003910102033	ADAT-FR-1	Bulk	10	100	0,065	218
8003910102040	ADAT-FR-2	Bulk	10	100	0,060	218
8003910102057	ADAT-FR-3	Bulk	10	100	0,355	218
8003910109506	ADAT-FR-4	Bulk	10	100	0,000	218
8003910107618	B23716	Blister	12	192	0,050	247
8003910107755	BATT3744	Bulk	5	50	0,092	248
8003910107762	BATT7480	Bulk	5	50	0,362	248
8003910105638	BATTIR666	Bulk	5	50	0,048	247
8003910102552	BATTIR867	Bulk	5	50	0,180	247
8003910102798	BIGBOB-B	Colour box	8	8	1,100	52
8003910101845	BUBBLE-B	Bulk	12	24	1,000	53
8003910101852	BUBBLE-N	Bulk	12	24	1,200	53
8003910104839	CAPO1	Plastic hanger	6	48	0,111	32
8003910104846	CAPO2	Plastic hanger	6	48	0,111	32
8003910110007	CAPO2L	Plastic hanger	6	48	0,109	32
8003910104853	CAPO3	Plastic hanger	6	48	0,111	33
8003910109902	CAPO3PILE	Plastic hanger	6	48	0,107	33
8003910106475	CAPO4	Plastic hanger	6	48	0,111	33
8003910106482	CAPO5	Plastic hanger	6	48	0,111	34
8003910106499	CAPO6	Plastic hanger	6	48	0,111	34
8003910106505	CAPO7	Plastic hanger	6	48	0,111	35
8003910110014	CAPO7L	Plastic hanger	6	48	0,106	35
8003910107465	CAPO8	Plastic hanger	6	48	0,108	35
8003910107441	CAPO9	Plastic hanger	6	48	0,108	35
8003910107458	CAP10	Plastic hanger	6	48	0,108	36
8003910109964	CAP103	Plastic hanger	6	48	0,000	40
8003910109971	CAP104	Plastic hanger	6	48	0,000	40
8003910109988	CAP106	Plastic hanger	6	48	0,000	40
8003910107472	CAP11	Plastic hanger	6	48	0,108	36
8003910107489	CAP12	Plastic hanger	6	48	0,108	36
8003910109896	CAP14	Plastic hanger	6	48	0,111	36
8003910107496	CAP15	Plastic hanger	6	48	0,108	37

Codice articolo	EAN	Imballo	Inner	Master	Peso Kg	Pag.
8003910107502	CAP16	Plastic hanger	6	48	0,108	37
8003910107519	CAP17	Plastic hanger	6	48	0,108	37
8003910107526	CAP18	Plastic hanger	6	48	0,108	37
8003910107601	CAP19	Plastic hanger	6	48	0,108	38
8003910109926	CAP23	Plastic hanger	6	48	0,111	38
8003910109933	CAP83	Plastic hanger	6	48	0,000	39
8003910109940	CAP85	Plastic hanger	6	48	0,000	39
8003910109957	CAP90	Plastic hanger	6	48	0,000	39
8003910110021	CAPLED	Polybag	1	500	0,020	38
8003910107878	CBT06	Colour Box	6	24	0,074	247
8003910003996	CCTV01	Bulk	10	80	0,140	203
8003910007239	CF001	Blister	12	288	0,020	224
8003910007246	CF002	Blister	12	288	0,033	224
8003910107861	CIP607	Shrink	10	50	0,120	229
8003910102231	CIP681	Polybag	12	192	0,400	229
8003910102248	CIP682	Polybag	12	96	0,060	229
8003910108097	COOLER34	Colour Box	1	1	4,895	193
8003910900851	CR2016	Blister	50	1000	0,004	249
8003910900868	CR2025	Blister	50	1000	0,017	249
8003910900875	CR2032	Blister	50	1000	0,017	249
8003910102835	CR24X	Blister	25	100	0,060	249
8003910102569	D64	Blister	12	48	0,135	173
8003910107342	D83	Display 12 pces	12	48	0,094	239
8003910902237	D85	Display 12 pces	12	96	0,087	235
8003910109797	D86	Display 12 pces	12	48	0,000	235
8003910105256	D89	Display 12 pces	12	96	0,046	236
8003910006669	DL101	Display 12 pces	12	96	0,065	232
8003910106888	DL104	Display 12 pces	12	96	0,082	232
8003910107335	DL202	Display 12 pces	12	96	0,045	234
8003910923393	DMT600	Blister	6	60	0,164	237
8003910923386	DMT700	Blister	6	60	0,207	237
8003910009806	DOM001	Blister	6	48	0,170	202
8003910109773	DOM008	Blister	6	48	0,175	202
8003910902626	DOMREEL-10	Bulk	10	10	1,265	221
8003910107847	DOMREEL-10-IT	Bulk	10	10	1,207	215
8003910107854	DOMREEL-5-IT	Bulk	10	10	0,720	215
8003910104433	ECOPOWER218	Colour Box	12	12	0,680	42
8003910104440	ECOPOWER236	Colour Box	12	12	1,260	42
8003910104457	ECOPOWER258	Colour Box	12	12	1,445	42
8003910109537	ER116	Colour Box	6	24	0,170	157
8003910107281	ER122	Colour Box	6	24	0,416	158
8003910109520	ER127	Colour Box	6	24	0,648	159
8003910900714	HR03/4BP	Blister	12	144	0,052	249
8003910900707	HR6-2600/2BP	Blister	12	120	0,060	249
8003910105225	IC207	Display 12 pces	12	48	0,122	238
8003910101661	ID72LED	Polybag	12	72	0,200	173
8003910902923	IF06B	Blister	12	48	0,400	8
8003910006065	IHS10.DL	Blister	6	48	0,300	11
8003910902220	IHS22	Blister	6	72	0,080	11
8003910106086	IHS523	Blister	6	48	0,138	12
8003910102644	IHS35	Blister	6	36	0,220	12
8003910200784	IL01	Colour Box	12	48	0,120	239
8003910109704	IL013-R	Bulk	20	20		241
8003910109711	IL016	Bulk	6	18	0,060	242
8003910109698	IL017	Bulk	8	8	0,273	242
8003910109674	IL018-R	Bulk	30	30	0,086	241
8003910109667	IL019-B	Bulk	30	30	0,102	240
8003910109650	IL019-R	Bulk	30	30	0,102	240

# INDICE ALFABETICO PRODOTTI

Alphabetical index product

Codice articolo	EAN	Imballo	Inner	Master	Peso Kg	Pag.
8003910100138	IL04	B blister	12	120	0,040	165
8003910116627	IL05LED	B blister	12	72	0,200	172
8003910901384	IL09LED	B blister	12	120	0,040	165
8003910105263	IL11EVO2	B blister	6	48	0,080	168
8003910120082	IL12	B blister	12	120	0,100	172
8003910003828	IL24WS	B blister	12	48	0,120	170
8003910004023	IL27	B blister	12	120	0,053	167
8003910107595	IL28	B blister	12	120	0,050	167
8003910110274	IL29	B blister	12	120	0,000	166
8003910110281	IL30	B blister	12	120	0,000	166
8003910105034	IL84-B	B blister	12	48	0,080	171
8003910105027	IL84-R	B blister	12	48	0,080	171
8003910902039	IM421	B blister	6	72	0,120	8
8003910107953	IN221	Display 12 pces	12	48	0,024	237
8003910902817	IN229	Display 24 pces	24	192	0,015	238
8003910902565	IN232	B blister	12	72	0,048	155
8003910007499	IN238	Display 20 pces	12	48	0,020	234
8003910007369	IN239	Display 12 pces	12	48	0,025	237
8003910310254	IN240	B blister	6	48	0,100	8
8003910904583	IN247	B blister	6	48	0,150	9
8003910102811	IN256	Display 12 pces	12	48	0,130	236
8003910106826	IN283	Display 20 pces	20	240	0,036	155
8003910110441	IN286	Colour Box	12	48		154
8003910923300	IN287	Display 12 pces	12	48	0,146	154
8003910109780	IN288	Display 12 pces	12	48	0,000	154
8003910100091	IN292	Display 12 pces	12	72	0,050	183
8003910100114	IN294	Display 12 pces	12	72	0,052	183
8003910108370	IN322	Display 12 pces	12	48	0,071	253
8003910923195	IPO5	B blister	6	24	0,131	174
8003910923201	IPO6	B blister	6	24	0,253	174
8003910100336	IR160EVO	Colour Box	6	6	0,670	160
8003910106031	IR162	Colour Box	6	24	0,480	163
8003910106048	IR163	Colour Box	6	24	0,680	163
8003910102583	IR170EVO	Colour Box	6	24	0,500	161
8003910108387	IR236	B blister	6	48	0,000	156
8003910106024	IR312	Colour Box	6	24	0,625	162
8003910106642	IR439	B blister	6	48	0,216	14
8003910104860	IR471	B blister	6	48	0,180	13
8003910104419	IR547	Colour Box	6	24	0,374	9
8003910009110	IR551LED	Colour Box	6	24	0,495	18
8003910003576	IR554LED	Colour Box	6	24	0,524	18
8003910100299	IR558	Colour Box	6	24	0,512	19
8003910107731	IR561	Colour Box	6	12	0,840	19
8003910110427	IR578	B blister	6	24		15
8003910003897	IR666-10W	Colour Box	6	18	1,000	23
8003910003880	IR666-5W	Colour Box	6	18	0,950	22
8003910003873	IR666-DRY	Bulk	6	18	0,700	17
8003910105560	IR827	Colour Box	4	24	0,623	23
8003910100244	IR867	Colour Box	4	4	1,700	25
8003910107304	IR882	Colour Box	6	18	0,930	22
8003910115019	IRUB1LED	B blister	12	72	0,150	7
8003910118034	IRUB20LED	Bulk	6	24	0,512	17
8003910115026	IRUB2LED	B blister	12	48	0,500	7
8003910115033	IRUB3LED	B blister	12	48	0,600	7
8003910101944	IS314	B blister	6	48	0,060	6
8003910107410	IS342	Colour Box	4	4	1,060	99
8003910902701	IS352	Colour Box	6	6	0,485	98
8003910007383	IS404	B blister	6	48	0,220	13

Codice articolo	EAN	Imballo	Inner	Master	Peso Kg	Pag.
8003910108363	IS419	B blister	6	48	0,118	10
8003910105232	IS463	Display 12 pces	12	72	0,084	233
8003910004061	IS475	B blister	6	24	0,520	14
8003910902190	IS525	Polybag	12	24	0,800	16
8003910902718	IS529	Polybag	12	24	1,100	16
8003910923188	IS540	Polybag	12	24	0,420	16
8003910003651	IS575	B blister	6	24	0,460	15
8003910105669	IS590	B blister	6	24	0,737	24
8003910107779	IS701	Colour Box	6	12	0,727	59
8003910107786	IS702	Colour Box	6	12	0,789	60
8003910107793	IS703	Colour Box	6	12	0,824	61
8003910105577	IS720	Shrink	6	18	0,680	62
8003910107359	IS726	Colour Box	6	24	0,650	66
8003910109810	IS727	Colour Box	4	16		64
8003910108226	IS728	Colour Box	4	12	0,344	63
8003910108219	IS730	Colour Box	4	12	0,454	67
8003910106918	IS740-5-4000K	Colour Box	10	40	0,225	68
8003910106987	IS740-5-6500K	Colour Box	10	40	0,225	70
8003910106956	IS743-5-4000K	Colour Box	6	30	0,260	69
8003910107021	IS743-5-6500K	Colour Box	6	30	0,260	71
8003910105119	IS744	Colour Box	6	24	0,566	73
8003910106925	IS745-5-4000K	Colour Box	10	40	0,300	68
8003910106994	IS745-5-6500K	Colour Box	10	40	0,300	70
8003910107298	IS746-50W	Colour Box	2	2	4,150	30
8003910105317	IS747-3	Colour Box	4	4	4,100	29
8003910106963	IS748-5-4000K	Colour Box	6	24	0,398	69
8003910107038	IS748-5-6500K	Colour Box	6	24	0,398	71
8003910904446	IS749-2	Colour Box	4	4	3,370	28
8003910105010	IS750-3	Colour Box	8	8	1,056	26
8003910106932	IS755-5-4000K	Colour Box	8	32	0,454	68
8003910107007	IS755-5-6500K	Colour Box	8	32	0,448	70
8003910106949	IS760-5-4000K	Colour Box	8	16	0,939	68
8003910107014	IS760-5-6500K	Colour Box	8	16	0,918	70
8003910106635	IS766	Colour Box	4	4	2,350	27
8003910106970	IS768-5-4000K	Colour Box	4	16	1,024	69
8003910107045	IS768-5-6500K	Colour Box	4	16	0,731	71
8003910104570	IS781	Colour Box	4	4	1,270	72
8003910104587	IS783	Colour Box	2	2	3,860	72
8003910104594	IS786	Colour Box	2	2	4,960	72
8003910108431	LANSEF-305	Pull Box	2	2	7,480	230
8003910108400	LANSEU-100	Shrink	4	4	1,840	230
8003910108394	LANSEU-305	Pull Box	2	2	6,300	230
8003910108448	LAN6F-305	Pull Box	2	2	9,300	231
8003910108424	LAN6U-100	Shrink	4	4	2,600	231
8003910108417	LAN6U-305	Pull Box	2	2	8,440	231
8003910108462	LANC5F-100	Polybag	25	25	0,225	230
8003910108455	LANC5U-100	Polybag	25	25	0,153	230
8003910108486	LANC6F-100	Polybag	25	25	0,224	231
8003910108479	LANC6U-100	Polybag	25	25	0,148	231
8003910108905	LB106-30K	Colour Box	10	200	0,035	119
8003910108912	LB106-40K	Colour Box	10	200	0,035	119
8003910110069	LB106-65K	Colour Box	10	200	0,035	119
8003910108929	LB108-30K	Colour Box	10	200	0,035	119
8003910108936	LB108-40K	Colour Box	10	200	0,035	119
8003910110076	LB108-65K	Colour Box	10	200	0,035	119
8003910108943	LB156-30K	Colour Box	10	200	0,035	119
8003910108950	LB156-40K	Colour Box	10	200	0,035	119
8003910108967	LB158-30K	Colour Box	10	200	0,035	119

Codice articolo	EAN	Imballo	Inner	Master	Peso Kg	Pag.
8003910108974	LB158-40K	Colour Box	10	200	0,035	119
8003910108981	LB207C-27K	Colour Box	10	100	0,042	120
8003910108998	LB207C-40K	Colour Box	10	100	0,042	120
8003910109001	LB207M-30K	Colour Box	10	100	0,042	122
8003910109018	LB207M-40K	Colour Box	10	100	0,042	122
8003910109025	LB207M-65K	Colour Box	10	100	0,042	122
8003910109032	LB208C-27K	Colour Box	10	100	0,042	120
8003910109049	LB208C-40K	Colour Box	10	100	0,042	120
8003910109056	LB208M-30K	Colour Box	10	100	0,042	122
8003910109063	LB208M-40K	Colour Box	10	100	0,042	122
8003910109070	LB208M-65K	Colour Box	10	100	0,042	122
8003910108615	LB209S-30K	Colour Box	10	100	0,040	116
8003910108622	LB209S-40K	Colour Box	10	100	0,040	116
8003910108639	LB209S-65K	Colour Box	10	100	0,040	116
8003910108738	LB209SF-30K	Colour Box	10	100	0,040	117
8003910108745	LB209SF-40K	Colour Box	10	100	0,040	117
8003910109087	LB212C-27K	Colour Box	10	100	0,042	120
8003910109094	LB212C-40K	Colour Box	10	100	0,042	120
8003910109100	LB212M-30K	Colour Box	10	100	0,042	122
8003910109117	LB212M-40K	Colour Box	10	100	0,042	122
8003910109124	LB212M-65K	Colour Box	10	100	0,042	122
8003910108646	LB212S-30K	Colour Box	10	100	0,040	116
8003910108653	LB212S-40K	Colour Box	10	100	0,040	116
8003910108660	LB212S-65K	Colour Box	10	100	0,040	116
8003910108752	LB212SF-30K	Colour Box	10	100	0,040	117
8003910108769	LB212SF-40K	Colour Box	10	100	0,040	117
8003910108677	LB215S-30K	Colour Box	10	100	0,053	116
8003910108684	LB215S-40K	Colour Box	10	100	0,053	116
8003910108691	LB215S-65K	Colour Box	10	100	0,053	116
8003910108776	LB215SF-30K	Colour Box	10	100	0,054	117
8003910108783	LB215SF-40K	Colour Box	10	100	0,054	117
8003910108707	LB220S-30K	Colour Box	10	100	0,095	116
8003910108714	LB220S-40K	Colour Box	10	100	0,095	116
8003910108721	LB220S-65K	Colour Box	10	100	0,095	116
8003910109131	LB304C-27K	Colour Box	10	100	0,021	121
8003910109148	LB304C-40K	Colour Box	10	100	0,021	121
8003910109179	LB304M-30K	Colour Box	10	100	0,021	123
8003910109186	LB304M-40K	Colour Box	10	100	0,021	123
8003910109193	LB304M-65K	Colour Box	10	100	0,021	123
8003910109155	LB306C-27K	Colour Box	10	100	0,021	121
8003910109162	LB306C-40K	Colour Box	10	100	0,021	121
8003910109209	LB306M-30K	Colour Box	10	100	0,021	123
8003910109216	LB306M-40K	Colour Box	10	100	0,021	123
8003910109223	LB306M-65K	Colour Box	10	100	0,021	123
8003910108790	LB306S-30K	Colour Box	10	100	0,023	118
8003910108806	LB306S-40K	Colour Box	10	100	0,023	118
8003910108813	LB306S-65K	Colour Box	10	100	0,023	118
8003910109254	LB4047C-27K	Colour Box	10	100	0,024	120
8003910109261	LB4047C-40K	Colour Box	10	100	0,024	120
8003910109346	LB4047M-30K	Colour Box	10	100	0,024	122
8003910109353	LB4047M-40K	Colour Box	10	100	0,024	122
8003910109360	LB4047M-65K	Colour Box	10	100	0,024	122
8003910109230	LB404C-27K	Colour Box	10	100	0,021	120
8003910109247	LB404C-40K	Colour Box	10	100	0,021	120
8003910109315	LB404M-30K	Colour Box	10	100	0,021	123
8003910109322	LB404M-40K	Colour Box	10	100	0,021	123
8003910109339	LB404M-65K	Colour Box	10	100	0,021	123
8003910109292	LB4067C-27K	Colour Box	10	100	0,024	120

Codice articolo	EAN	Imballo	Inner	Master	Peso Kg	Pag.
8003910109308	LB4067C-40K	Colour Box	10	100	0,024	120
8003910109407	LB4067M-30K	Colour Box	10	100	0,024	122
8003910109414	LB4067M-40K	Colour Box	10	100	0,024	122
8003910109421	LB4067M-65K	Colour Box	10	100	0,024	122
8003910108851	LB4067S-30K	Colour Box	10	100	0,023	116
8003910108868	LB4067S-40K	Colour Box	10	100	0,023	116
8003910108875	LB4067S-65K	Colour Box	10	100	0,023	116
8003910109278	LB406C-27K	Colour Box	10	100	0,021	121
8003910109285	LB406C-40K	Colour Box	10	100	0,021	121
8003910109377	LB406M-30K	Colour Box	10	100	0,021	123
8003910109384	LB406M-40K	Colour Box	10	100	0,021	123
8003910109391	LB406M-65K	Colour Box	10	100	0,021	123
8003910108820	LB406S-30K	Colour Box	10	100	0,023	118
8003910108837	LB406S-40K	Colour Box	10	100	0,023	118
8003910108844	LB406S-65K	Colour Box	10	100	0,023	118
8003910108882	LB406SF-30K	Colour Box	10	100	0,023	117
8003910108899	LB406SF-40K	Colour Box	10	100	0,023	117
8003910109438	LB512M-30K	Colour Box	10	40	0,120	122
8003910109445	LB512M-40K	Colour Box	10	40	0,120	122
8003910109452	LB512M-65K	Colour Box	10	40	0,120	122
8003910109469	LB518M-30K	Colour Box	10	40	0,120	122
8003910109476	LB518M-40K	Colour Box	10	40	0,120	122
8003910109483	LB518M-65K	Colour Box	10	40	0,120	122
8003910109759	LB901F-30K	Blister	10	80	0,023	124
8003910109742	LB9030-27K	Blister	10	80	0,014	124
8003910109612	LB993-30K	Blister	10	100	0,020	125
8003910109629	LB993-40K	Blister	10	100	0,020	125
8003910109636	LB994-30K	Blister	10	100	0,023	125
8003910109643	LB994-40K	Blister	10	100	0,023	125
8003910102200	LC350	Shrink	6	24	0,140	10
8003910350076	LE004LED	Colour Box	4	4	1,485	150
8003910107809	LE008	Colour Box	6	24	0,430	151
8003910107816	LE035	Colour Box	6	48	0,320	152
8003910107823	LE037	Colour Box	6	48	0,164	153
8003910902893	LHGU10	Bulk	50	1000	0,020	229
8003910900097	LR03/12PACK	Shrink	6	96		245
8003910110304	LR03/24BOX	Colour Box	6	48	0,000	246
8003910900011	LR03/4BP	Blister 4 pces	12	144	0,045	245
8003910105348	LR03/8BP	Blister 8 pces	10	120	0,100	245
8003910900035	LR14/2BP	Blister 2 pces	12	72	0,160	246
8003910900042	LR20/2BP	Blister 2 pces	10	60	0,280	246
8003910900066	LR23A	Blister 1 pce	12	144	0,050	246
8003910900080	LR6/12PACK	Shrink	6	48	0,280	245
8003910110311	LR6/24BOX	Colour Box	6	36	0,000	246
8003910900028	LR6/4BP	Blister 4 pces	12	144	0,100	245
8003910105355	LR6/8BP	Blister 8 pces	10	60	0,185	245
8003910923171	LT011	Blister	6	48	0,094	168
8003910109766	LT012	Blister	4	24	0,000	169
8003910105218	LT018	Blister	6	48	0,083	170
8003910101173	MG101	Polybag	10	500	0,031	226
8003910101180	MG102	Polybag	10	350	0,045	226
8003910101197	MG103	Polybag	10	300	0,055	226
8003910101210	MG111	Polybag	10	200	0,900	226
8003910101227	MG112	Polybag	10	160	0,142	226
8003910101274	MG113	Polybag	10	200	0,080	226
8003910101234	MG120	Polybag	10	140	0,120	226
8003910101241	MG121	Polybag	10	100	0,200	226
8003910101258	MG122	Polybag	10	90	0,240	226

# INDICE ALFABETICO PRODOTTI

Alphabetical index product

Codice articolo	EAN	Imballo	Inner	Master	Peso Kg	Pag.
8003910101265	MG130	Polybag	5	50	0,200	226
8003910101289	MG140	Polybag	5	200	0,010	226
8003910101319	MG199	Polybag	5	200	0,105	226
8003910101074	MG201	Polybag	10	500	0,035	227
8003910101081	MG202	Polybag	10	350	0,044	227
8003910101098	MG203	Polybag	10	300	0,057	227
8003910101111	MG211	Polybag	10	200	0,090	227
8003910101128	MG212	Polybag	10	160	0,013	227
8003910101135	MG220	Polybag	10	140	0,130	227
8003910101142	MG221	Polybag	10	100	0,200	227
8003910101159	MG222	Polybag	10	90	0,232	227
8003910101166	MG230	Polybag	5	50	0,380	227
8003910101205	MG271	Polybag	10	140	0,100	227
8003910101212	MG272	Polybag	10	500	0,030	227
8003910101199	MG280	Polybag	10	40	0,230	227
8003910101708	MG303	Shrink	100	1000	0,015	225
8003910101715	MG306	Shrink	100	1000	0,020	225
8003910101722	MG310	Shrink	100	800	0,035	225
8003910101739	MG330	Shrink	100	400	0,070	225
8003910101364	MG360	Shrink	100	200	0,095	225
8003910106864	MINICOOL	Colour Box	4	32	0,600	192
8003910107120	MINICOOL-PAD	Polybag	12	50	0,028	192
8003910107137	MK040	Colour Box	6	60	0,164	195
8003910107144	MK040H	Colour Box	6	60	0,164	195
8003910107151	MK170	Colour Box	6	24	0,573	197
8003910108080	MK174E	Colour Box	6	6	1,130	198
8003910107977	MK180	Colour Box	6	6	0,917	196
8003910107960	MK312	Colour Box	6	6	1,302	199
8003910107168	MK320	Colour Box	6	6	1,812	200
8003910107175	MK340	Colour Box	4	4	2,756	201
8003910006348	MS002	Blister	6	36	0,181	204
8003910104488	MS005	Blister	6	36	0,180	204
8003910104426	MS007	Blister	6	36	0,140	205
8003910902985	MS012	Blister	6	36	0,160	205
8003910101982	MULTIP-FR-3	Plastic hanger	10	50	0,208	219
8003910003439	MULTIP-FR-4	Plastic hanger	10	50	0,240	219
8003910003446	MULTIP-FR-5	Plastic hanger	10	40	0,254	219
8003910101999	MULTIP-FR-1-3	Plastic hanger	10	50	0,220	219
8003910003453	MULTIP-FR-1-4	Plastic hanger	10	50	0,247	219
8003910003460	MULTIP-FR-1-5	Plastic hanger	10	40	0,260	219
8003910108325	MULTIP-FR-USB3	Plastic hanger	5	40	0,306	220
8003910108332	MULTIP-FR-USB5	Plastic hanger	5	40	0,352	220
8003910923003	MULTIT-I-102	Plastic hanger	5	30	0,224	210
8003910923034	MULTIT-I-S24	Plastic hanger	5	25	0,292	210
8003910108554	MULTIT-I-S24K	Plastic hanger	5	25	0,293	210
8003910904019	MULTIT-I-S30	Plastic hanger	5	25	0,260	211
8003910108165	MULTIT-I-S30K	Plastic hanger	5	25	0,260	211
8003910923041	MULTIT-I-S36	Plastic hanger	5	25	0,341	210
8003910108530	MULTIT-I-S36K	Plastic hanger	5	25	0,336	210
8003910904026	MULTIT-I-S40	Plastic hanger	5	25	0,280	211
8003910108172	MULTIT-I-S40K	Plastic hanger	5	25	0,280	211
8003910904033	MULTIT-I-S50	Plastic hanger	5	25	0,337	212
8003910108189	MULTIT-I-S50K	Plastic hanger	5	25	0,308	212
8003910904040	MULTIT-I-S60	Plastic hanger	5	25	0,345	212
8003910108196	MULTIT-I-S60K	Plastic hanger	5	25	0,345	212
80039101010298	MULTIT-I-S66	Plastic hanger	5	30	0,000	212
7638900248340	NCR2016X2	Blister	10	140	0,011	253
7638900248333	NCR2025X2	Blister	10	140	0,011	253

Codice articolo	EAN	Imballo	Inner	Master	Peso Kg	Pag.
7638900248357	NCR2032X2	Blister	10	140	0,011	253
8003910101548	NEPF118	Colour Box	12	12	0,450	46
8003910101562	NEPF136	Colour Box	12	12	0,730	46
8003910101586	NEPF158	Colour Box	12	12	0,900	46
8003910101555	NEPF218	Colour Box	8	8	0,620	46
8003910101579	NEPF236	Colour Box	8	8	1,000	46
8003910101593	NEPF258	Colour Box	8	8	1,210	46
7638900247893	NLR03X4	Blister	12	12	0,055	252
7638900414981	NLR03X5	Blister	24	24	0,063	252
7638900297324	NLR14	Blister	12	12	0,148	252
7638900297331	NLR20	Blister	6	12	0,288	252
7638900083071	NLR44X2	Blister	10	100		253
7638900297409	NLR61	Blister	12	12	0,055	252
7638900246599	NLR6X4	Blister	24	24	0,098	252
7638900414974	NLR6X5	Blister	24	24	0,115	252
8003910902879	PALPEBRA-B	Shrink	12	48	0,260	55
8003910902862	PALPEBRA-N	Shrink	12	48	0,323	55
8003910107373	PANLEDO5-3000K	White Box	5	5	2,040	130
8003910107366	PANLEDO5-4000K	White Box	5	5	2,040	130
8003910107380	PANUGR-4000K	White Box	5	5	2,250	131
8003910902374	PENLEDO5	Blister	12	96	0,040	6
8003910100633	PI20258	Shrink	8	8	0,885	129
8003910904248	PLUG-IT-10A	Bulk	25	500	0,018	208
8003910904262	PLUG-IT-10AK	Bulk	25	500	0,022	208
8003910904286	PLUG-IT-10F	Bulk	25	500	0,030	208
8003910904255	PLUG-IT-16A	Bulk	25	500	0,030	208
8003910904279	PLUG-IT-16AK	Bulk	25	500	0,028	208
8003910904293	PLUG-IT-16F	Bulk	25	500	0,036	208
8003910106123	PRO10-2	Colour Box	8	8	1,100	176
8003910106130	PRO12-2	Colour Box	6	6	1,500	177
8003910105683	PRO14	Colour Box	6	30	0,540	178
8003910107625	PR152	Colour Box	10	10	0,887	179
8003910107632	PR162	Colour Box	1	1	2,330	181
8003910107649	PR170	Colour Box	10	10		180
8003910107656	PR206T	Colour Box	1	1	3,026	182
8003910102002	PRO10A-FR-2	Plastic hanger	10	80	0,140	221
8003910102019	PRO10A-FR-5	Plastic hanger	10	50	0,244	221
8003910003507	PRO16A-FR-10	Plastic hanger	5	10	1,160	220
8003910003484	PRO16A-FR-3	Plastic hanger	5	20	0,420	220
8003910003491	PRO16A-FR-5	Plastic hanger	5	20	0,620	220
8003910101494	PRO715-10F	Plastic hanger	6	6	1,000	221
8003910904217	PROHD16A-FR-20	Plastic hanger	6	6	2,050	217
8003910923058	PROLIT10A-3	Plastic hanger	5	30	0,280	213
8003910108127	PROLIT10A-3K	Plastic hanger	5	30	0,285	213
8003910923065	PROLIT10A-5	Plastic hanger	5	30	0,470	213
8003910108141	PROLIT10A-5K	Plastic hanger	5	30	4,200	213
8003910108585	PROLIT16A-10	Plastic hanger	5	30	0,895	214
8003910108592	PROLIT16A-10K	Plastic hanger	5	30	0,895	214
8003910923072	PROLIT16A-3	Plastic hanger	5	30	0,390	214
8003910108134	PROLIT16A-3K	Plastic hanger	5	30	0,302	214
8003910923089	PROLIT16A-5	Plastic hanger	5	30	0,520	214
8003910108158	PROLIT16A-5K	Plastic hanger	5	30	0,446	214
8003910923096	PROLIT5-5	Plastic hanger	5	20	0,650	213
8003910107830	PS048	Colour Box	4	16	0,730	76
8003910107052	PS066	Colour Box	4	8		74
8003910110250	PS067N	Colour Box	4	8	0,000	75
8003910110267	PS068N	Colour Box	4	8	0,000	77
8003910110236	PS070S	Colour Box	4	8	0,000	78

Codice articolo	EAN	Imballo	Inner	Master	Peso Kg	Pag.	Codice articolo	EAN	Imballo	Inner	Master	Peso Kg	Pag.
8003910107083	PS100B	White box	6	6	1,329	81	8003910110373	SL373	Colour Box	1	8	0,000	102
80039101070760	PS100G	White box	6	6	1,329	82	8003910101630	SL420	Colour Box	6	6	0,865	95
8003910107106	PS100W	White box	6	6	1,300	80	8003910105058	SL528	Colour Box	4	4	0,560	103
8003910107090	PS200B	White box	6	6	2,450	81	8003910106789	SL532	Colour Box	2	2	1,072	103
8003910107687	PS200G	White box	6	6	2,460	82	8003910106796	SL561	Colour Box	2	2	1,146	104
8003910107113	PS200W	White box	6	6	2,460	80	8003910106383	SPH105	Bulk	12	12	0,610	90
8003910102293	PT310	White Box	5	5	0,690	135	8003910106390	SPH110	Bulk	12	12	1,007	90
8003910102361	PT313	White Box	5	5	0,670	136	8003910106406	SPH115	Bulk	4	4	1,810	90
8003910100411	PT330	White Box	10	10	1,170	135	8003910106413	SPH120	Bulk	4	4	2,410	90
8003910100459	PT331	White Box	10	10	1,255	138	8003910109803	SPH124	Bulk	4	4	1,670	90
8003910102330	PT333	White Box	10	10	1,135	136	8003910106352	SPH140	Bulk	10	50	0,110	90
8003910100428	PT340	White Box	5	5	2,095	135	8003910106369	SPH142	Bulk	10	50	0,160	90
8003910100503	PT342	White Box	5	5	2,320	139	8003910106376	SPH150	Bulk	10	50	0,160	90
8003910102347	PT343	White Box	5	5	1,935	136	8003910106468	SPH152	Bulk	10	50	0,190	90
8003910105041	PT363	White Box	5	5	1,324	137	8003910106437	SPH162	Bulk	6	36	0,240	90
8003910102378	PT373	White Box	5	5	2,250	137	8003910107908	SPH167	Polybag	6	24	0,387	140
8003910104921	PTLED20W	Colour Box	5	10	0,580	132	8003910108349	SPH182	Bulk	1	1	0,181	90
8003910104938	PTLED32W	Colour Box	5	10	1,250	133	8003910108356	SPH183	Bulk	1	1	0,210	90
8003910100763	PTLEDIK-E27	Colour Box	12	12	0,715	51	8003910106260	SPH200	Polybag	8	8	0,310	84
8003910900516	R03/4BP	Blister 4 pces	12	144	0,040	244	8003910106444	SPH202P	Polybag	6	6	0,395	92
8003910900530	R14/2BP	Blister 2 pces	12	72	0,150	244	8003910106277	SPH205	Polybag	8	8	0,360	84
8003910900547	R20/2BP	Blister 2 pces	10	60	0,180	244	8003910106451	SPH206P	Polybag	6	6	0,410	92
8003910900523	R6/4BP	Blister 4 pces	12	144	0,130	244	8003910106284	SPH208	Polybag	8	8	0,360	84
8003910904644	R720	Blister	6	48	0,143	164	8003910107748	SPH209P	Polybag	6	6	0,399	92
8003910101692	R720H	Blister	6	48	0,139	164	8003910106291	SPH250	Polybag	6	6	0,442	85
8003910108301	REEL-22G	Brown Box	1	1	3,084	217	8003910107939	SPH251-K	Polybag	6	6	0,316	141
8003910108318	REEL-42G	Brown Box	1	1	4,960	217	8003910107915	SPH251-U	Polybag	6	6	0,316	141
8003910104884	REEL-FR-15	Bulk	4	4	2,440	222	8003910107922	SPH251-Y	Polybag	6	6	0,316	141
8003910003392	REEL-FR-25	Bulk	1	1	3,800	222	8003910107205	SPH253	Polybag	6	6	0,459	85
8003910003408	REEL-FR-40	Bulk	1	1	5,580	222	8003910107885	SPH254	Polybag	6	6	0,454	85
8003910102170	REEL-IT-15	Brown Box	4	4	2,440	216	8003910106307	SPH255	Polybag	6	6	0,470	85
8003910102187	REEL-IT-25	Brown Box	4	4	3,795	216	8003910106314	SPH258	Polybag	6	6	0,460	85
8003910102194	REEL-IT-50	Brown Box	2	2	6,700	216	8003910107267	SPH259	Polybag	4	12	0,666	88
8003910002401	REPEL01	Blister	6	48	0,050	194	8003910106321	SPH300	Polybag	4	4	0,610	87
8003910107199	REPEL02	Polybag	12	36	0,206	194	8003910107892	SPH304	Polybag	4	4	0,610	87
8003910923133	RS10-10W	Colour Box	10	30	0,506	128	8003910106338	SPH305	Polybag	4	4	0,675	87
8003910923140	RS14-14W	Colour Box	10	30	0,580	128	8003910107229	SPH307	Polybag	4	8	0,636	86
8003910923119	RS4-4W	Colour Box	10	30	0,240	128	8003910106345	SPH308	Polybag	4	4	0,610	87
8003910923126	RS8-8W	Colour Box	10	30	0,500	128	8003910107236	SPH400	Polybag	2	2	1,300	89
8003910006409	SH001	Blister	6	48	0,250	206	8003910107250	SPH405	Polybag	2	2	1,326	89
8003910006898	SH001H.FR	Blister	6	48	0,350	218	8003910107243	SPH408	Polybag	2	2	1,335	89
8003910006430	SH004	Blister	6	48	0,249	207	8003910001060	SPK02	Display 20 pces	20	40	0,071	109
8003910923348	SH005	Blister	6	48	0,183	206	8003910001077	SPK03	Display 20 pces	20	40	0,350	109
8003910109544	SH006	Blister	6	48	0,207	207	8003910904514	SPK05	Display 24 pces	24	48	0,116	109
8003910100367	SH115	Blister	6	48	0,137	206	8003910101913	SPK08	Display 12 pces	12	12	0,066	110
8003910106802	SL2044	Colour Box	2	2	1,335	106	8003910902060	SPK10	Display 20 pces	20	40	0,300	110
8003910110182	SL2048	Colour Box	4	4	0,000	105	8003910110144	SPK12	Display 12 pces	12	12	0,000	111
8003910904620	SL210	Blister	6	24	0,175	93	8003910110168	SPK14	Display 20 pces	20	40	0,000	112
8003910101609	SL235	Colour Box	6	12	0,400	93	8003910110328	SPK16	Colour Box	6	24	0,000	112
8003910110366	SL237	Colour Box	4	16	0,000	94	8003910110175	SPK59	Colour Box	6	12	0,000	111
8003910108233	SL238	Colour Box	6	24	0,409	94	8003910101883	STARLED218	Colour Box	15	15	0,415	43
8003910106703	SL330	Colour Box	6	6	0,752	96	8003910101890	STARLED236	Colour Box	15	15	0,710	43
8003910106710	SL340	Colour Box	6	6	1,058	96	8003910101906	STARLED258	Colour Box	15	15	0,845	43
8003910106819	SL3432	Colour Box	1	1	5,817	107	8003910106536	STARRY	Colour Box	2	6	1,632	134
8003910108240	SL344	Colour Box	4	4	1,388	97	8003910100275	START22	Bulk	50	2000	0,020	229
8003910110380	SL360	Colour Box	4	16	0,000	100	8003910100282	START65	Bulk	50	2000	0,010	229
8003910110397	SL362	Colour Box	1	8	0,000	101	8003910003811	TARTARUGA-B	Shrink	12	48	0,300	54
8003910110335	SL368	Colour Box	4	16	0,000	65	8003910003668	TARTARUGA-N	Shrink	12	48	0,300	54





# INDICE ALFABETICO PRODOTTI

Alphabetical index product

Codice articolo	EAN	Imballo	Inner	Master	Peso Kg	Pag.
8003910102637	TARTARUGA-XL2	Colour Box	6	24	0,440	56
8003910102866	TARTARUGA-XXL2	Colour Box	6	24	0,500	56
8003910100657	TBLED18W-4000K	White Box	25	25	0,312	47
8003910100688	TBLED18W-6500K	White Box	25	25	0,312	47
8003910100664	TBLED22W-4000K	White Box	25	25	0,391	47
8003910100695	TBLED22W-6500K	White Box	25	25	0,391	47
8003910100640	TBLED9W-4000K	White Box	25	25	0,161	47
8003910100671	TBLED9W-6500K	White Box	25	25	0,161	47
8003910902947	THERM02	Blister	12	72	0,100	203
8003910105270	TL1010-B	Shrink	6	6	0,384	146
8003910100046	TL1201-B	Colour Box	12	12	0,850	147
8003910100053	TL1201-N	Colour Box	12	12	0,850	147
8003910104501	TL1201-S	Colour Box	12	12	0,850	147
8003910104495	TL1201-U	Colour Box	12	12	0,850	147
8003910100060	TL1203-B	Colour Box	12	12	0,505	148
8003910100077	TL1203-N	Colour Box	12	12	0,505	148
8003910100084	TL1207-N	Colour Box	6	6	1,350	149
8003910100589	TL1401-B	Colour Box	6	24	0,298	145
8003910100596	TL1401-N	Colour Box	6	24	0,298	145
8003910108066	TL1602-B	Colour Box	6	6	0,720	142
8003910108073	TL1602-N	Colour Box	6	6	0,720	142
8003910923256	TL1606B	Colour Box	4	24	1,500	143
8003910923263	TL1606N	Colour Box	4	24	0,920	143
8003910106581	TL1614	Colour Box	4	24	0,500	144
8003910105089	TL3430	Colour Box	1	1	7,000	108
8003910105492	TNE118	Colour Box	12	12	0,671	44

Codice articolo	EAN	Imballo	Inner	Master	Peso Kg	Pag.
8003910105515	TNE136	Colour Box	12	12	1,116	44
8003910105539	TNE158	Colour Box	12	12	1,406	44
8003910105508	TNE218	Colour Box	8	8	1,047	45
8003910105522	TNE236	Colour Box	8	8	1,760	45
8003910105546	TNE258	Colour Box	8	8	2,250	45
8003910101975	TRIPLITE	Bulk	10	60	0,100	218
8003910006324	TRIPOD	Colour Box	6	6	1,745	28
8003910101821	TURTLE-B	Bulk	12	24	0,480	58
8003910101838	TURTLE-N	Bulk	12	24	0,480	58
8003910102620	UBLO2	Colour Box	6	48	0,340	48
8003910106154	UBLO-XIR	Colour Box	6	24	0,400	49
8003910104464	UBLO-XXL2	Colour Box	6	24	0,520	50
8003910110342	VENT-BOX4	Colour Box	1	1		189
8003910104709	VENT-CEL32	Colour Box	1	1	6,100	191
8003910104716	VENT-CEL33	Colour Box	1	1	4,900	191
8003910108011	VENT-COLT4	Colour Box	1	1	2,252	190
8003910104648	VENT-M30T3	Colour Box	1	1	3,293	187
8003910104655	VENT-M40C3	Colour Box	1	1	6,700	187
8003910110359	VENT-P23T4	Colour Box	6	6		184
8003910107991	VENT-P30T4	Colour Box	1	1	2,049	184
8003910107984	VENT-P40C4	Colour Box	1	1	2,776	185
8003910106857	VENT-P40RC	Colour Box	2	2	4,947	186
8003910108004	VENT-P40T4	Colour Box	1	1	2,327	184
8003910108028	VENT-TURB4	Colour Box	1	1	4,758	188
8003910106871	VENT-USB	Colour Box	6	30	0,295	183

## LEGENDA FORMATI BLISTER

Tipo di imballo	INNER	MASTER
 / 	 pcs	 pcs
Blister F2	12	144

Per ogni prodotto imballato in blister Velamp fa riferimento a 9 standard dimensionali che trovate illustrati qui sotto.

Tutti i nostri blister sono OMOTETICI per consentire:

- risparmio di spazio
- miglior efficienza commerciale

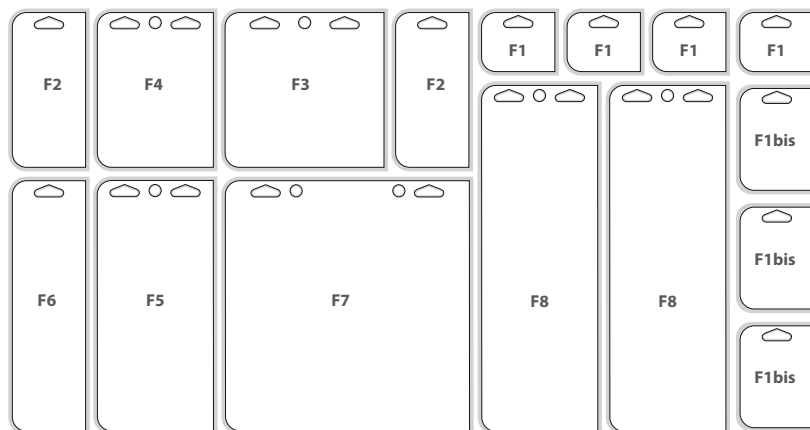

<b>F1</b>	10(L) x 20 (H) cm
<b>F1bis</b>	10(L) x 13,5 (H) cm
<b>F2</b>	10(L) x 20 (H) cm
<b>F3</b>	20,5 (L) x 20 (H) cm
<b>F4</b>	15,25 (L) x 20 (H) cm
<b>F5</b>	15,25 (L) x 31,75 (H) cm
<b>F6</b>	10 (L) x 31,75 (H) cm
<b>F7</b>	31 (L) x 31,75 (H) cm
<b>F8</b>	15,25 (L) x 43,5 (H) cm



Edizione 01/2022

VELAMP INDUSTRIES SRL - Viale Italia 59 - 20094 Corsico (MI) Italy  
Tel. +39 02.45.10.08.07 - Fax +39 02.44.01.627 - info@velamp.com - www.velamp.com

Velamp Industries France SARL SIRET : 7888 10869 00016 APE : 4791B - 6, Rue Edouard Nignon BP 37201 -  
44372 Nantes CEDEX 3

Tel. +33 2 44 84 69 66 - Fax +33 2 44 84 69 49 - spadulazzi@velamp.com

Velamp Industries Deutschland GmbH -Westerbachstrasse 23f, 61476 Kronberg  
Tel. +49 171 83 17 407 - c.bajjalj@velamp.com

CATGEN2022



8 003910 110489 >