

CABLE TRAYS

KBSI

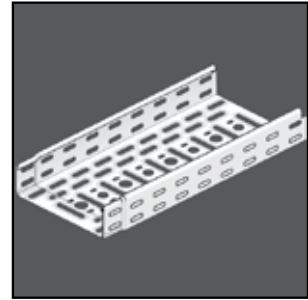

KBS

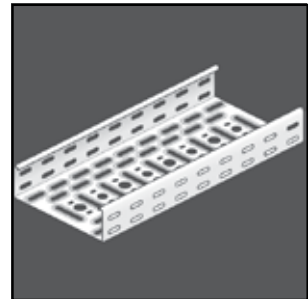

KGI / KG

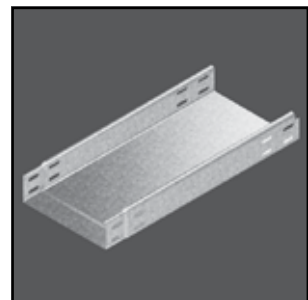

NATO

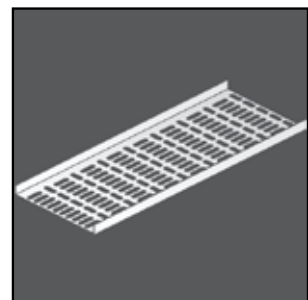

CABLE TRAYS

KBSI		
KBSI35	Cable tray with interlocking ends	1-6
KBSI60.060	Cable tray with interlocking ends	1-7
KBSI60	Cable tray with interlocking ends	1-8
KBSI60.6	Cable tray with interlocking ends	1-9
KBS		
KBS35	Perforated cable tray	1-10
KBS60	Perforated cable tray	1-11
KBS85	Perforated cable tray	1-12
KBS110	Perforated cable tray	1-13
KBS110.6	Perforated cable tray	1-14
KBSM(I)		
KBSM(I)60	Cable tray machine constr. interl. ends	1-15
KGI		
KGI60	Cable tray not perforated, interlocking	1-16
KGI60S	KGI with SIN	1-17
KG		
KG110	Cable tray not perforated	1-18
KG110S	KG with SIN	1-19
NATO		
NATO15	Perforated cable tray - upright flanges	1-20
COVER		
D	Universal cover	1-20
DZ	Cover with swivel clamp	1-21
COVER CLAMPS		
DCO	Cover clamp	1-21
DCL	Cover clamp clips	1-21
DZK	Swivel clamp	1-22
ACCESSORIES		
B90	Horizontal bend 90°	1-22
DB90	Cover for horizontal bend 90°	1-23
VH	Adjustable Corner	1-23
T	Horizontal T-piece	1-24
DT	Cover for horizontal T-piece	1-24
AS	Horizontal adapter 90°	1-25
DAS	Cover for horizontal adapter 90°	1-25
KR	Cross-over	1-26
DKR	Cover for cross-over	1-26
SB90	Rising elbow 90°	1-27
SBCL	Snap-in rising elbow 90°	1-27
DSB90	Cover for rising elbow 90°	1-28
VB90	Low elbow 90°	1-28
VBCL	Snap-in low elbow 90°	1-29
DVB90	Cover for low elbow 90°	1-29
SDB	Hinged joiner double	1-30
DS	Hinged joiner	1-30
AZH	Universal coupling 90°	1-31
BVSI	Stiffening plate	1-31
VS	Reducing plate	1-32
E	End piece	1-32
RBKBSM	Edge protection KBSM(I)	1-33
MOUNTING PLATES		
MP	Folded mounting plate	1-33
MPV	Flat mounting plate	1-33
MPVCL	Snap-in mounting plate	1-34
SEPERATORS		
SLOS	Bolt-in partition	1-34
SLIS	Snap-in partition	1-34
CL	Clips for SLIS	1-35
JOINING PLATE		
V15.200	Joining plate	1-35
V35	Joiner for fast mounting	1-35

V60	Joiner for fast mounting	1-36
V85	Joiner for fast mounting	1-36
V35.200	Joining plate	1-36
V60.200	Joining plate	1-37
V85.200	Joining plate	1-37
V110.200	Joiner	1-37
KPW	Joiner for wide-span	1-38
LV	Supporting corner	1-38
KBV	Fast locking for KBSI	1-38
	TECHNICAL INFORMATION	1-39

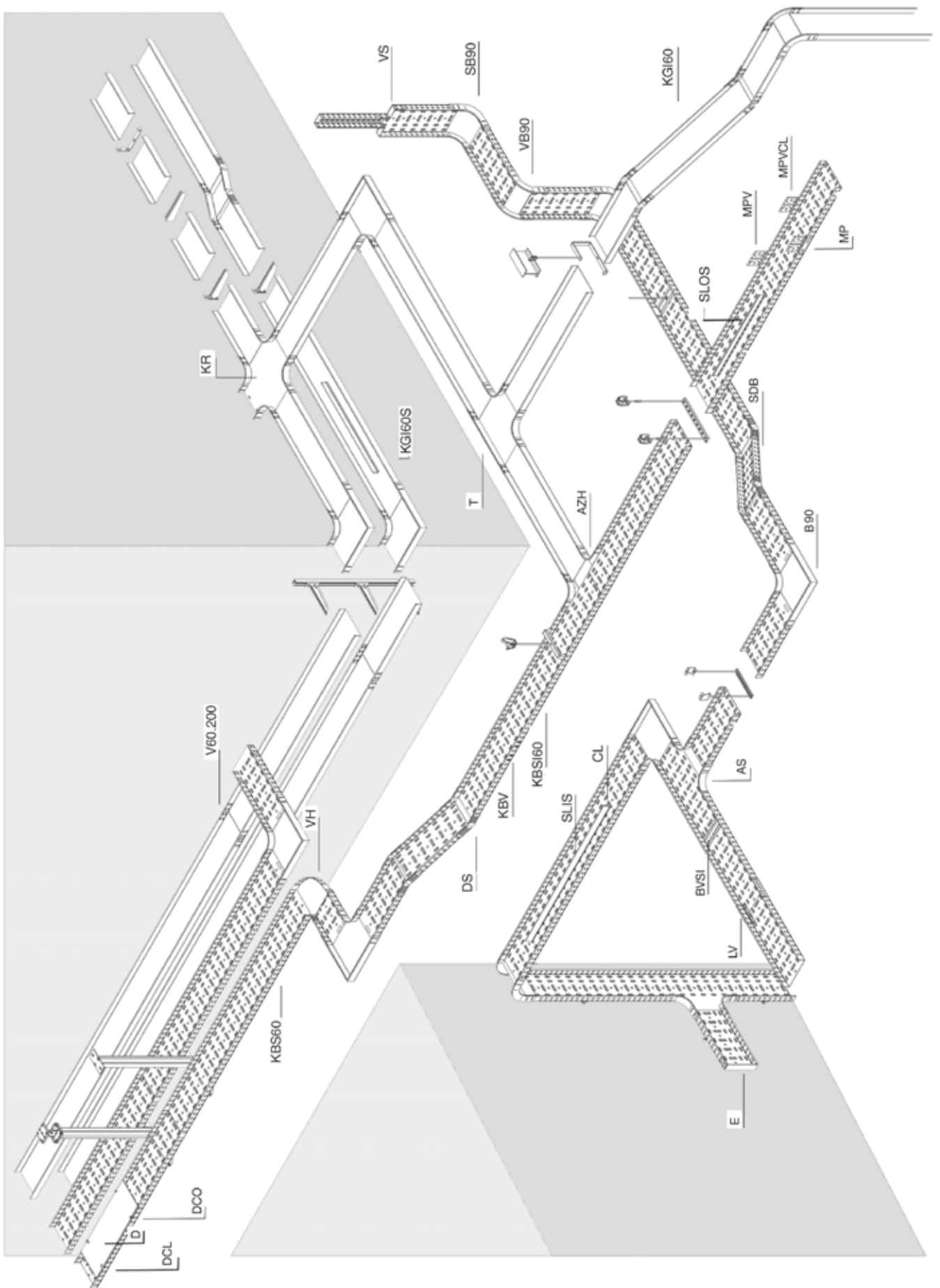

KBSI35

Cable tray with interlocking ends



Interlocking ends
Alternative perforations
Return flanges

Standard finish	Pre-galvanised
Optional finish HD	Hot-dip galvanised
Optional finish PE	Coating

HD	Reference	↑ mm	↔ mm	↔ mm	↔ mm	kg/m	⊠	Stock	Unit
HD	KBSI35.075.075	35	75	0.75	3000	0.810	60	✓	m
HD	KBSI35.075.100	35	75	1.00	3000	1.080	60	✓	m
HD	KBSI35.100.075	35	100	0.75	3000	0.930	60	✓	m
HD	KBSI35.100.100	35	100	1.00	3000	1.240	60	✓	m
HD	KBSI35.150.075	35	150	0.75	3000	1.170	60	✓	m
HD	KBSI35.150.100	35	150	1.00	3000	1.560	60	✓	m
HD	KBSI35.200.075	35	200	0.75	3000	1.420	60	✓	m
HD	KBSI35.200.100	35	200	1.00	3000	1.890	60	✓	m
HD	KBSI35.300.075	35	300	0.75	3000	1.910	60	✓	m
HD	KBSI35.300.100	35	300	1.00	3000	2.540	60	✓	m

Fix with:

-	KBV	-	-	-	-	0.001	100	✓	piece
HD	VM6.10	-	-	M6	10	0.008	100	✓	piece

LOAD DIAGRAM

This diagram illustrates the permissible uniformly distributed loads applied to multiple supports. They comply with IEC 61537 with connection to 1/5 of the span and the end span = 0,8x the span.

F = max. admissible load (daN/m)
L = support distance (m)
Max. deflection (m) = L/100

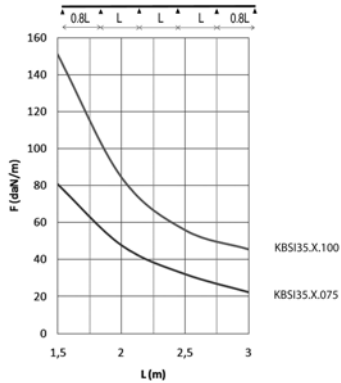

CHARACTERISTICS

Embedded perforations for:

- extra load capacity
- better aeration
- better stability
- better condensation drainage

Alternative perforations for:

- better fixing to supports
- very useful for attaching cables

Earthing.

TECHNICAL INFORMATION

The perforation scheme differs according to the width.

The surface of the interlocking end is rounded in order to protect the cables.

Round holes of Ø 16 mm and Ø 19.5 mm provided as opening for the fitting of a gland.

KBSI60.060

Cable tray with interlocking ends

Interlocking ends
Alternative perforations
Return flanges

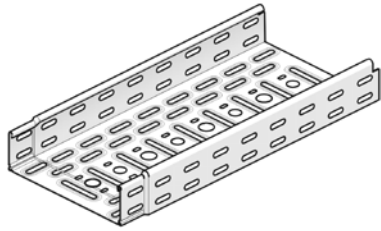

Standard finish

Pre-galvanised

HD	Reference	↑ mm	↔ mm	↗ mm	↘ mm	kg/m	⊞	Stock	Unit
-	KBSI60.100.060	60	100	0.60	3000	0.936	810	✓	m
-	KBSI60.200.060	60	200	0.60	3000	1.328	450	✓	m
-	KBSI60.300.060	60	300	0.60	3000	1.720	306	✓	m

Fix with:

-	KBV	-	-	-	-	0.001	100	✓	piece
HD	VM6.10	-	-	M6	10	0.008	100	✓	piece

LOAD DIAGRAM

This diagram illustrates the permissible uniformly distributed loads applied to multiple supports. They comply with IEC 61537 with connection in the centre of the span and the end span = 0,8x the span.

F = max. admissible load (daN/m)

L = support distance (m)

Max. deflection (m) = L/100

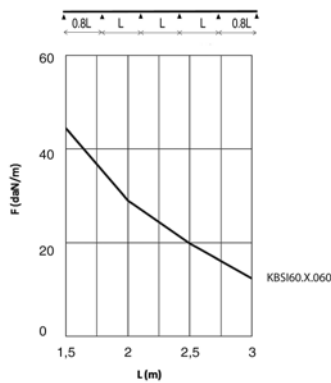

To order per full packaging.

KBSI60

Cable tray with interlocking ends

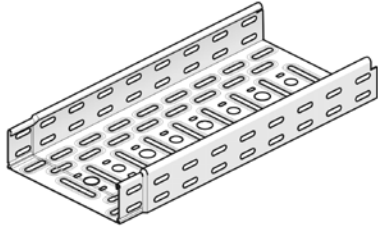

Interlocking ends
Alternative perforations
Return flanges

Standard finish	Pre-galvanised
Optional finish HD	Hot-dip galvanised
Optional finish PE	Coating

HD	Reference	↑ mm	↔ mm	↔ mm	↔ mm	kg/m	⊠	Stock	Unit
HD	KBSI60.075.075	60	75	0.75	3000	1.050	60	✓	m
HD	KBSI60.075.100	60	75	1.00	3000	1.400	60	✓	m
-	KBSI60.075.125	60	75	1.25	3000	1.750	60	✓	m
HD	KBSI60.100.075	60	100	0.75	3000	1.170	60	✓	m
HD	KBSI60.100.100	60	100	1.00	3000	1.560	60	✓	m
-	KBSI60.100.125	60	100	1.25	3000	1.950	60	✓	m
HD	KBSI60.150.075	60	150	0.75	3000	1.420	30	✓	m
HD	KBSI60.150.100	60	150	1.00	3000	1.890	30	✓	m
-	KBSI60.150.125	60	150	1.25	3000	2.360	30	✓	m
HD	KBSI60.200.075	60	200	0.75	3000	1.660	30	✓	m
HD	KBSI60.200.100	60	200	1.00	3000	2.220	30	✓	m
-	KBSI60.200.125	60	200	1.25	3000	2.770	30	✓	m
HD	KBSI60.250.075	60	250	0.75	3000	1.910	30	✓	m
HD	KBSI60.250.100	60	250	1.00	3000	2.540	30	✓	m
HD	KBSI60.300.075	60	300	0.75	3000	2.150	30	✓	m
HD	KBSI60.300.100	60	300	1.00	3000	2.870	30	✓	m
-	KBSI60.300.125	60	300	1.25	3000	3.580	30	✓	m
HD	KBSI60.400.100	60	400	1.00	3000	3.520	30	✓	m
-	KBSI60.400.125	60	400	1.25	3000	4.400	30	✓	m
HD	KBSI60.500.100	60	500	1.00	3000	4.170	30	✓	m
-	KBSI60.500.125	60	500	1.25	3000	5.210	30	✓	m
HD	KBSI60.600.100	60	600	1.00	3000	4.820	30	✓	m
-	KBSI60.600.125	60	600	1.25	3000	6.030	30	✓	m

Fix with:									
-	KBV	-	-	-	-	0.001	100	✓	piece
HD	VM6.10	-	-	M6	10	0.008	100	✓	piece

LOAD DIAGRAM

This diagram illustrates the permissible uniformly distributed loads applied to multiple supports. They comply with IEC 61537 with connection in the centre of the span and the end span = 0,8x the span.

F = max. admissible load (daN/m)
L = support distance (m)
Max. deflection (m) = L/100

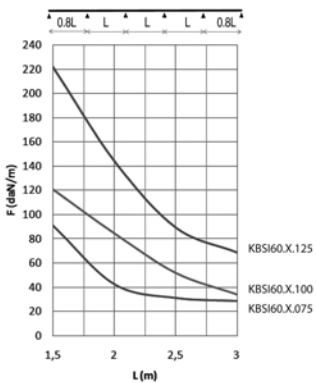

The technical information for this product can be found at the end of this chapter.

Other lengths on request: min. 1.80 m / max. 6 m per steps of 100 mm.

KBSI60.6

Cable tray with interlocking ends

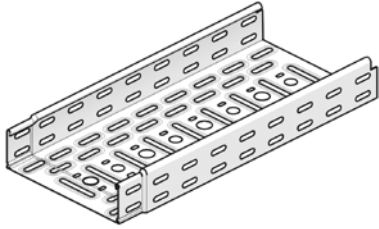

Interlocking ends
Alternative perforations
Return flanges

Standard finish

Pre-galvanised

Optional finish PE

Coating

HD	Reference	↑ mm	↔ mm	↔ mm	↔ mm	kg/m	⊠	Stock	Unit
-	KBSI60.075.100.6	60	75	1.00	6000	1.400	60	✓	m
-	KBSI60.100.100.6	60	100	1.00	6000	1.560	60	✓	m
-	KBSI60.150.100.6	60	150	1.00	6000	1.890	30	✓	m
-	KBSI60.200.100.6	60	200	1.00	6000	2.220	30	✓	m
-	KBSI60.300.100.6	60	300	1.00	6000	2.870	30	✓	m
-	KBSI60.400.100.6	60	400	1.00	6000	3.520	30	✓	m
Fix with:									
HD VM6.10	-	-	M6	10	0.008	100	✓	piece	

LOAD DIAGRAM

This diagram illustrates the permissible uniformly distributed loads applied to multiple supports. They comply with IEC 61537 with connection to 1/5 of the span and the end span = 0,8x the span.

F = max. admissible load (daN/m)

L = support distance (m)

Max. deflection (m) = L/100

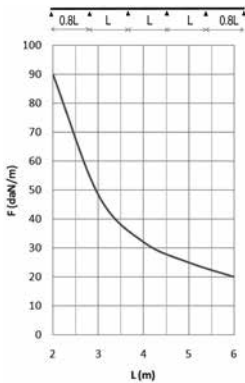

Other lengths on request: min. 1.80 m / max. 6 m per steps of 100 mm.

CHARACTERISTICS

Embedded perforations for:

- extra load capacity
- better aeration
- better stability
- better condensation drainage

Alternative perforations for:

- better fixing to supports
- very useful for attaching cables

Earthing.

TECHNICAL INFORMATION

The perforation scheme differs according to the width.

Alternative perforation beginning at width 200 mm.

The surface of the interlocking end is rounded in order to protect the cables.

Round holes of Ø 16 mm and Ø 19.5 mm provided as opening for the fitting of a gland.

Separation SLIS60 can be used on any width from 200 mm and up.

KBS35

Perforated cable tray

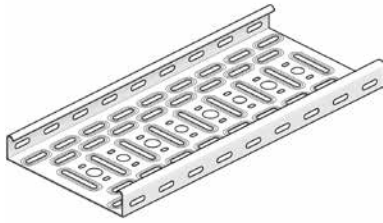

Alternative perforation
Return flanges

Standard finish	Pre-galvanised
Optional finish HD	Hot-dip galvanised
Optional finish PE	Coating

HD	Reference	↑ mm	↔ mm	↔ mm	↔ mm	kg/m	⊞	Stock	Unit
HD	KBS35.050.075	35	50	0.75	3000	0.680	150	✓	m
HD	KBS35.050.100	35	50	1.00	3000	0.912	150	✓	m
HD	KBS35.400.100	35	400	1.00	3000	3.190	60	✓	m
HD	KBS35.500.100	35	500	1.00	3000	3.840	60	✓	m
HD	KBS35.600.100	35	600	1.00	3000	4.500	60	✓	m

Fix with:									
HD	V35.200	25	200	-	-	0.040	48	✓	piece
-	V35	27	180	-	-	0.050	48	✓	piece
HD	VM6.10	-	-	M6	10	0.008	100	✓	piece

LOAD DIAGRAM

This diagram illustrates the permissible uniformly distributed loads applied to multiple supports. They comply with IEC 61537 with connection in the centre of the span and the end span = 0,8x the span. For widths of 300 and up, it is advised to use a stiffening plate.

F = max. admissible load (daN/m)
L = support distance (m)
Max. deflection (m) = L/100

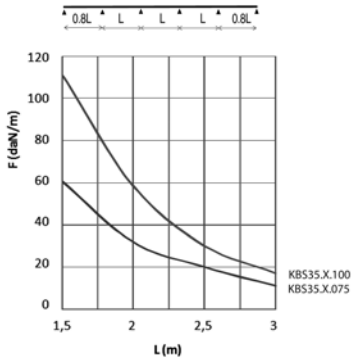

CHARACTERISTICS

Embedded perforations for:
- extra load capacity
- better aeration
- better stability
- better condensation drainage

Alternative perforations for:
- better fixing to supports
- very useful for attaching cables

TECHNICAL INFORMATION

The perforation scheme differs according to the width.
Alternative perforation beginning at 200 mm.
Round holes of Ø 16 mm and Ø 19.5 mm provided as opening for the fitting of a gland.
KBS35.050.075 en KBS35.050.100: no knock-out facility (pre-shaped holes).

KBS60

Perforated cable tray

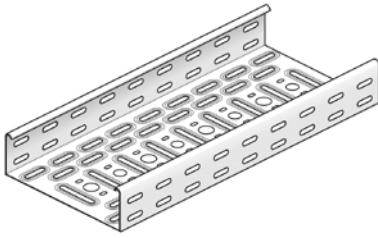

Alternative perforation
Return flanges

Standard finish

Pre-galvanised

Optional finish HD

Hot-dip galvanised

Optional finish PE

Coating

HD	Reference	↑ mm	↔ mm	⊘ mm	↔ mm	kg/m	⊠	Stock	Unit
HD	KBS60.050.075	60	50	0.75	3000	0.930	60	✓	m
HD	KBS60.050.100	60	50	1.00	3000	1.240	60	✓	m
HD	KBS60.075.100	60	75	1.00	3000	1.400	60	✓	m
HD	KBS60.075.125	60	75	1.25	3000	1.750	60	✓	m
HD	KBS60.100.100	60	100	1.00	3000	1.560	60	✓	m
HD	KBS60.100.125	60	100	1.25	3000	1.950	60	✓	m
HD	KBS60.100.150	60	100	1.50	3000	2.350	60	✓	m
HD	KBS60.150.100	60	150	1.00	3000	1.890	30	✓	m
HD	KBS60.150.125	60	150	1.25	3000	2.360	30	✓	m
HD	KBS60.150.150	60	150	1.50	3000	2.830	30	✓	m
HD	KBS60.200.100	60	200	1.00	3000	2.220	30	✓	m
HD	KBS60.200.125	60	200	1.25	3000	2.770	30	✓	m
HD	KBS60.200.150	60	200	1.50	3000	3.320	30	✓	m
HD	KBS60.250.100	60	250	1.00	3000	2.540	30	✓	m
HD	KBS60.300.100	60	300	1.00	3000	2.870	30	✓	m
HD	KBS60.300.125	60	300	1.25	3000	3.580	30	✓	m
HD	KBS60.300.150	60	300	1.50	3000	4.300	30	✓	m
HD	KBS60.400.100	60	400	1.00	3000	3.520	30	✓	m
HD	KBS60.400.125	60	400	1.25	3000	4.400	30	✓	m
HD	KBS60.400.150	60	400	1.50	3000	5.280	30	✓	m
HD	KBS60.500.100	60	500	1.00	3000	4.170	30	✓	m
HD	KBS60.500.125	60	500	1.25	3000	5.210	30	✓	m
HD	KBS60.500.150	60	500	1.50	3000	6.250	30	✓	m
HD	KBS60.600.125	60	600	1.25	3000	6.030	30	✓	m
HD	KBS60.600.150	60	600	1.50	3000	7.230	30	✓	m

Fix with:

HD	V60.200	50	200	-	-	0.080	48	✓	piece
-	V60	52	180	-	-	0.090	48	✓	piece
HD	VM6.10	-	-	M6	10	0.008	100	✓	piece

LOAD DIAGRAM

This diagram illustrates the permissible uniformly distributed loads applied to multiple supports. They comply with IEC 61537 with connection in the centre of the span and the end span = 0,8x the span. For widths of 300 and up, it is advised to use a stiffening plate.

F = max. admissible load (daN/m)

L = support distance (m)

Max. deflection (m) = L/100

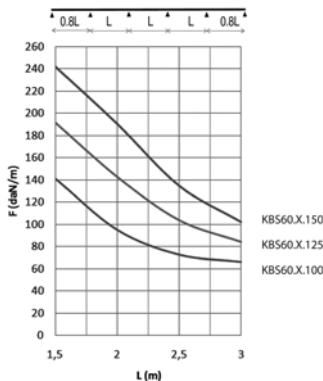

Round holes of Ø 16 mm and Ø 19.5 mm provided as opening for the fitting of a gland.
KBS60.050.075 and KBS60.050.100: No knock-out facility (pre-shaped holes).

KBS85

Perforated cable tray

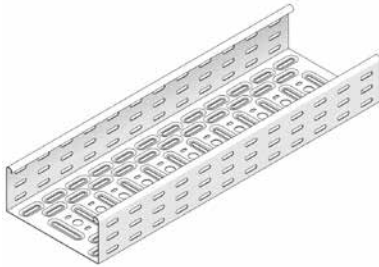

Alternative perforation
Return flanges

Standard finish	Pre-galvanised
Optional finish HD	Hot-dip galvanised
Optional finish PE	Coating

HD	Reference	↑ mm	↔ mm	⊘ mm	↔ mm	kg/m	⊠	Stock	Unit
HD	KBS85.100.100	85	100	1.00	3000	1.890	24	✓	m
HD	KBS85.150.100	85	150	1.00	3000	2.220	24	✓	m
HD	KBS85.200.100	85	200	1.00	3000	2.540	24	✓	m
HD	KBS85.300.100	85	300	1.00	3000	3.190	24	✓	m
HD	KBS85.400.100	85	400	1.00	3000	3.840	24	✓	m
HD	KBS85.400.150	85	400	1.50	3000	5.770	24	✓	m
HD	KBS85.500.125	85	500	1.25	3000	5.620	24	✓	m
HD	KBS85.500.150	85	500	1.50	3000	6.740	24	✓	m
HD	KBS85.600.125	85	600	1.25	3000	6.430	24	✓	m
HD	KBS85.600.150	85	600	1.50	3000	7.720	24	✓	m

Fix with:

HD	V85.200	75	200	-	-	0.130	48	✓	piece
-	V85	77	180	-	-	0.130	48	✓	piece
HD	VM6.10	-	-	M6	10	0.008	100	✓	piece

LOAD DIAGRAM

This diagram illustrates the permissible uniformly distributed loads applied to multiple supports. They comply with IEC 61537 with connection in the centre of the span and the end span = 0,8x the span. For widths of 300 and up, it is advised to use a stiffening plate.

F = max. admissible load (daN/m)
L = support distance (m)
Max. deflection (m) = L/100

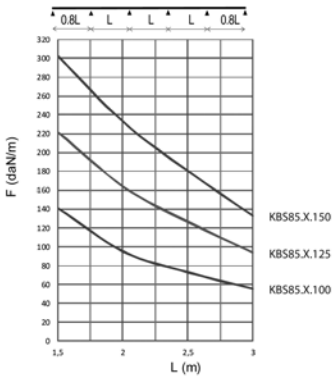

CHARACTERISTICS

Embedded perforations for:

- extra load capacity
- better aeration
- better stability
- better condensation drainage

Alternative perforations for:

- better fixing to supports
- very useful for attaching cables

TECHNICAL INFORMATION

The perforation scheme differs according to the width.

Alternative perforation beginning at 200 mm.

Round holes of Ø 16 mm and Ø 19.5 mm provided as opening for the fitting of a gland.

KBS110

Perforated cable tray

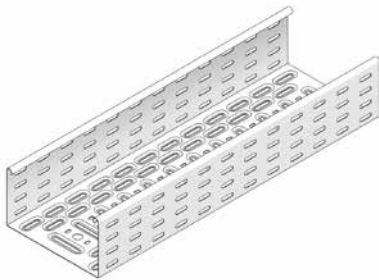

Alternative perforation
Return flanges

Standard finish Pre-galvanised

Optional finish HD Hot-dip galvanised

Optional finish PE Coating

HD	Reference	↑ mm	↔ mm	⊘ mm	↔ mm	kg/m	⊠	Stock	Unit
HD	KBS110.150.125	110	150	1.25	3000	3.180	24	✓	m
HD	KBS110.200.125	110	200	1.25	3000	3.580	24	✓	m
HD	KBS110.300.125	110	300	1.25	3000	4.400	24	✓	m
HD	KBS110.400.125	110	400	1.25	3000	5.210	24	✓	m
HD	KBS110.500.125	110	500	1.25	3000	6.030	24	✓	m
HD	KBS110.500.150	110	500	1.50	3000	7.230	24	✓	m
HD	KBS110.600.125	110	600	1.25	3000	6.840	24	✓	m
HD	KBS110.600.150	110	600	1.50	3000	8.210	24	✓	m

Fix with:

HD	V110.200	100	200	-	-	0.170	48	✓	piece
HD	VM6.10	-	-	M6	10	0.008	100	✓	piece
HD	KPW	115	400	-	-	0.590	24	✓	piece

LOAD DIAGRAM

This diagram illustrates the permissible uniformly distributed loads applied to multiple supports. They comply with IEC 61537 with connection in the centre of the span and the end span = 0,8x the span. For widths of 300 and up, it is advised to use a stiffening plate. For span distances > 4 meters, couple the cable trays with KPW

F = max. admissible load (daN/m)

L = support distance (m)

Max. deflection (m) = L/100

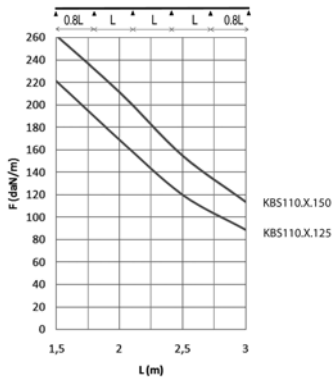

CHARACTERISTICS

Embedded perforations for:

- extra load capacity
- better aeration
- better stability
- better condensation drainage

Alternative perforations for:

- better fixing to supports
- very useful for attaching cables

TECHNICAL INFORMATION

The perforation scheme differs according to the width.

Alternative perforation beginning at 200 mm.

Round holes of Ø 16 mm and Ø 19.5 mm provided as opening for the fitting of a gland.

KBS110.6

Perforated cable tray

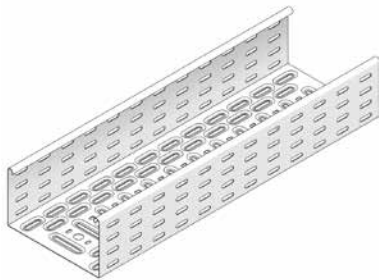

Alternative perforation
Return flanges
Support distance up to 6 meter

Standard finish Pre-galvanised

Optional finish HD Hot-dip galvanised

Optional finish PE Coating

HD	Reference	↑ mm	↔ mm	↔ mm	↔ mm	kg/m	⊠	Stock	Unit
HD	KBS110.200.150.6	110	200	1.50	6000	4.300	24	✓	m
HD	KBS110.300.150.6	110	300	1.50	6000	5.280	24	✓	m
HD	KBS110.400.150.6	110	400	1.50	6000	6.250	24	✓	m
HD	KBS110.500.150.6	110	500	1.50	6000	7.230	24	✓	m
HD	KBS110.600.150.6	110	600	1.50	6000	8.210	24	✓	m

Fix with:

HD	KPW	115	400	-	-	0.590	24	✓	piece
HD	VM6.10	-	-	M6	10	0.008	100	✓	piece
HD	V110.200	100	200	-	-	0.170	48	✓	piece

LOAD DIAGRAM

This diagram illustrates the permissible uniformly distributed loads applied to multiple supports. They comply with IEC 61537 with connection in the centre of the span and the end span = 0,8x the span. For widths of 300 mm and up, it is advised to use a stiffening plate. For span distances > 4 meters, couple the cable trays with KPW.

F = max. admissible load (daN/m)

L = support distance (m)

Max. deflection (m) = L/100

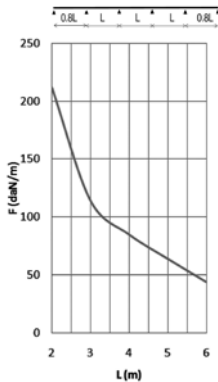

CHARACTERISTICS

Embedded perforations for:

- extra load capacity
- better aeration
- better stability
- better condensation drainage

Alternative perforations for:

- better fixing to supports
- very useful for attaching cables.

TECHNICAL INFORMATION

The perforation scheme differs according to the width.

Alternative perforation beginning at 200 mm.

Round holes of Ø 16 mm and Ø 19.5 mm provided as opening for the fitting of a gland.

KBSM(I)60

Cable tray machine constr. interl. ends

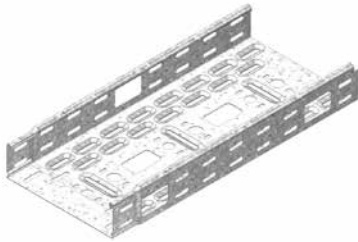

Can be used with RBKBSM

Alternative perforation
Return flanges

Standard finish	Pre-galvanised
Optional finish PE	Coating

HD	Reference	↑ mm	↔ mm	↔ mm	↔ mm	kg/m	⊠	Stock	Unit
-	KBSM60.050.100	60	50	1.00	3000	1.240	3	✓	m
-	KBSM60.075.100	60	75	1.00	3000	1.400	3	✓	m
-	KBSM60.100.100	60	100	1.00	3000	1.560	3	✓	m
-	KBSM60.150.100	60	150	1.00	3000	1.890	3	✓	m
-	KBSM60.200.100	60	200	1.00	3000	2.220	3	✓	m
-	KBSM60.300.100	60	300	1.00	3000	2.870	3	✓	m

Fix with:									
-	KBV	-	-	-	-	0.001	100	✓	piece
HD	VM6.10	-	-	M6	10	0.008	100	✓	piece

LOAD DIAGRAM

This diagram illustrates the permissible uniformly distributed loads applied to multiple supports. They comply with IEC 61537 par 10.3.3 test type III with connection to 1/5 of the span.

F = max. admissible load (daN/m)

L = support distance (m)

Max. deflection (m) = L/100

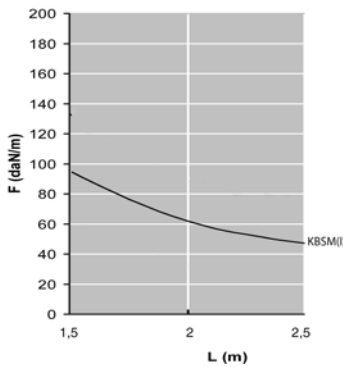

The technical information for this product can be found at the end of this chapter.

CHARACTERISTICS

- The cable outlet holes allow the cable trays to be used in machine constructions, especially in the field of internal transport.
- Can be used as lighting rail by immediately connecting through bottom perforations M16 and M20.
- Staggered slots in sides and bottom for easy connection with accessories.
- To be used with standard accessories, such as the cover with swivel clamp.

TECHNICAL INFORMATION

- Interlocking from width 75 mm (connect width 50 mm with joining plate)
- Large cable outlet with round corners (dimensions 30x50 mm)
- Distance between cable outlets: bottom = 150 mm, sides = 300 mm
- Edge protection RBKBSM to order separately
- Round cable gland central to the bottom, alternately M16/M20

KGI60

Cable tray not perforated, interlocking



Not perforated
Return flanges

To order	Height 35 mm
Standard finish	Pre-galvanised
Optional finish HD	Hot-dip galvanised
Optional finish PE	Coating

HD	Reference	↑ mm	↔ mm	↔ mm	↔ mm	kg/m	⊞	Stock	Unit
HD	KGI60.075.100	60	75	1.00	3000	1.700	3	✓	m
HD	KGI60.100.100	60	100	1.00	3000	1.900	3	✓	m
HD	KGI60.150.100	60	150	1.00	3000	2.300	3	✓	m
HD	KGI60.200.100	60	200	1.00	3000	2.700	3	✓	m
HD	KGI60.250.100	60	250	1.00	3000	3.100	3	✓	m
HD	KGI60.300.100	60	300	1.00	3000	3.500	3	✓	m
-	KGI60.300.125	60	300	1.25	3000	4.300	3	✓	m
HD	KGI60.400.100	60	400	1.00	3000	4.300	3	✓	m
-	KGI60.400.125	60	400	1.25	3000	5.300	3	✓	m
-	KGI60.500.125	60	500	1.25	3000	6.300	3	✓	m
-	KGI60.600.125	60	600	1.25	3000	7.300	3	✓	m

Fix with:									
-	KBV	-	-	-	-	0.001	100	✓	piece
HD	VM6.10	-	-	M6	10	0.008	100	✓	piece

LOAD DIAGRAM

This diagram illustrates the permissible uniformly distributed loads applied to multiple supports. They comply with IEC 61537 with connection in the centre of the span and the end span = 0,8x the span.

F = max. admissible load (daN/m)

L = support distance (m)

Max. deflection (m) = L/100

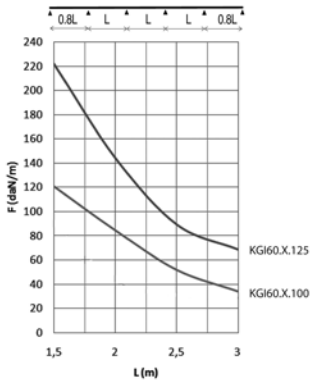

KGI60S

KGI with SIN



Not perforated
Return flanges

To order	Height 35 mm
Standard finish	Pre-galvanised
Optional finish HD	Hot-dip galvanised
Optional finish PE	Coating

HD	Reference	↑ mm	↔ mm	↔ mm	↔ mm	kg/m	⊠	Stock	Unit
HD	KGI60.075.100S12	60	75	1.00	3000	2.211	30		m
HD	KGI60.075.100S13	60	75	1.00	3000	2.211	30		m
HD	KGI60.075.100S23	60	75	1.00	3000	2.722	30		m
HD	KGI60.100.100S12	60	100	1.00	3000	2.411	30		m
HD	KGI60.100.100S13	60	100	1.00	3000	2.411	30		m
HD	KGI60.100.100S23	60	100	1.00	3000	2.922	30		m
HD	KGI60.150.100S12	60	150	1.00	3000	2.811	30		m
HD	KGI60.150.100S13	60	150	1.00	3000	2.811	30		m
HD	KGI60.150.100S23	60	150	1.00	3000	3.322	30		m
HD	KGI60.200.100S12	60	200	1.00	3000	3.211	30		m
HD	KGI60.200.100S13	60	200	1.00	3000	3.211	30		m
HD	KGI60.200.100S23	60	200	1.00	3000	3.722	30		m
HD	KGI60.250.100S12	60	250	1.00	3000	3.611	30		m
HD	KGI60.250.100S13	60	250	1.00	3000	3.611	30		m
HD	KGI60.250.100S23	60	250	1.00	3000	4.122	30		m
HD	KGI60.300.100S12	60	300	1.00	3000	4.011	30		m
HD	KGI60.300.100S13	60	300	1.00	3000	4.011	30		m
HD	KGI60.300.100S23	60	300	1.00	3000	4.522	30		m
-	KGI60.300.125S12	60	300	1.25	3000	4.811	30		m
-	KGI60.300.125S13	60	300	1.25	3000	4.811	30		m
-	KGI60.300.125S23	60	300	1.25	3000	5.322	30		m
HD	KGI60.400.100S12	60	400	1.00	3000	4.811	30		m
HD	KGI60.400.100S13	60	400	1.00	3000	4.811	30		m
HD	KGI60.400.100S23	60	400	1.00	3000	5.322	30		m
-	KGI60.400.125S12	60	400	1.25	3000	5.811	30		m
-	KGI60.400.125S13	60	400	1.25	3000	5.811	30		m
-	KGI60.400.125S23	60	400	1.25	3000	6.322	30		m
-	KGI60.500.125S12	60	500	1.25	3000	6.811	30		m
-	KGI60.500.125S13	60	500	1.25	3000	6.811	30		m
-	KGI60.500.125S23	60	500	1.25	3000	7.322	30		m
-	KGI60.600.125S12	60	600	1.25	3000	7.811	30		m
-	KGI60.600.125S13	60	600	1.25	3000	7.811	30		m
-	KGI60.600.125S23	60	600	1.25	3000	8.322	30		m

Fix with:

-	KBV	-	-	-	-	0.001	100	✓	piece
HD	VM6.10	-	-	M6	10	0.008	100	✓	piece

LOAD DIAGRAM

This diagram illustrates the permissible uniformly distributed loads applied to multiple supports. They comply with IEC 61537 with connection in the centre of the span and the end span = 0,8x the span.

F = max. admissible load (daN/m)

L = support distance (m)

Max. deflection (m) = L/100

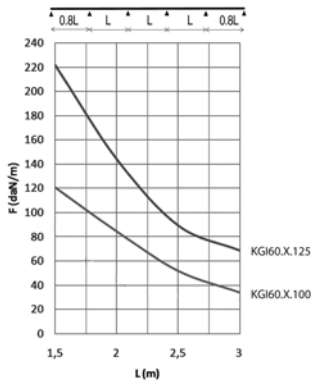

S12: one partition in the middle of the cable tray

S13: one partition at right or the left of the cable tray

S23: two partitions

KG110

Cable tray not perforated



Not perforated
Return flanges

To order	Height 85 mm
Standard finish	Pre-galvanised
Optional finish HD	Hot-dip galvanised
Optional finish PE	Coating

HD	Reference	↑ mm	↔ mm	↔ mm	↔ mm	kg/m	⊞	Stock	Unit
HD	KG110.100.150	110	100	1.50	3000	4.000	18	✓	m
HD	KG110.150.150	110	150	1.50	3000	4.590	18	✓	m
HD	KG110.200.150	110	200	1.50	3000	5.180	18	✓	m
HD	KG110.300.150	110	300	1.50	3000	6.360	18	✓	m
HD	KG110.400.150	110	400	1.50	3000	7.540	18	✓	m
HD	KG110.500.150	110	500	1.50	3000	8.710	18	✓	m
HD	KG110.600.150	110	600	1.50	3000	9.890	18	✓	m

Fix with:

HD	V110.200	100	200	-	-	0.170	48	✓	piece
HD	VM6.10	-	-	M6	10	0.008	100	✓	piece

LOAD DIAGRAM

This diagram illustrates the permissible uniformly distributed loads applied to multiple supports. They comply with IEC 61537 with connection in the centre of the span and the end span = 0,8x the span.

F = max. admissible load (daN/m)

L = support distance (m)

Max. deflection (m) = L/100

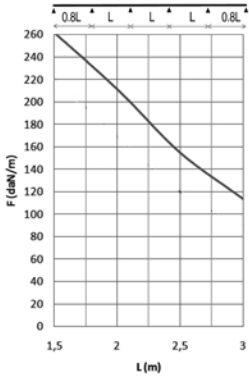

KG110S

KG with SIN

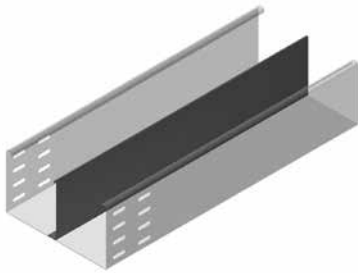

Not perforated
Return flanges

To order	Height 85 mm
Standard finish	Pre-galvanised
Optional finish HD	Hot-dip galvanised
Optional finish PE	Coating

HD	Reference	↑ mm	↔ mm	↔ mm	↔ mm	kg/m	⊞	Stock	Unit
HD	KG110.100.150S12	110	100	1.50	3000	4.820	30		m
HD	KG110.100.150S13	110	100	1.50	3000	4.820	30		m
HD	KG110.100.150S23	110	100	1.50	3000	5.640	30		m
HD	KG110.150.150S12	110	150	1.50	3000	5.410	30		m
HD	KG110.150.150S13	110	150	1.50	3000	5.410	30		m
HD	KG110.150.150S23	110	150	1.50	3000	6.230	30		m
HD	KG110.200.150S12	110	200	1.50	3000	6.000	30		m
HD	KG110.200.150S13	110	200	1.50	3000	6.000	30		m
HD	KG110.200.150S23	110	200	1.50	3000	6.820	30		m
HD	KG110.300.150S12	110	300	1.50	3000	7.180	30		m
HD	KG110.300.150S13	110	300	1.50	3000	7.180	30		m
HD	KG110.300.150S23	110	300	1.50	3000	8.000	30		m
HD	KG110.400.150S12	110	400	1.50	3000	8.360	30		m
HD	KG110.400.150S13	110	400	1.50	3000	8.360	30		m
HD	KG110.400.150S23	110	400	1.50	3000	9.180	30		m
HD	KG110.500.150S12	110	500	1.50	3000	9.530	30		m
HD	KG110.500.150S13	110	500	1.50	3000	9.530	30		m
HD	KG110.500.150S23	110	500	1.50	3000	10.350	30		m
HD	KG110.600.150S12	110	600	1.50	3000	10.710	30		m
HD	KG110.600.150S13	110	600	1.50	3000	10.710	30		m
HD	KG110.600.150S23	110	600	1.50	3000	11.530	30		m

Fix with:									
HD	V110.200	100	200	-	-	0.170	48	✓	piece
HD	VM6.10	-	-	M6	10	0.008	100	✓	piece

LOAD DIAGRAM

This diagram illustrates the permissible uniformly distributed loads applied to multiple supports. They comply with IEC 61537 with connection in the centre of the span and the end span = 0,8x the span.

F = max. admissible load (daN/m)

L = support distance (m)

Max. deflection (m) = L/100

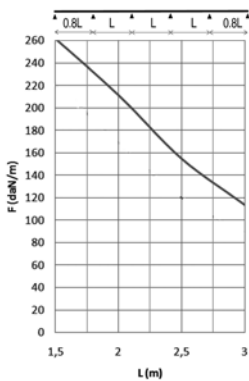

S12: one partition in the middle of the cable tray

S13: one partition at right or the left of the cable tray

S23: two partitions

NATO15

Perforated cable tray - upright flanges

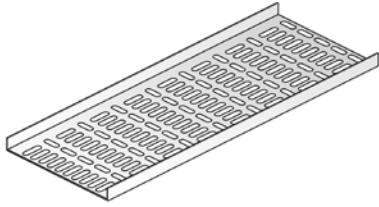

Linear and alternative perforations
Upright flanges

Standard finish	Pre-galvanised
Optional finish HD	Hot-dip galvanised
Optional finish PE	Coating

HD	Reference	↑ mm	↔ mm	↔ mm	↔ mm	kg/m	⊞	Stock	Unit
HD	NATO15.050.125	15	50	1.25	2000	0.730	40	✓	m
HD	NATO15.100.125	15	100	1.25	2000	1.050	20	✓	m
HD	NATO15.150.125	15	150	1.25	2000	1.350	20	✓	m
HD	NATO15.200.125	15	200	1.25	2000	1.700	20	✓	m
HD	NATO15.300.125	15	300	1.25	2000	2.400	20	✓	m

Fix with:

HD	V15.200	20	150	-	-	0.050	48	✓	piece
----	---------	----	-----	---	---	-------	----	---	-------

LOAD DIAGRAM

Mounted in continuous span with the joining plates 1/5 away from the supports. Safety factor = 2.

F = max. admissible load (daN/m)

L = support distance (m)

L/200 = deflection (m)

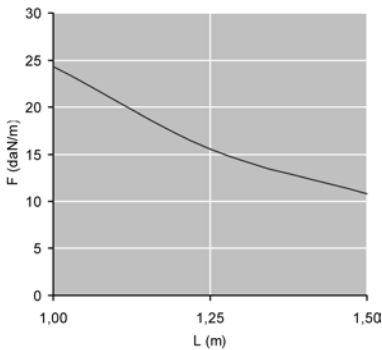

D

Universal cover

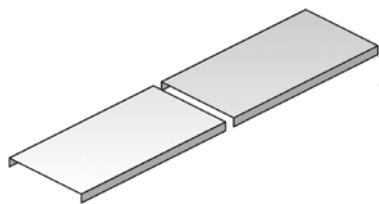

Especially used for horizontal and vertical sections

Standard finish	Pre-galvanised
Optional finish HD	Hot-dip galvanised
Optional finish PE	Coating

HD	Reference	↑ mm	↔ mm	↔ mm	↔ mm	kg/m	⊞	Stock	Unit
HD	D050	10	50	0.75	3000	0.350	3	✓	m
HD	D075	10	75	0.75	2000	0.500	20	✓	m
HD	D100	10	100	0.75	2000	0.820	20	✓	m
HD	D150	10	150	0.75	2000	1.170	20	✓	m
HD	D200	10	200	0.75	2000	1.420	20	✓	m
HD	D250	10	250	0.75	2000	1.850	20	✓	m
HD	D300	10	300	1.00	2000	2.100	20	✓	m
HD	D400	10	400	1.25	2000	4.150	20	✓	m
HD	D500	10	500	1.25	2000	5.000	2	✓	m
HD	D600	10	600	1.25	2000	5.650	2	✓	m

Fix with:

-	DCO	-	-	-	-	0.010	100	✓	piece
-	DCL	-	-	-	-	0.005	100	✓	piece

Covers with width > 400 mm are delivered with diagonal reinforcements.

DZ

Cover with swivel clamp

For cable tray KBSI, KBS, KBSM(I), KGI and KG.

Standard finish

Pre-galvanised



HD	Reference	↑ mm	↔ mm	↔ mm	↔ mm	kg/m	📦	Stock	Unit
-	DZ050	10	50	1.00	3000	0.430	30	✓	m
-	DZ075	10	75	1.00	3000	0.580	30	✓	m
-	DZ100	10	100	1.00	3000	0.900	30	✓	m
-	DZ150	10	150	1.00	3000	1.250	30	✓	m
-	DZ200	10	200	1.00	3000	1.500	30	✓	m
-	DZ300	10	300	1.00	3000	2.200	30	✓	m

The technical information for this product can be found at the end of this chapter.

With integrated clamps DZK.

6 DZK per length.

DZ050 and DZ075: 5 DZK.

To order per 2 pieces.

DCO

Cover clamp

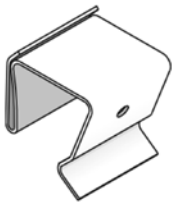

Number: 2 pieces per meter.

Standard finish

Stainless Steel

HD	Reference	↑ mm	↔ mm	↔ mm	↔ mm	kg/piece	📦	Stock	Unit
-	DCO	-				0.010	100	✓	piece

To order per full packaging.

DCL

Cover clamp clips

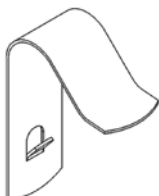

Number: 2 pieces per meter.

Not applicable for KG.

Standard finish

Stainless Steel

HD	Reference	↑ mm	↔ mm	↔ mm	↔ mm	kg/piece	📦	Stock	Unit
-	DCL	-				0.005	100	✓	piece

To order per full packaging.

DZK

Swivel clamp



Standard finish

Electro zinc-plated

HD	Reference	↑ mm	↔ mm	↔ mm	↔ mm	kg/piece	⊞	Stock	Unit
-	DZK	-				0.013	25	✓	piece

To order per full packaging.
Included: Bolt RBKR6.12 and nut ZDM6.

B90

Horizontal bend 90°

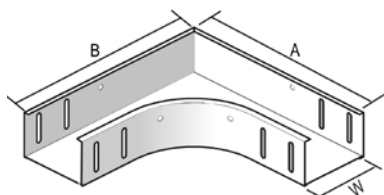

Slides over the cable trays

Radius	100 mm
To order	Height 35mm - 85mm - 110mm
Standard finish	Pre-galvanised
Optional finish HD	Hot-dip galvanised
Optional finish PE	Coating

	50	75	100	150	200	250	300	400	500	600
A	255	280	305	355	405	455	505	605	705	805
B	255	280	305	355	405	455	505	605	705	805

HD	Reference	↑ mm	↔ mm	↔ mm	↔ mm	kg/piece	⊞	Stock	Unit
HD	B90.60.050	60	50		-	0.474	1	✓	piece
HD	B90.60.075	60	75		-	0.516	1	✓	piece
HD	B90.60.100	60	100		-	0.738	1	✓	piece
HD	B90.60.150	60	150		-	0.822	1	✓	piece
HD	B90.60.200	60	200		-	1.374	1	✓	piece
HD	B90.60.250	60	250		-	1.858	1	✓	piece
HD	B90.60.300	60	300		-	2.292	1	✓	piece
HD	B90.60.400	60	400		-	2.958	1	✓	piece
HD	B90.60.500	60	500		-	5.424	1	✓	piece
HD	B90.60.600	60	600		-	6.690	1	✓	piece

Fix with:

HD	VM6.10	-	-	M6	10	0.008	100	✓	piece
HD	VMK6.10	-	-	M6	-	0.009	100	✓	piece
HD	VMK12.20	-	-	M12	-	0.073	100	✓	piece

The technical information for this product can be found at the end of this chapter.

Minimum number bolts and nuts: 8 pieces.

DB90

Cover for horizontal bend 90°

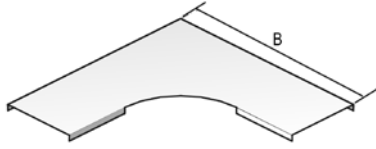

Standard finish	Pre-galvanised
Optional finish HD	Hot-dip galvanised
Optional finish PE	Coating

	50	75	100	150	200	250	300	400	500	600
B	256	281	306	356	406	456	506	606	706	806

HD	Reference	↑ mm	↔ mm	↔ mm	↔ mm	kg/piece	⊞	Stock	Unit
HD	DB90.050	10	56		-	0.567	1	✓	piece
HD	DB90.075	10	81		-	0.617	1	✓	piece
HD	DB90.100	10	106		-	0.728	1	✓	piece
HD	DB90.150	10	156		-	1.074	1	✓	piece
HD	DB90.200	10	206		-	1.262	1	✓	piece
HD	DB90.250	10	256		-	1.741	1	✓	piece
HD	DB90.300	10	306		-	1.941	1	✓	piece
HD	DB90.400	10	406		-	3.043	1	✓	piece
HD	DB90.500	10	506		-	4.111	1	✓	piece
HD	DB90.600	10	606		-	5.340	1	✓	piece
Fix with:									
-	DCL	-	-	-	-	0.005	100	✓	piece

VH

Adjustable Corner

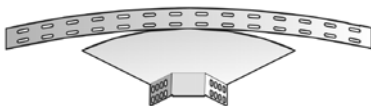

Corner plate adjustable between 90° and 180°

To order	Height 35 mm - 85 mm - 110 mm
Standard finish	Pre-galvanised
Optional finish HD	Hot-dip galvanised
Optional finish PE	Coating

HD	Reference	↑ mm	↔ mm	↔ mm	↔ mm	kg/piece	⊞	Stock	Unit
HD	VH60.050	60	50		-	0.448	1		piece
HD	VH60.075	60	75		-	0.486	1	✓	piece
HD	VH60.100	60	100		-	0.533	1	✓	piece
HD	VH60.150	60	150		-	0.659	1	✓	piece
HD	VH60.200	60	200		-	0.824	1	✓	piece
HD	VH60.250	60	250		-	1.144	1	✓	piece
HD	VH60.300	60	300		-	1.385	1	✓	piece
HD	VH60.400	60	400		-	2.042	1	✓	piece
HD	VH60.500	60	500		-	2.913	1	✓	piece
HD	VH60.600	60	600		-	3.938	1	✓	piece
Fix with:									
HD	VM6.10	-	-	M6	10	0.008	100	✓	piece
HD	VMK6.10	-	-	M6	-	0.009	100	✓	piece
HD	VMK12.20	-	-	M12	-	0.073	100	✓	piece

Minimum number bolts and nuts: 4 pieces.

T

Horizontal T-piece

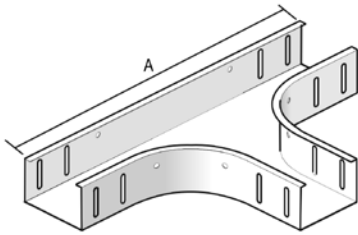

Slides over the cable trays

Radius	100 mm
To order	Height 35 mm - 85 mm - 110 mm
Standard finish	Pre-galvanised
Optional finish HD	Hot-dip galvanised
Optional finish PE	Coating

	50	75	100	150	200	250	300	400	500	600
A	458	483	508	558	608	658	708	808	908	1008

HD	Reference	↑ mm	↔ mm	↔ mm	↔ mm	kg/piece	⊞	Stock	Unit
HD	T60.050	60	50		-	0.832	1	✓	piece
HD	T60.075	60	75		-	0.978	1	✓	piece
HD	T60.100	60	100		-	1.124	1	✓	piece
HD	T60.150	60	150		-	1.516	1	✓	piece
HD	T60.200	60	200		-	1.758	1	✓	piece
HD	T60.250	60	250		-	2.250	1	✓	piece
HD	T60.300	60	300		-	2.590	1	✓	piece
HD	T60.400	60	400		-	3.380	1	✓	piece
HD	T60.500	60	500		-	6.120	1	✓	piece
HD	T60.600	60	600		-	7.260	1	✓	piece

Fix with:

HD	VM6.10	-	-	M6	10	0.008	100	✓	piece
HD	VMK6.10	-	-	M6	-	0.009	100	✓	piece
HD	VMK12.20	-	-	M12	-	0.073	100	✓	piece

Minimum number bolts and nuts: 12 pieces.

DT

Cover for horizontal T-piece

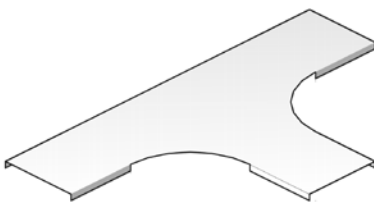

For all heights

Standard finish	Pre-galvanised
Optional finish HD	Hot-dip galvanised
Optional finish PE	Coating

HD	Reference	↑ mm	↔ mm	↔ mm	↔ mm	kg/piece	⊞	Stock	Unit
HD	DT050	10	56		-	0.977	1	✓	piece
HD	DT075	10	81		-	1.127	1	✓	piece
HD	DT100	10	106		-	1.287	1	✓	piece
HD	DT150	10	156		-	1.638	1	✓	piece
HD	DT200	10	206		-	2.028	1	✓	piece
HD	DT250	10	256		-	1.660	1	✓	piece
HD	DT300	10	306		-	2.930	1	✓	piece
HD	DT400	10	406		-	3.991	1	✓	piece
HD	DT500	10	506		-	5.213	1	✓	piece
HD	DT600	10	606		-	5.290	1	✓	piece

Fix with:

-	DCL	-	-	-	-	0.005	100	✓	piece
---	-----	---	---	---	---	-------	-----	---	-------

AS

Horizontal adapter 90°

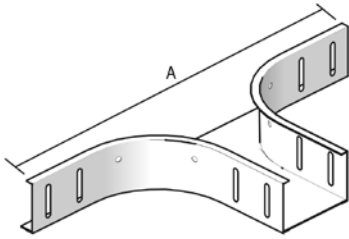

Slides over the cable trays

Radius	100 mm
To order	Height 35 mm - 85 mm - 110 mm
Standard finish	Pre-galvanised
Optional finish HD	Hot-dip galvanised
Optional finish PE	Coating

	50	75	100	150	200	250	300	400	500	600
A	458	483	508	558	608	658	708	808	908	1008

HD	Reference	↑ mm	↔ mm	↔ mm	↔ mm	kg/piece	⊞	Stock	Unit
HD	AS60.050	60	50		-	0.490	1	✓	piece
HD	AS60.075	60	75		-	0.530	1	✓	piece
HD	AS60.100	60	100		-	0.570	1	✓	piece
HD	AS60.150	60	150		-	0.650	1	✓	piece
HD	AS60.200	60	200		-	0.730	1	✓	piece
HD	AS60.250	60	250		-	0.800	1	✓	piece
HD	AS60.300	60	300		-	0.880	1	✓	piece
HD	AS60.400	60	400		-	0.103	1	✓	piece
HD	AS60.500	60	500		-	1.524	1	✓	piece
HD	AS60.600	60	600		-	1.740	1	✓	piece

Fix with:

HD	Reference	↑ mm	↔ mm	↔ mm	↔ mm	kg/piece	⊞	Stock	Unit
HD	VM6.10	-	-	M6	10	0.008	100	✓	piece
HD	VMK6.10	-	-	M6	-	0.009	100	✓	piece
HD	VMK12.20	-	-	M12	-	0.073	100	✓	piece

Minimum number bolts and nuts: 8 pieces.

DAS

Cover for horizontal adapter 90°

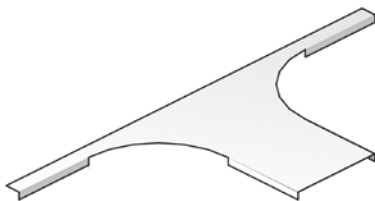

For all heights

Standard finish	Pre-galvanised
Optional finish HD	Hot-dip galvanised
Optional finish PE	Coating

HD	Reference	↑ mm	↔ mm	↔ mm	↔ mm	kg/piece	⊞	Stock	Unit
HD	DAS050	10	56		-	0.161	1	✓	piece
HD	DAS075	10	81		-	0.242	1	✓	piece
HD	DAS100	10	106		-	0.323	1	✓	piece
HD	DAS150	10	156		-	0.484	1	✓	piece
HD	DAS200	10	206		-	0.645	1	✓	piece
HD	DAS250	10	256		-	0.510	1	✓	piece
HD	DAS300	10	306		-	0.967	1	✓	piece
HD	DAS400	10	406		-	1.290	1	✓	piece
HD	DAS500	10	506		-	1.612	1	✓	piece
HD	DAS600	10	606		-	1.935	1	✓	piece

Fix with:

-	DCL	-	-	-	-	0.005	100	✓	piece
---	-----	---	---	---	---	-------	-----	---	-------

KR

Cross-over

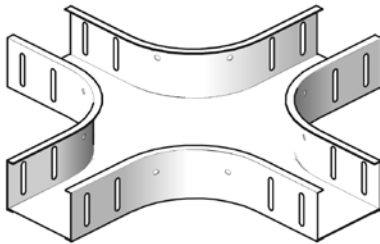

Slides over the cable trays

Radius	100 mm
To order	Height 35 mm - 85 mm - 110 mm
Standard finish	Pre-galvanised
Optional finish HD	Hot-dip galvanised
Optional finish PE	Coating

HD	Reference	↑ mm	↔ mm	↔ mm	↔ mm	kg/piece	⊞	Stock	Unit
HD	KR60.050	60	50		-	1.180	1	✓	piece
HD	KR60.075	60	75		-	1.560	1	✓	piece
HD	KR60.100	60	100		-	1.480	1	✓	piece
HD	KR60.150	60	150		-	2.080	1	✓	piece
HD	KR60.200	60	200		-	2.380	1	✓	piece
HD	KR60.250	60	250		-	2.760	1	✓	piece
HD	KR60.300	60	300		-	3.520	1	✓	piece
HD	KR60.400	60	400		-	4.610	1	✓	piece
HD	KR60.500	60	500		-	5.320	1	✓	piece
HD	KR60.600	60	600		-	6.160	1	✓	piece

Fix with:

HD	Reference	↑ mm	↔ mm	↔ mm	↔ mm	kg/piece	⊞	Stock	Unit
HD	VM6.10	-	-	M6	10	0.008	100	✓	piece
HD	VMK6.10	-	-	M6	-	0.009	100	✓	piece
HD	VMK12.20	-	-	M12	-	0.073	100	✓	piece

Minimum number bolts and nuts: 16 pieces.

DKR

Cover for cross-over

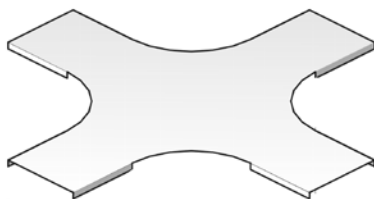

For all heights

Standard finish	Pre-galvanised
Optional finish HD	Hot-dip galvanised
Optional finish PE	Coating

HD	Reference	↑ mm	↔ mm	↔ mm	↔ mm	kg/piece	⊞	Stock	Unit
HD	DKR050	10	56		-	0.460	1	✓	piece
HD	DKR075	10	81		-	0.630	1	✓	piece
HD	DKR100	10	106		-	0.800	1	✓	piece
HD	DKR150	10	156		-	1.180	1	✓	piece
HD	DKR200	10	206		-	1.590	1	✓	piece
HD	DKR250	10	256		-	2.040	1	✓	piece
HD	DKR300	10	306		-	2.520	1	✓	piece
HD	DKR400	10	406		-	3.590	1	✓	piece
HD	DKR500	10	506		-	6.658	1	✓	piece
HD	DKR600	10	606		-	8.545	1	✓	piece

Fix with:

-	DCL	-	-	-	-	0.005	100	✓	piece
---	-----	---	---	---	---	-------	-----	---	-------

SB90

Rising elbow 90°

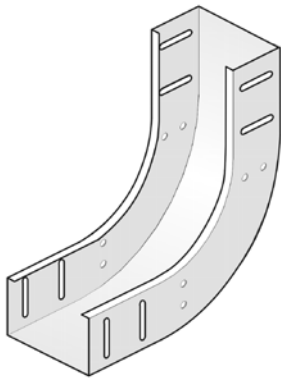

Slides over the cable trays

Radius	100 mm
To order	Height 35 mm - 85 mm - 110 mm
Standard finish	Pre-galvanised
Optional finish HD	Hot-dip galvanised
Optional finish PE	Coating

HD	Reference	↑ mm	↔ mm	↗ mm	↘ mm	kg/piece	📦	Stock	Unit
HD	SB90.60.050	60	50		-	0.550	1	✓	piece
HD	SB90.60.075	60	75		-	0.650	1	✓	piece
HD	SB90.60.100	60	100		-	0.730	1	✓	piece
HD	SB90.60.150	60	150		-	0.880	1	✓	piece
HD	SB90.60.200	60	200		-	1.000	1	✓	piece
HD	SB90.60.250	60	250		-	1.080	1	✓	piece
HD	SB90.60.300	60	300		-	1.180	1	✓	piece
HD	SB90.60.400	60	400		-	1.430	1	✓	piece
HD	SB90.60.500	60	500		-	1.900	1	✓	piece
HD	SB90.60.600	60	600		-	2.150	1	✓	piece

Fix with:									
HD	VM6.10	-	-	M6	10	0.008	100	✓	piece
HD	VMK6.10	-	-	M6	-	0.009	100	✓	piece
HD	VMK12.20	-	-	M12	-	0.073	100	✓	piece

Minimum number bolts and nuts: 8 pieces.

SBCL

Snap-in rising elbow 90°

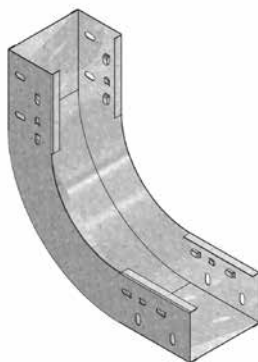

Snap-in system with cable tray KBS60 and KBSI60

Radius	100 mm
Standard finish	Pre-galvanised
Optional finish PE	Coating

HD	Reference	↑ mm	↔ mm	↗ mm	↘ mm	kg/piece	📦	Stock	Unit
-	SBCL90.60.050	60	50		-	0.550	1	✓	piece
-	SBCL90.60.075	60	75		-	0.650	1		piece
-	SBCL90.60.100	60	100		-	0.730	1	✓	piece
-	SBCL90.60.150	60	150		-	0.880	1	✓	piece
-	SBCL90.60.200	60	200		-	1.000	1	✓	piece
-	SBCL90.60.250	60	250		-	1.080	1	✓	piece
-	SBCL90.60.300	60	300		-	1.180	1	✓	piece
-	SBCL90.60.400	60	400		-	1.430	1	✓	piece
-	SBCL90.60.500	60	500		-	1.900	1	✓	piece
-	SBCL90.60.600	60	600		-	2.150	1	✓	piece

Opening for extra locking using 4x VM6.10.
 Openings provided for fitting a cover.
 Only available in height 60 mm.

DSB90

Cover for rising elbow 90°

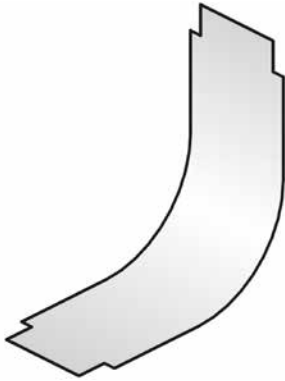

Flat bended

Standard finish

Pre-galvanised

Optional finish HD

Hot-dip galvanised

Optional finish PE

Coating

HD	Reference	↑ mm	↔ mm	↔ mm	↔ mm	kg/piece	⊞	Stock	Unit
HD	DSB90.050	-	50		-	0.131	1	✓	piece
HD	DSB90.075	-	75		-	0.197	1	✓	piece
HD	DSB90.100	-	100		-	0.262	1	✓	piece
HD	DSB90.150	-	150		-	0.393	1	✓	piece
HD	DSB90.200	-	200		-	0.524	1	✓	piece
HD	DSB90.250	-	250		-	0.655	1	✓	piece
HD	DSB90.300	-	300		-	0.786	1	✓	piece
HD	DSB90.400	-	400		-	1.048	1	✓	piece
HD	DSB90.500	-	500		-	1.310	1	✓	piece
HD	DSB90.600	-	600		-	1.572	1	✓	piece
Fix with:									
-	DCL	-	-	-	-	0.005	100	✓	piece

VB90

Low elbow 90°

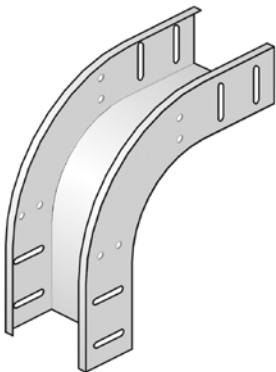

Slides over the cable trays

Radius

100 mm

To order

Height 35 mm - 85 mm - 110 mm

Standard finish

Pre-galvanised

Optional finish HD

Hot-dip galvanised

Optional finish PE

Coating

HD	Reference	↑ mm	↔ mm	↔ mm	↔ mm	kg/piece	⊞	Stock	Unit
HD	VB90.60.050	60	50		-	0.550	1	✓	piece
HD	VB90.60.075	60	75		-	0.630	1	✓	piece
HD	VB90.60.100	60	100		-	0.650	1	✓	piece
HD	VB90.60.150	60	150		-	0.780	1	✓	piece
HD	VB90.60.200	60	200		-	0.850	1	✓	piece
HD	VB90.60.250	60	250		-	0.950	1	✓	piece
HD	VB90.60.300	60	300		-	1.080	1	✓	piece
HD	VB90.60.400	60	400		-	1.330	1	✓	piece
HD	VB90.60.500	60	500		-	1.430	1	✓	piece
HD	VB90.60.600	60	600		-	1.600	1	✓	piece
Fix with:									
HD	VM6.10	-	-	M6	10	0.008	100	✓	piece
HD	VMK6.10	-	-	M6	-	0.009	100	✓	piece
HD	VMK12.20	-	-	M12	-	0.073	100	✓	piece

Minimum number bolts and nuts: 8 pieces.

VBCL

Snap-in low elbow 90°

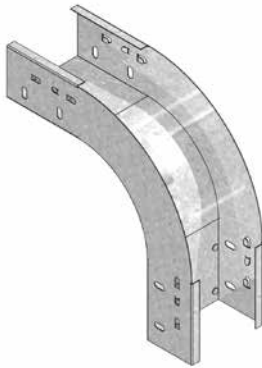

Snap-in system with cable tray KBS60 and KBSI60

Radius	100 mm
Standard finish	Pre-galvanised
Optional finish PE	Coating

HD	Reference	↑ mm	↔ mm	↔ mm	↔ mm	kg/piece	⊞	Stock	Unit
-	VBCL90.60.050	60	50		-	0.550	1	✓	piece
-	VBCL90.60.075	60	75		-	0.630	1	✓	piece
-	VBCL90.60.100	60	100		-	0.650	1	✓	piece
-	VBCL90.60.150	60	150		-	0.780	1	✓	piece
-	VBCL90.60.200	60	200		-	0.850	1	✓	piece
-	VBCL90.60.250	60	250		-	0.950	1	✓	piece
-	VBCL90.60.300	60	300		-	1.080	1	✓	piece
-	VBCL90.60.400	60	400		-	1.330	1	✓	piece
-	VBCL90.60.500	60	500		-	1.430	1	✓	piece
-	VBCL90.60.600	60	600		-	1.600	1	✓	piece

Opening for extra locking using 4x VM6.10.
 Openings provided for fitting a cover.
 Only available in height 60 mm.

DVB90

Cover for low elbow 90°

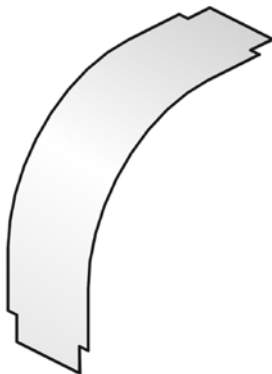

Flat bended

To order	Height of 35 mm - 85 mm - 110 mm
Standard finish	Pre-galvanised
Optional finish HD	Hot-dip galvanised
Optional finish PE	Coating

HD	Reference	↑ mm	↔ mm	↔ mm	↔ mm	kg/piece	⊞	Stock	Unit
HD	DVB90.60.050	-	50		-	0.150	1	✓	piece
HD	DVB90.60.075	-	75		-	0.242	1	✓	piece
HD	DVB90.60.100	-	100		-	0.323	1	✓	piece
HD	DVB90.60.150	-	150		-	0.484	1	✓	piece
HD	DVB90.60.200	-	200		-	0.645	1	✓	piece
HD	DVB90.60.250	-	250		-	0.806	1	✓	piece
HD	DVB90.60.300	-	300		-	0.967	1	✓	piece
HD	DVB90.60.400	-	400		-	1.290	1	✓	piece
HD	DVB90.60.500	-	500		-	1.612	1	✓	piece
HD	DVB90.60.600	-	600		-	1.935	1	✓	piece

Fix with:									
-	DCL	-	-	-	-	0.005	100	✓	piece

SDB

Hinged joiner double

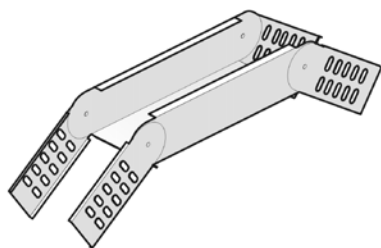

To order	Height 35 mm - 85 mm - 110 mm
Standard finish	Pre-galvanised
Optional finish HD	Hot-dip galvanised
Optional finish PE	Coating

HD	Reference	↑ mm	↔ mm	↔ mm	↔ mm	kg/piece	⊞	Stock	Unit
HD	SDB60.050	60	50		-	0.700	1		piece
HD	SDB60.075	60	75		-	0.740	1		piece
HD	SDB60.100	60	100		-	0.790	1		piece
HD	SDB60.150	60	150		-	0.880	1		piece
HD	SDB60.200	60	200		-	0.970	1		piece
HD	SDB60.250	60	250		-	1.060	1		piece
HD	SDB60.300	60	300		-	1.150	1		piece
HD	SDB60.400	60	400		-	1.330	1		piece
HD	SDB60.500	60	500		-	1.510	1		piece
HD	SDB60.600	60	600		-	1.670	1		piece

Fix with:									
HD	VM6.10	-	-	M6	10	0.008	100	✓	piece
HD	VMK6.10	-	-	M6	-	0.009	100	✓	piece
HD	VMK12.20	-	-	M12	-	0.073	100	✓	piece

Minimum number bolts and nuts: 8 pieces.

DS

Hinged joiner

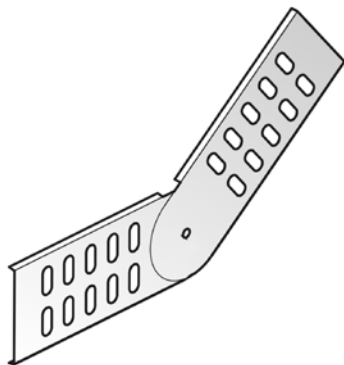

Standard finish	Pre-galvanised
Optional finish HD	Hot-dip galvanised
Optional finish PE	Coating

HD	Reference	↑ mm	↔ mm	↔ mm	↔ mm	kg/piece	⊞	Stock	Unit
HD	DS35	35			-	0.110	48		piece
HD	DS60	60			-	0.130	50	✓	piece
HD	DS85	85			-	0.340	24		piece
HD	DS110	110			-	0.390	24		piece

Fix with:									
HD	VM6.10	-	-	M6	10	0.008	100	✓	piece
HD	VMK6.10	-	-	M6	-	0.009	100	✓	piece
HD	VMK12.20	-	-	M12	-	0.073	100	✓	piece

To order per full packaging.
Minimum number bolts and nuts: 4 pieces.

AZH

Universal coupling 90°

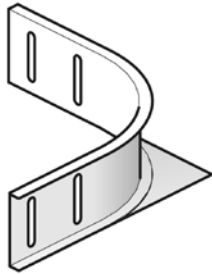

Standard finish	Pre-galvanised
Optional finish HD	Hot-dip galvanised
Optional finish PE	Coating

HD	Reference	↑ mm	↔ mm	↔ mm	↔ mm	kg/piece	📦	Stock	Unit
HD	AZH35	35				0.340	1		piece
HD	AZH60	60				0.390	1	✓	piece
HD	AZH85	85				0.750	1		piece
HD	AZH110	110				0.900	1		piece

Fix with:									
HD	VM6.10	-	-	M6	10	0.008	100	✓	piece
HD	VMK6.10	-	-	M6	-	0.009	100	✓	piece
HD	VMK12.20	-	-	M12	-	0.073	100	✓	piece

The technical information for this product can be found at the end of this chapter.

Minimum number bolts and nuts: 4 pieces.

BVSI

Stiffening plate

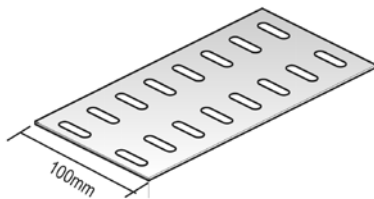

Standard finish	Pre-galvanised
Optional finish HD	Hot-dip galvanised
Optional finish PE	Coating

HD	Reference	↑ mm	↔ mm	↔ mm	↔ mm	kg/piece	📦	Stock	Unit
HD	BVSI050	-	46		100	0.047	1	✓	piece
HD	BVSI075	-	70		100	0.071	1	✓	piece
HD	BVSI100	-	75		100	0.077	1	✓	piece
HD	BVSI150	-	125		100	0.128	1	✓	piece
HD	BVSI200	-	175		100	0.179	1	✓	piece
HD	BVSI250	-	225		100	0.230	1	✓	piece
HD	BVSI300	-	275		100	0.281	1	✓	piece
HD	BVSI400	-	375		100	0.383	1	✓	piece
HD	BVSI500	-	475		100	0.486	1	✓	piece
HD	BVSI600	-	575		100	0.588	1	✓	piece

Fix with:									
HD	VM6.10	-	-	M6	10	0.008	100	✓	piece
HD	VMK6.10	-	-	M6	-	0.009	100	✓	piece
HD	VMK12.20	-	-	M12	-	0.073	100	✓	piece

Minimum number bolts and nuts: 4 pieces.

VS

Reducing plate

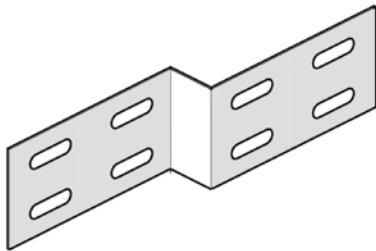

To order	Height 35 mm - 85 mm - 110 mm
Standard finish	Pre-galvanised
Optional finish HD	Hot-dip galvanised
Optional finish PE	Coating

HD	Reference	↑ mm	↔ mm	↔ mm	↔ mm	kg/piece	⊞	Stock	Unit
HD	VS60.025	50	25		-	0.080	1	✓	piece
HD	VS60.050	50	50		-	0.080	1	✓	piece
HD	VS60.075	50	75		-	0.090	1	✓	piece
HD	VS60.100	50	100		-	0.100	1	✓	piece
HD	VS60.125	50	125		-	0.100	1	✓	piece
HD	VS60.150	50	150		-	0.110	1	✓	piece
HD	VS60.200	50	200		-	0.120	1	✓	piece
HD	VS60.250	50	250		-	0.140	1	✓	piece
HD	VS60.300	50	300		-	0.180	1	✓	piece
HD	VS60.350	50	350		-	0.180	1	✓	piece
HD	VS60.400	50	400		-	0.210	1	✓	piece

Fix with:

HD	VM6.10	-	-	M6	10	0.008	100	✓	piece
HD	VMK6.10	-	-	M6	-	0.009	100	✓	piece
HD	VMK12.20	-	-	M12	-	0.073	100	✓	piece

The technical information for this product can be found at the end of this chapter.

Minimum number bolts and nuts: 4 pieces.

E

End piece

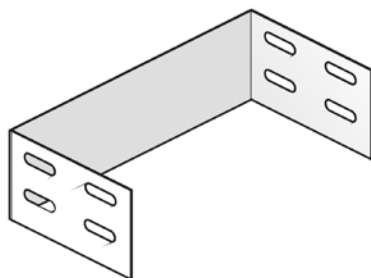

To order	Height 35 mm - 85 mm - 110 mm
Standard finish	Pre-galvanised
Optional finish HD	Hot-dip galvanised
Optional finish PE	Coating

HD	Reference	↑ mm	↔ mm	↔ mm	↔ mm	kg/piece	⊞	Stock	Unit
HD	E60.050	55	46		-	0.107	1	✓	piece
HD	E60.075	55	71		-	0.118	1	✓	piece
HD	E60.100	55	96		-	0.129	1	✓	piece
HD	E60.150	55	146		-	0.151	1	✓	piece
HD	E60.200	55	196		-	0.173	1	✓	piece
HD	E60.250	55	246		-	0.160	1	✓	piece
HD	E60.300	55	296		-	0.217	1	✓	piece
HD	E60.400	55	396		-	0.261	1	✓	piece
HD	E60.500	55	496		-	0.305	1	✓	piece
HD	E60.600	55	596		-	0.349	1	✓	piece

Fix with:

HD	VM6.10	-	-	M6	10	0.008	100	✓	piece
HD	VMK6.10	-	-	M6	-	0.009	100	✓	piece
HD	VMK12.20	-	-	M12	-	0.073	100	✓	piece

Minimum number bolts and nuts: 4 pieces.

RBKBSM

Edge protection KBSM(I)



To be used with KBSM(I)60

Standard finish

Polypropylene

HD	Reference	↑ mm	↔ mm	↔ mm	↔ mm	kg/piece	📦	Stock	Unit
-	RBKBSM	37	57			0.004	25	✓	piece

To order per full packaging.

MP

Folded mounting plate

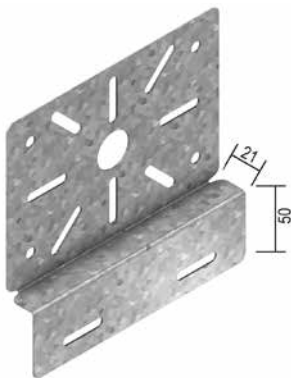

For fixing of contact and distribution boxes

Standard finish

Pre-galvanised

Optional finish HD

Hot-dip galvanised

Optional finish PE

Coating

HD	Reference	↑ mm	↔ mm	↔ mm	↔ mm	kg/piece	📦	Stock	Unit
HD	MP	157	160			0.180	50	✓	piece

Fix with:

HD	VM6.10	-	-	M6	10	0.008	100	✓	piece
HD	VMK6.10	-	-	M6	-	0.009	100	✓	piece
HD	VMK12.20	-	-	M12	-	0.073	100	✓	piece

To order per full packaging.
Number bolts and nuts: 2 pieces.

MPV

Flat mounting plate

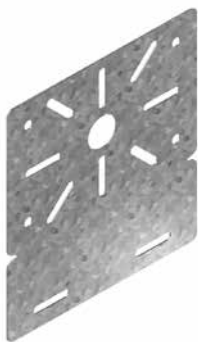

For fixing of contact and distribution boxes

Standard finish

Pre-galvanised

Optional finish HD

Hot-dip galvanised

Optional finish PE

Coating

HD	Reference	↑ mm	↔ mm	↔ mm	↔ mm	kg/piece	📦	Stock	Unit
HD	MPV	175	160			0.200	50	✓	piece

Fix with:

HD	VM6.10	-	-	M6	10	0.008	100	✓	piece
HD	VMK6.10	-	-	M6	-	0.009	100	✓	piece
HD	VMK12.20	-	-	M12	-	0.073	100	✓	piece
-	KBV	-	-	-	-	0.001	100	✓	piece

To order per full packaging.
Number bolts and nuts: 2 pieces.

MPVCL

Snap-in mounting plate

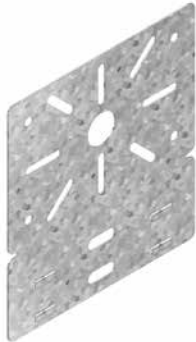

For fixing of contact and distribution boxes.

Standard finish Pre-galvanised

Optional finish PE Coating

HD	Reference	↑ mm	↔ mm	↔ mm	↔ mm	kg/piece	📦	Stock	Unit
-	MPVCL	175	160			0.180	50	✓	piece
Fix with:									
-	KBV	-	-	-	-	0.001	100	✓	piece

To order per full packaging.

SLOS

Bolt-in partition

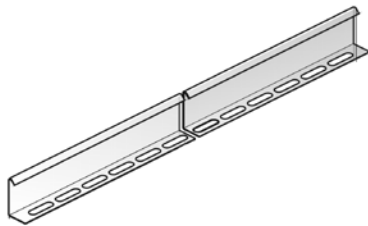

Standard finish Pre-galvanised

Optional finish HD Hot-dip galvanised

Optional finish PE Coating

HD	Reference	↑ mm	↔ mm	↔ mm	↔ mm	kg/m	📦	Stock	Unit
HD	SLOS35	35			3000	0.330	150	✓	m
HD	SLOS60	60			3000	0.511	120	✓	m
HD	SLOS85	85			3000	0.680	60	✓	m
HD	SLOS110	110			3000	0.820	30	✓	m
Fix with:									
HD	VM6.10	-	-	M6	10	0.008	100	✓	piece
HD	VMK6.10	-	-	M6	-	0.009	100	✓	piece
HD	VMK12.20	-	-	M12	-	0.073	100	✓	piece

Fixing set: 1 per meter.

SLIS

Snap-in partition

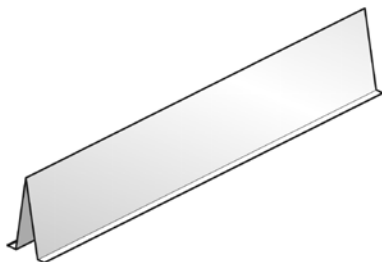

Standard finish Pre-galvanised

HD	Reference	↑ mm	↔ mm	↔ mm	↔ mm	kg/m	📦	Stock	Unit
-	SLIS60	60			3000	0.440	3	✓	m

Fixing set clips CL: 4 pieces per length.
Can be used on any width from 75 mm and up.

CL

Clips for SLIS

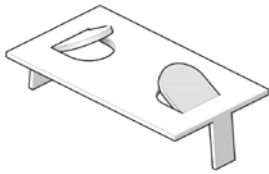

Standard finish

Pre-galvanised

HD	Reference	↑ mm	↔ mm	↔ mm	↔ mm	kg/piece	📦	Stock	Unit
-	CL	-				0.005	100	✓	piece

To order per full packaging.

V15.200

Joining plate

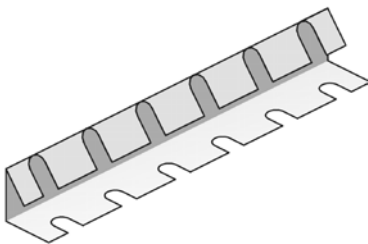

Standard finish

Pre-galvanised

Optional finish HD

Hot-dip galvanised

Optional finish PE

Coating

HD	Reference	↑ mm	↔ mm	↔ mm	↔ mm	kg/piece	📦	Stock	Unit
HD	V15.200	20	150			0.050	48	✓	piece

To order per full packaging.

V35

Joiner for fast mounting

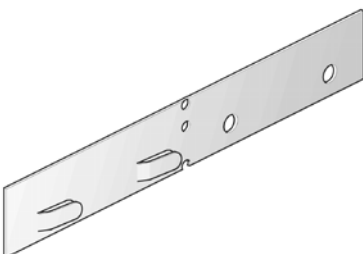

Standard finish

Pre-galvanised

Optional finish PE

Coating

HD	Reference	↑ mm	↔ mm	↔ mm	↔ mm	kg/piece	📦	Stock	Unit
-	V35	27	180			0.050	48	✓	piece

Fix with:

HD	VM6.10	-	-	M6	10	0.008	100	✓	piece
----	---------------	---	---	----	----	-------	-----	---	-------

To order per full packaging.
Minimum number bolts and nuts: 1 pieces.

V60

Joiner for fast mounting

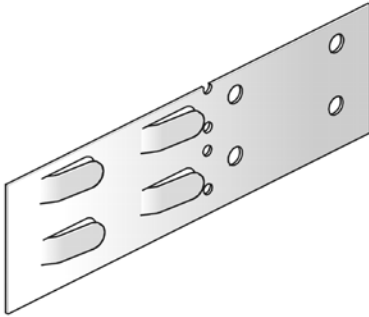

Standard finish	Pre-galvanised
Optional finish PE	Coating

HD	Reference	mm	mm	mm	mm	kg/piece		Stock	Unit
-	V60	52	180		-	0.090	48	✓	piece

Fix with:									
HD	VM6.10	-	-	M6	10	0.008	100	✓	piece

To order per full packaging.
Minimum number bolts and nuts: 2 pieces.

V85

Joiner for fast mounting

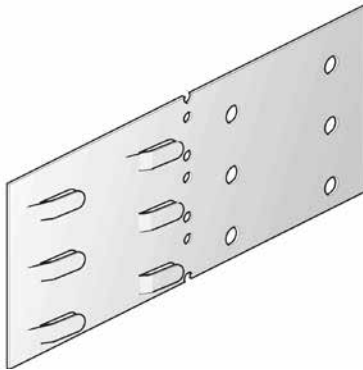

Standard finish	Pre-galvanised
-----------------	----------------

HD	Reference	mm	mm	mm	mm	kg/piece		Stock	Unit
-	V85	77	180		-	0.130	48	✓	piece

Fix with:									
HD	VM6.10	-	-	M6	10	0.008	100	✓	piece

To order per full packaging.
Minimum number bolts and nuts: 2 pieces.

V35.200

Joining plate

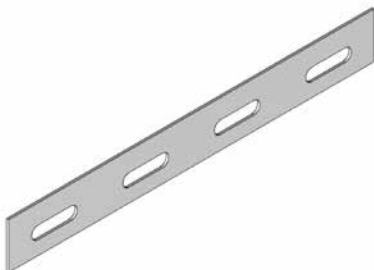

Standard finish	Pre-galvanised
Optional finish HD	Hot-dip galvanised
Optional finish PE	Coating

HD	Reference	mm	mm	mm	mm	kg/piece		Stock	Unit
HD	V35.200	25	200		-	0.040	48	✓	piece

Fix with:									
HD	VM6.10	-	-	M6	10	0.008	100	✓	piece

To order per full packaging.
Minimum number bolts and nuts: 2 pieces.

V60.200

Joining plate

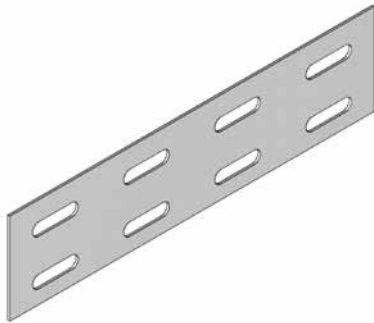

Standard finish	Pre-galvanised
Optional finish HD	Hot-dip galvanised
Optional finish PE	Coating

HD	Reference	↑ mm	↔ mm	↔ mm	↔ mm	kg/piece	📦	Stock	Unit
HD	V60.200	50	200		-	0.080	48	✓	piece
Fix with:									
HD	VM6.10	-	-	M6	10	0.008	100	✓	piece

To order per full packaging.
Minimum number bolts and nuts: 4 pieces.

V85.200

Joining plate

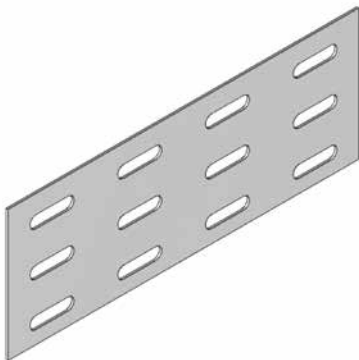

Standard finish	Pre-galvanised
Optional finish HD	Hot-dip galvanised
Optional finish PE	Coating

HD	Reference	↑ mm	↔ mm	↔ mm	↔ mm	kg/piece	📦	Stock	Unit
HD	V85.200	75	200		-	0.130	48	✓	piece
Fix with:									
HD	VM6.10	-	-	M6	10	0.008	100	✓	piece

To order per full packaging.
Minimum number bolts and nuts: 4 pieces.

V110.200

Joiner

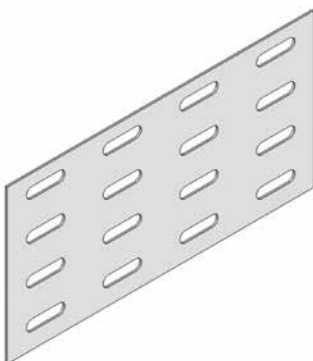

Standard finish	Pre-galvanised
Optional finish HD	Hot-dip galvanised
Optional finish PE	Coating

HD	Reference	↑ mm	↔ mm	↔ mm	↔ mm	kg/piece	📦	Stock	Unit
HD	V110.200	100	200		-	0.170	48	✓	piece
Fix with:									
HD	VM6.10	-	-	M6	10	0.008	100	✓	piece

To order per full packaging.
Minimum number bolts and nuts: 8 pieces.

KPW

Joiner for wide-span

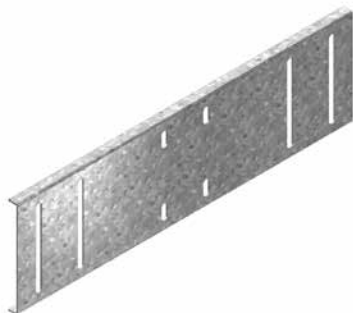

Standard finish	Pre-galvanised
Optional finish HD	Hot-dip galvanised
Optional finish PE	Coating

HD	Reference	↑ mm	↔ mm	↔ mm	↔ mm	kg/piece	📦	Stock	Unit
HD	KPW	115	400			0.590	24	✓	piece
Fix with:									
HD	VM6.10	-	-	M6	10	0.008	100	✓	piece

To order per full packaging.
Minimum number bolts and nuts: 8 pieces.

LV

Supporting corner

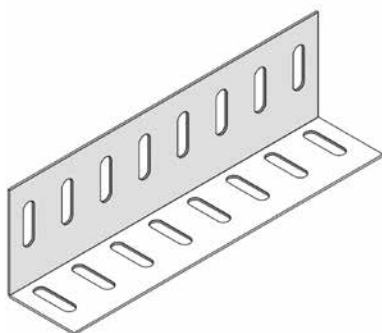

Standard finish	Pre-galvanised
Optional finish HD	Hot-dip galvanised
Optional finish PE	Coating

HD	Reference	↑ mm	↔ mm	↔ mm	↔ mm	kg/piece	📦	Stock	Unit
HD	LV35	32	20			0.080	24		piece
HD	LV60.85	60	43			0.170	24	✓	piece
HD	LV110	94	58			0.256	24		piece
Fix with:									
HD	VM6.10	-	-	M6	10	0.008	100	✓	piece

To order per full packaging.
Minimum number bolts and nuts: 4 pieces.

KBV

Fast locking for KBSI



Standard finish	Stainless Steel
-----------------	-----------------

HD	Reference	↑ mm	↔ mm	↔ mm	↔ mm	kg/piece	📦	Stock	Unit
-	KBV	-				0.001	100	✓	piece

To order per full packaging.

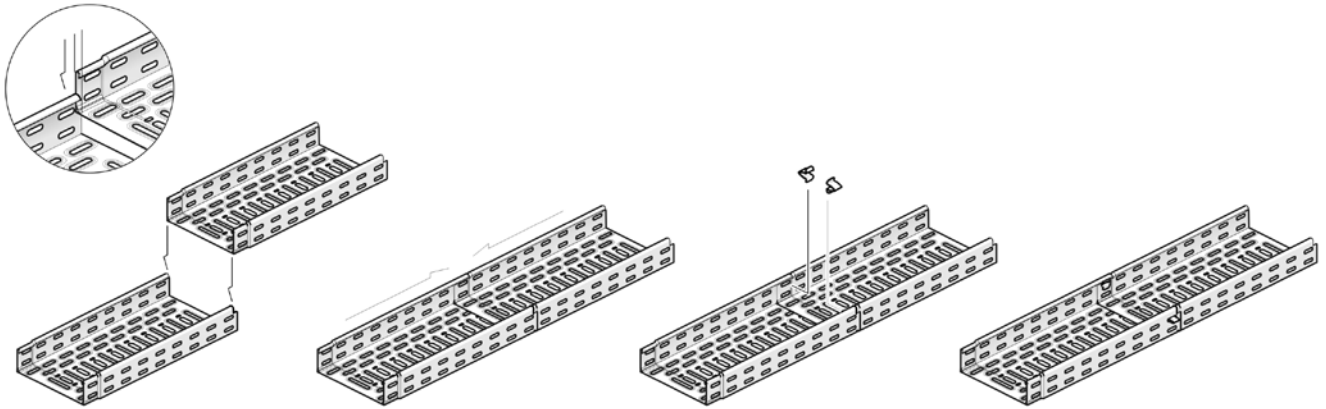
KBSI60**Technical information**

How do you proceed ?

Very simple :

1. Put two lengths together.
2. Slide them into each other.
3. Snap in KBV clips for extra stability and safe locking.
4. Finished !!!

This system offers you various advantages :

1. Lower cost price.
2. Faster mounting.
3. No bolts and nuts required.
4. Fixing with clips.
5. Earthing.
6. Easier fixing thanks to alternative perforations.
7. Better stability thanks to embedded perforations.
8. Better aeration of the cables thanks to embedded perforations.
9. Integrated cable protection thanks to overlapping ends.
10. Smooth finishing touch.
11. Lower stock investment.

KBSM(I)60

Technical information

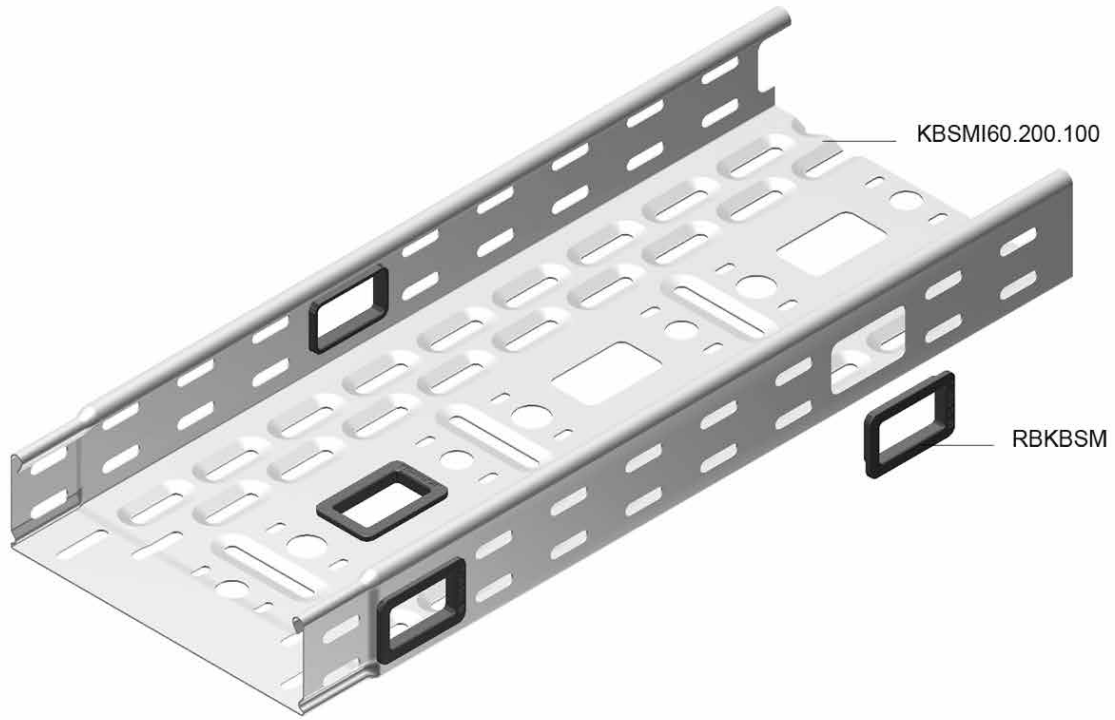

DZ

Technical information

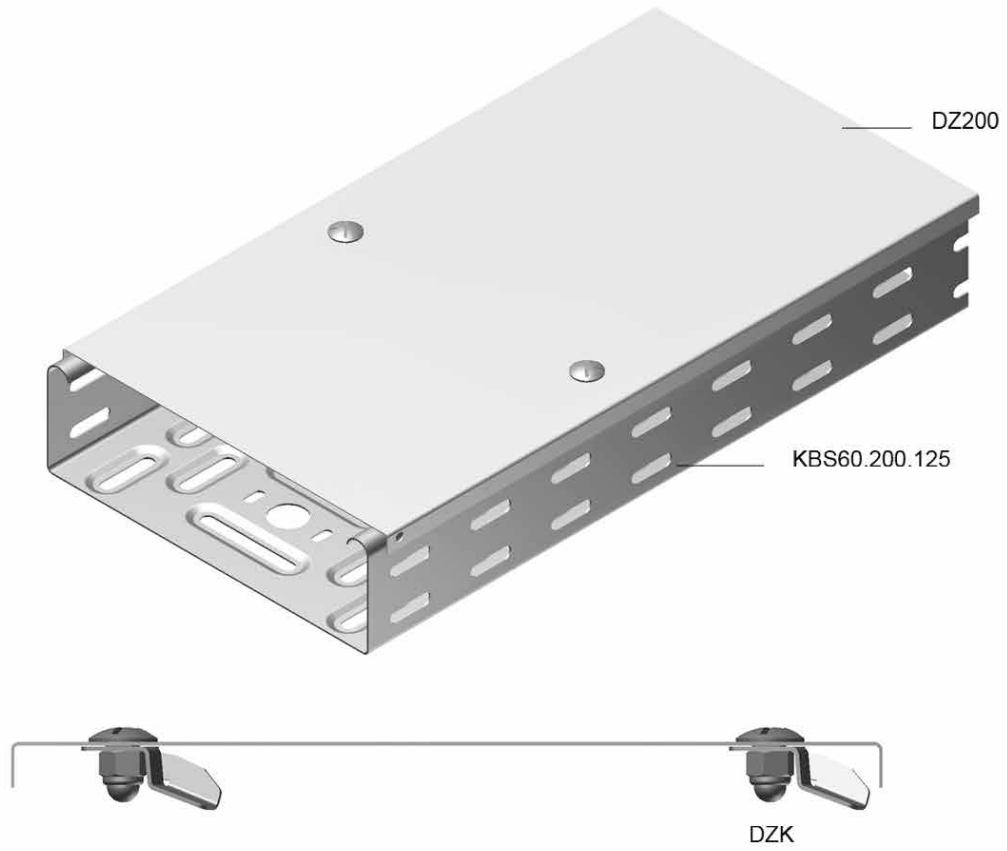

B90

Technical information

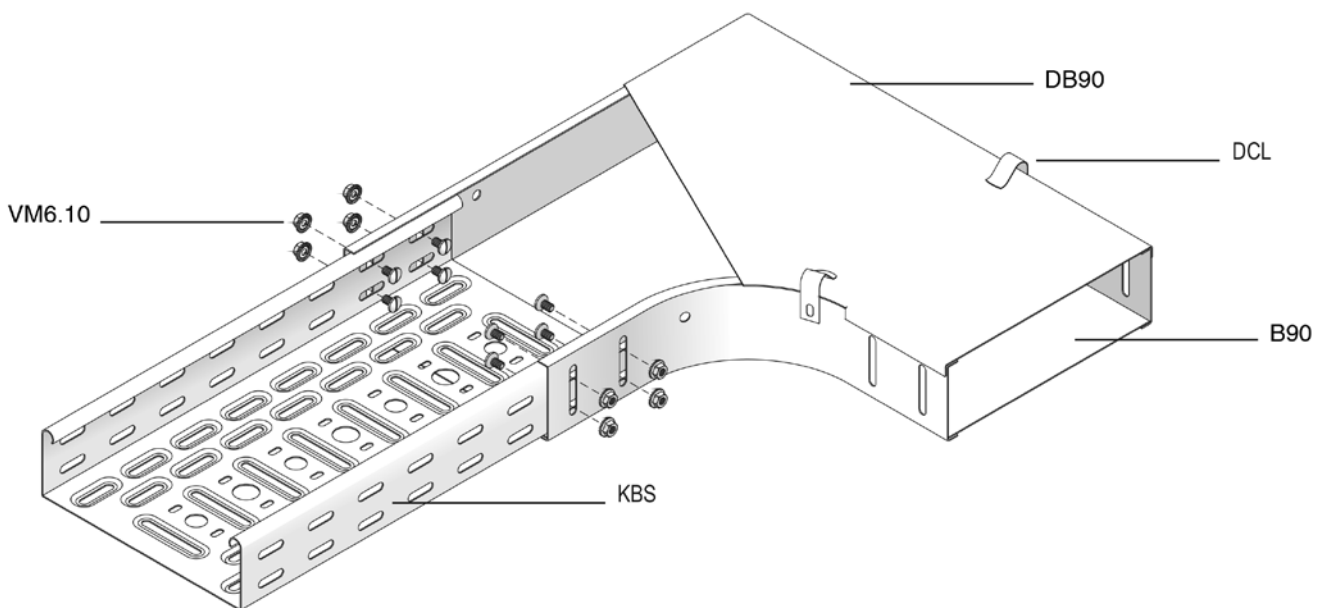

AZH

Technical information

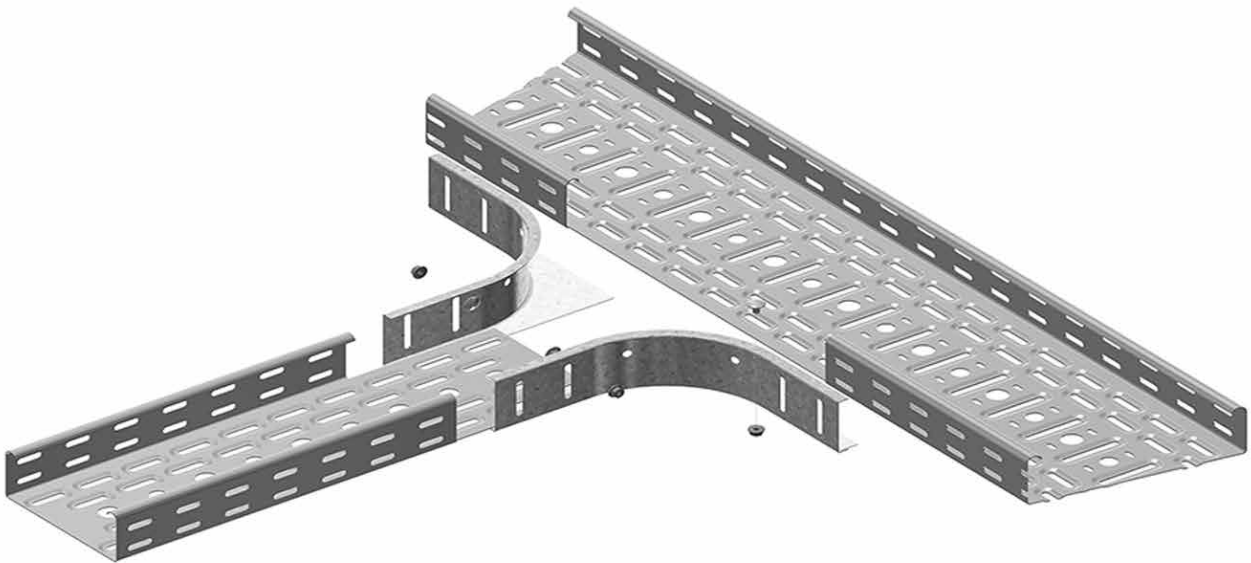

VS

Technical information

